

STELLWERK

SIGNAL TOWER

POSTE D'AIGUILLAGE

SEINHUIS



Art. Nr. 120116

D Vor Beginn des Bastelns sollten Sie sich mit den Teilerahmen und der Anleitung vertraut machen. Im Reklamationsfall gilt die gesetzliche Gewährleistungspflicht. Sollte ein Teil fehlen, übersenden Sie bitte den Teilwunsch und den Kaufbeleg an: Gebr. FALLER GmbH, Kundendienst, Kreuzstraße 9, D-78148 Gütenbach, kundendienst@faller.de. Sollten Sie einmal weitere Ersatzteile benötigen, senden wir Ihnen den benötigten Spritzling, bei Verfügbarkeit, gerne kostenpflichtig zu. Bitte beachten Sie, dass produktionsbedingt Einzelteile übrig bleiben können. Bitte behandeln Sie die Holz- und Kartenteile äußerst vorsichtig und sorgfältig. Die Teile sind stoß- und feuchtigkeitsempfindlich. Kontrollieren Sie den Bausatz vor Beginn auf Vollständigkeit und Unversehrtheit der Teile. Trennen Sie die einzelnen Teile vorsichtig mit einem scharfen Bastelmesser aus dem Teilerahmen. Beachten Sie, dass die Teile bereits nach kurzer Zeit gut aneinander haften und nur schwer wieder voneinander getrennt werden können.

GB Before you start you should familiarize yourself with the parts frame and the instruction manual. In case of any complaint, the legal guarantee obligation shall apply. Should a part be missing, please send the designation of the part required and the receipt documenting your purchase to: Gebr. FALLER GmbH, Kundendienst, Kreuzstraße 9, D-78148 Gütenbach, kundendienst@faller.de. Should you require further spare parts one day, we shall be pleased to send you, with costs, the required sprue, if it is available. Please note that, on grounds of the production process, some single injection molded parts may be superfluous. Please treat the parts very carefully and accurately. The parts are shock-sensitive and moisture-sensitive. Check the kit for completeness of contents and intactness of parts. Carefully separate the parts with a hobby knife from the parts frame. Kindly note, that the parts already stick together after short time and that they can hardly be separated again.

F Avant de commencer le montage, veuillez vérifier les grappes de pièces et consulter la notice de montage. En cas de réclamation, il s'appliquera l'obligation de garantie légale. Au cas où une pièce manquerait, veuillez envoyer la désignation de la pièce souhaitée et le bon d'achat à: Gebr. FALLER GmbH, Kundendienst, Kreuzstraße 9, D-78148 Gütenbach, kundendienst@faller.de. Au cas où vous auriez besoin un jour d'autres pièces détachées, nous vous enverrons volontiers la grappe requise, si elle est disponible, contre paiement. Veuillez noter que, pour des raisons de production, il se peut que des pièces détachées soient superflues. Veuillez manipuler les pièces en bois et carton avec prudence et soin. Les pièces sont sensibles aux chocs et à l'humidité. Avant de commencer l'assemblage, vérifiez que toutes les pièces sont présentes et en bon état. Prélevez soigneusement les pièces du cadre, une par une, avec un couteau de modéliste à lame acérée. Notez que les pièces assemblées deviennent rapidement solitaires et qu'il est difficile de les séparer par la suite. Vérifiez bien la justesse des assemblages !

NL Voordat u met het bouwen van start gaat adviseren wij u de onderdelen te controleren en de bouwbeschrijving te bestuderen. In geval van reclamatie geldt de wettelijke garantieverplichting. Mocht er een onderdeel ontbreken, stuur het verzoek om het gewenste onderdeel en het aankoopbewijs dan naar: Gebr. FALLER GmbH, klantenservice, Kreuzstraße 9, D-78148 Gütenbach, kundendienst@faller.de. Als u ooit meer reserveonderdelen nodig hebt, sturen wij het benodigde gietstuk, indien beschikbaar, graag tegen betaling naar u op. Let op: om productieredenen kunnen losse onderdelen overblijven. Behandel de houten en kartonnen onderdelen s.v.p. voorzichtig en zorgvuldig. De onderdelen kunnen makkelijk beschadigd raken en zijn gevoelig voor vocht. Snijd de onderdelen voorzichtig met een scherp mes uit het onderdelen raamwerk. Houd er s.v.p. rekening mee dat de onderdelen al na korte tijd vast aan elkaar hechten en moeilijk weer van elkaar gescheiden kunnen worden.

Für den Zusammenbau des Modells empfehlen wir folgende FALLER-Artikel: Art. Nr. 170494 + 170687 (liegen nicht bei).
For the assembly of the kit we recommend following FALLER products: Art. Nr. 170494 + 170687 (not included).
Pour l'assemblage du modèle, nous vous recommandons les articles FALLER suivants: Art. Nr. 170494 + 170687 (non jointe).
Om dit model te bouwen adviseren wij de volgende FALLER producten: Art. Nr. 170494 + 170687 (niet bijgevoegd).

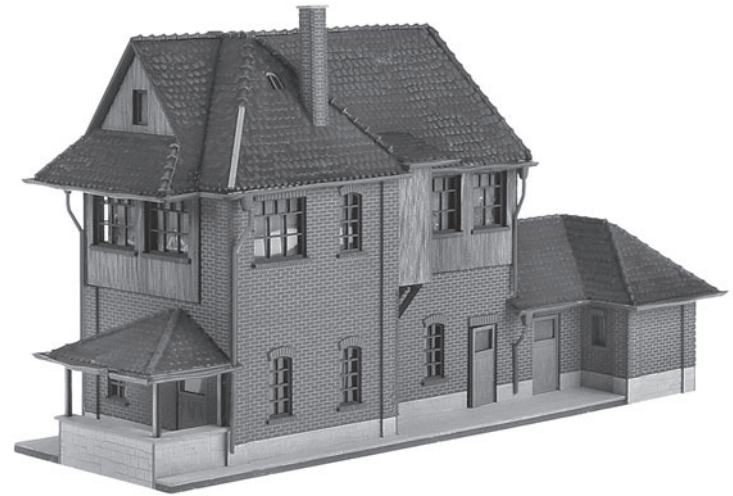

Inhalt	Spritzlinge	1	1 x	4	1 x	7	1 x	10	1 x
Contents	Sprues	2	1 x	5	1 x	8	1 x	11	1 x
Contenu	Moulages	3	1 x	6	1 x	9	1 x	12	1 x
Inhoud	Gietstukken								

Sa. Nr. 120 116 3

Art. Nr. 170490 | 170492 | 170494
FALLER SUPER-EXPERT | EXPERT | LASER-CUT



Art. Nr. 170688
SPEZIALSEITENSCHNEIDER



Art. Nr. 170687
FALLER-BASTELMESSER



2

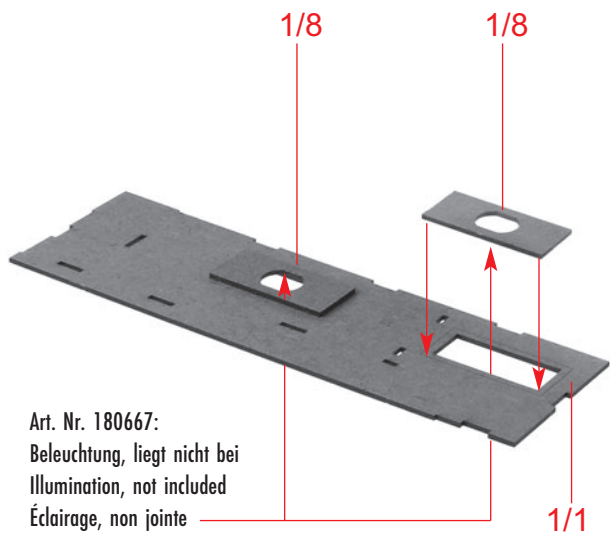

Art. Nr. 180667:
 Beleuchtung, liegt nicht bei
 Illumination, not included
 Éclairage, non jointe
 Verlichting, niet bijgevoegd

(A)

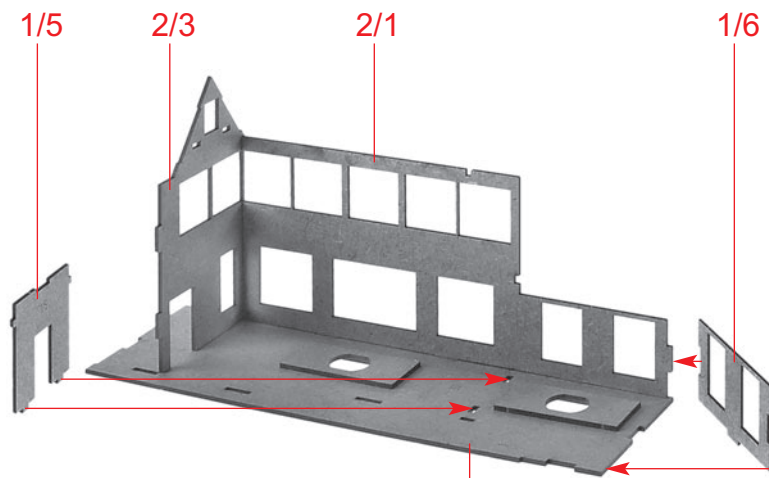

(B)

(A)

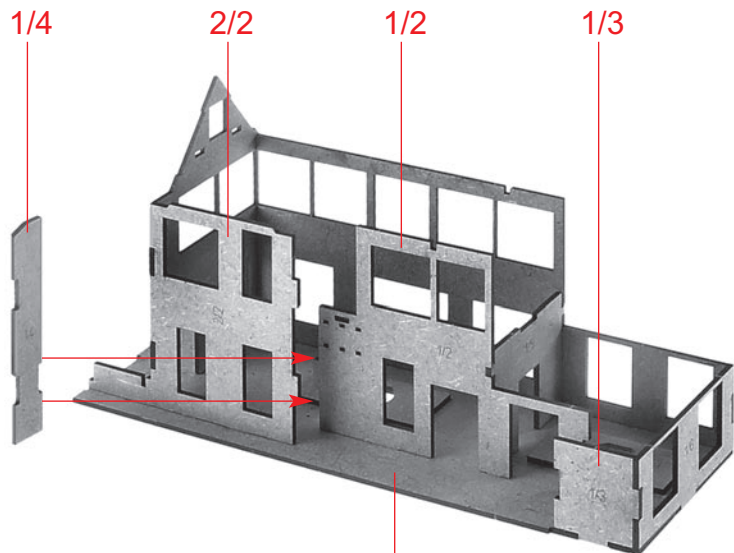

(C)

(B)

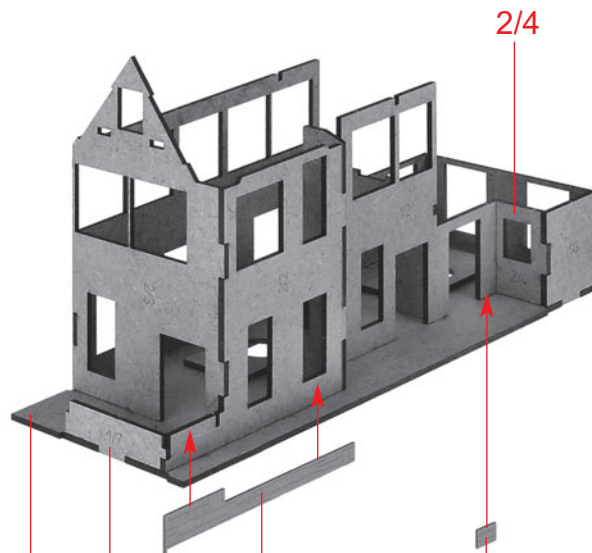

(D)

(C)

1/7

5/11

5/9

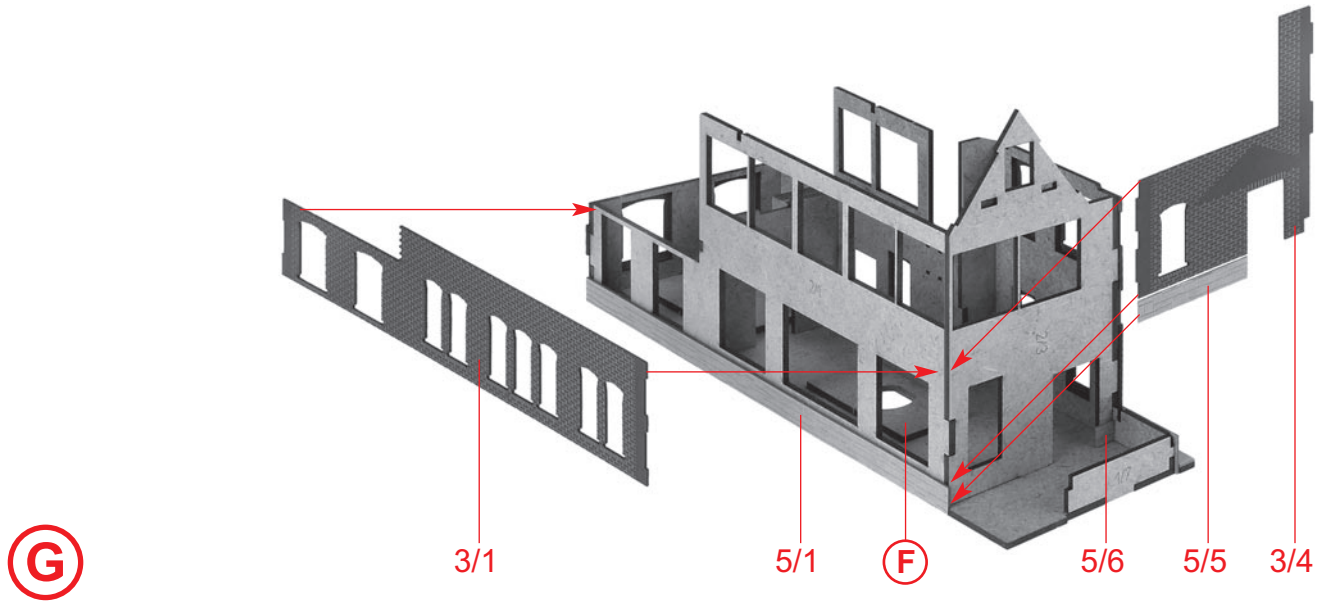
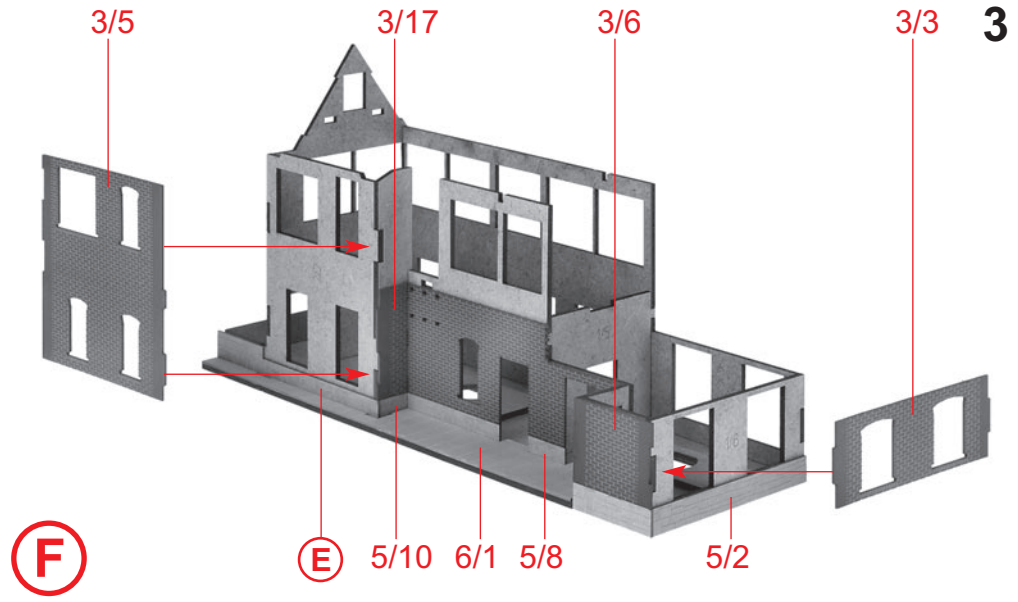
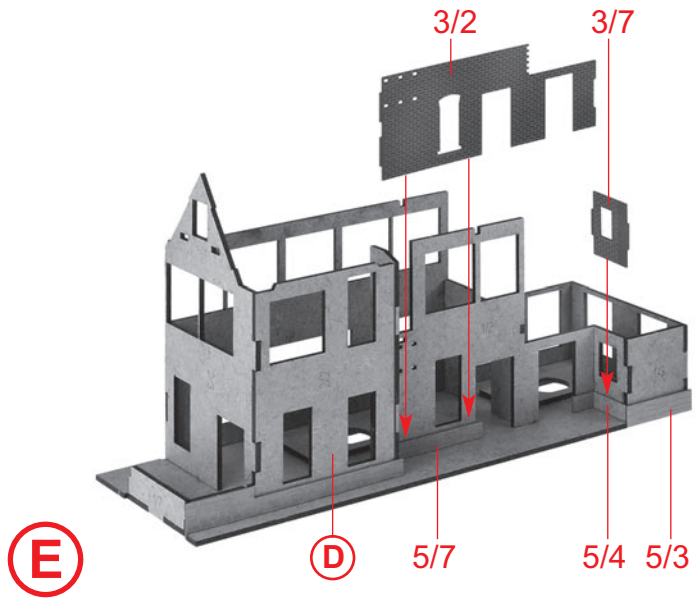

4

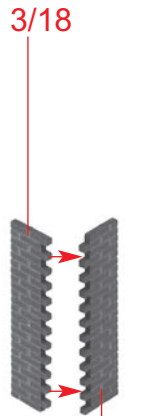
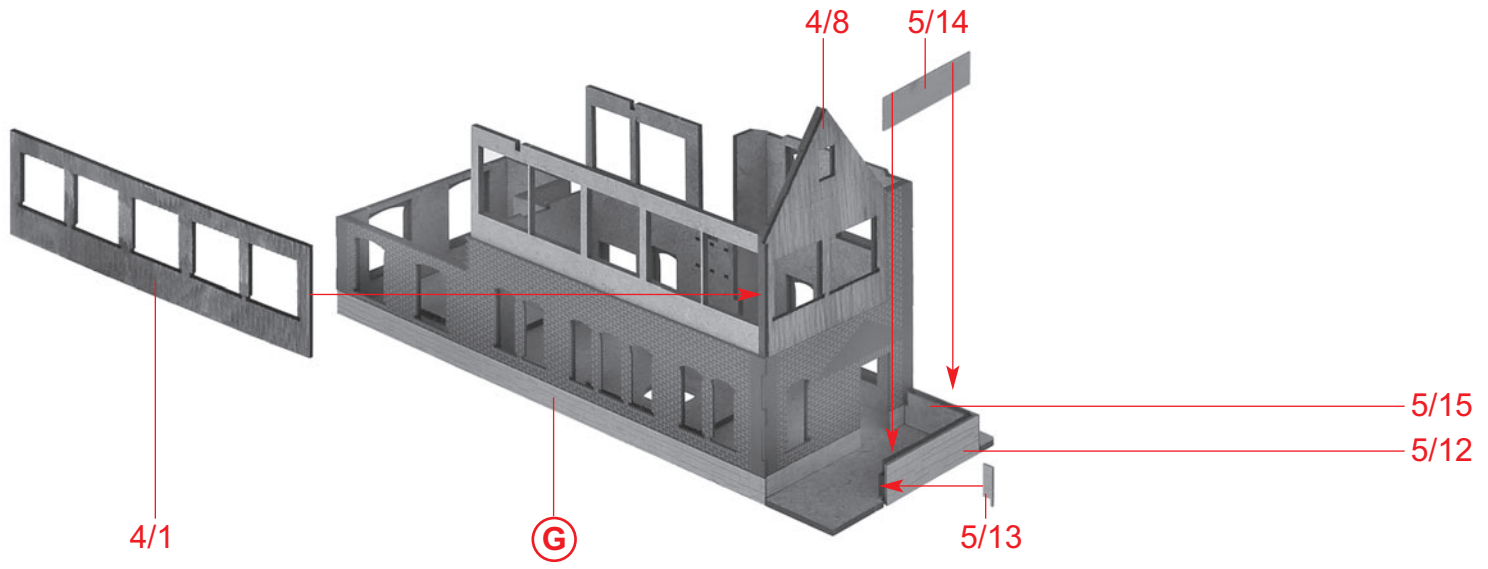

I 2 x 3/19

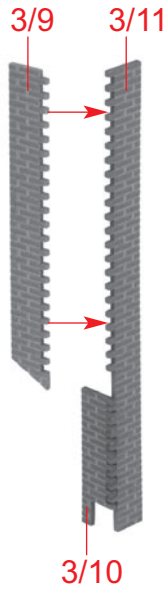

J

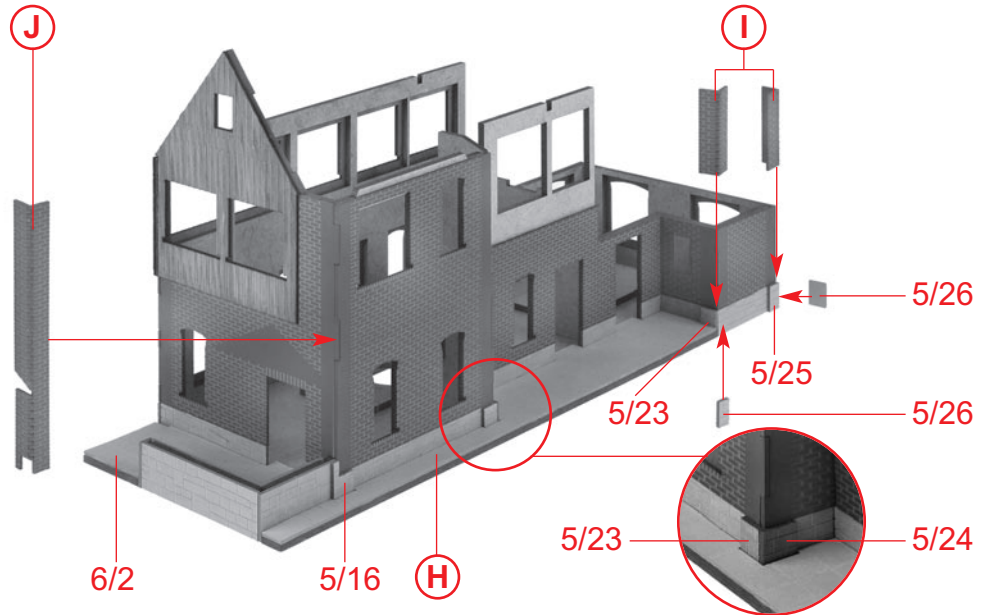

3/12 3/13

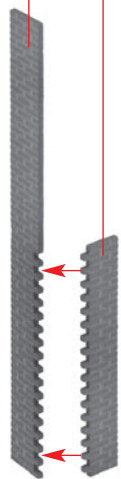

L

4/7

M

K

4/11

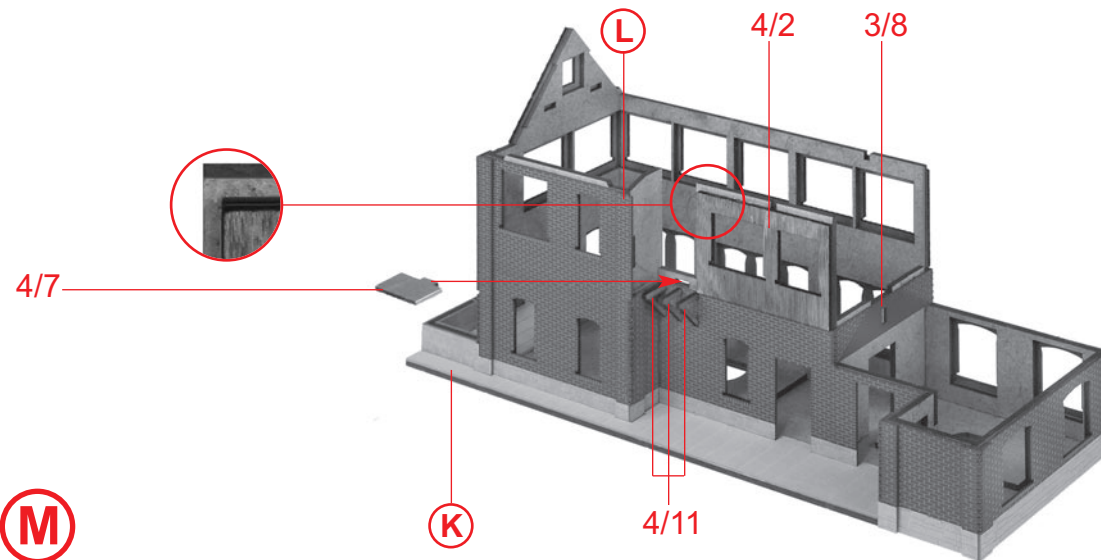

Fensterfolie
Window foil
Feuillet transparent
Vensterfolie

7/3

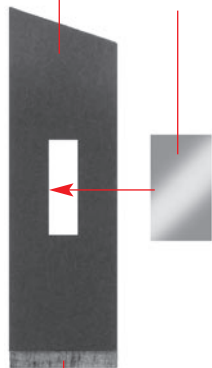

N

4/6

O

M

N

4/5

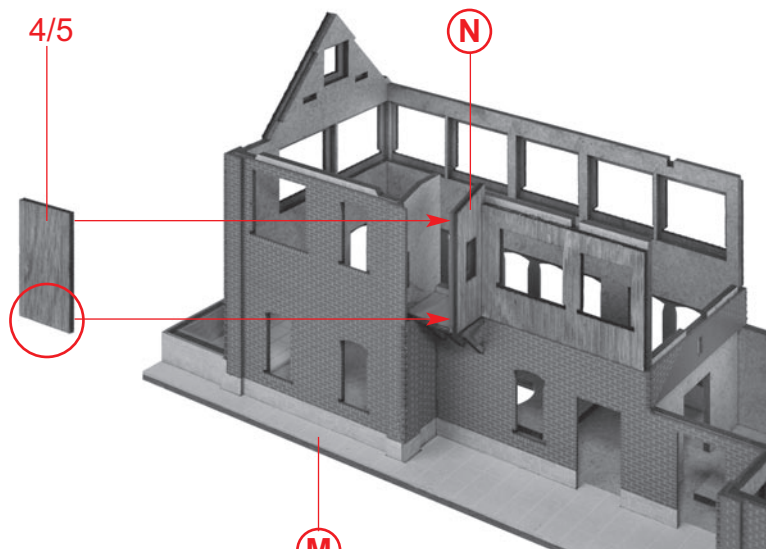

6

Fensterfolie

Die beiliegende Fensterfolie entsprechend der benötigten Größe ausschneiden und vorsichtig mit wenig Klebstoff auf die Rückseite der Fensterrahmen aufkleben.

Window foil

Cut the attached window foil according the illustrations and glue it carefully with a little glue to the rear side of the window frames.

Feuillet transparent pour fenêtres

Découper le feuillet transparent pour fenêtres inclus d'après l'illustration. Coller proprement avec un peu de colle sur la face arrière du cadre des fenêtres.

Vensterfolie

De meegeleverde vensterfolie conform de afbeeldingen uitknippen of uitsnijden en voorzichtig met een beetje lijm op de achterzijde van het raam plakken.

Fensterfolie 9 x 12 mm
Window foil
Feuillet transparent
Vensterfolie



Fensterfolie
Window foil
Feuillet transparent
Vensterfolie

M 1:1
20 x 20 mm

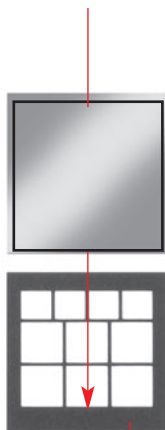

9 x
Q 7/2

Fensterfolie
Window foil
Feuillet transparent
Vensterfolie

M 1:1
10 x 23 mm

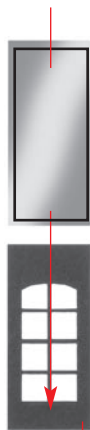

5 x
R 7/8

Fensterfolie
Window foil
Feuillet transparent
Vensterfolie

M 1:1
22 x 23 mm

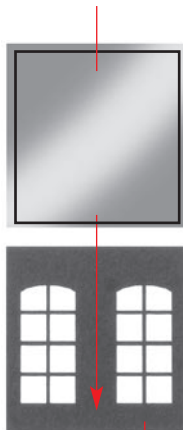

2 x
S 7/9

Fensterfolie
Window foil
Feuillet transparent
Vensterfolie

M 1:1
34 x 23 mm

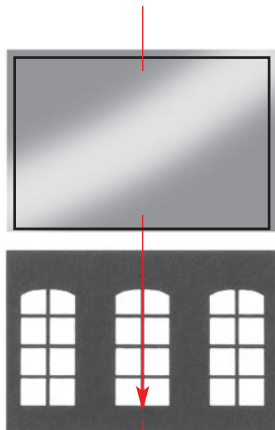

T 7/10

Fensterfolie
Window foil
Feuillet transparent
Vensterfolie

M 1:1
15 x 22 mm

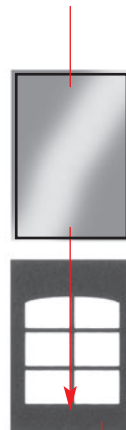

4 x
U 7/4

Fensterfolie
Window foil
Feuillet transparent
Vensterfolie

M 1:1
Deco 1

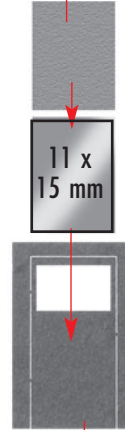

3 x
V 8/1

V

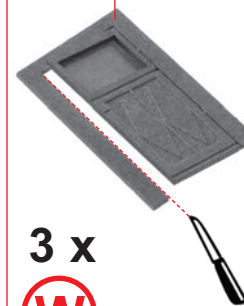

3 x
W

Fensterfolie
Window foil
Feuillet transparent
Vensterfolie

M 1:1
16 x 20 mm



X 7/7

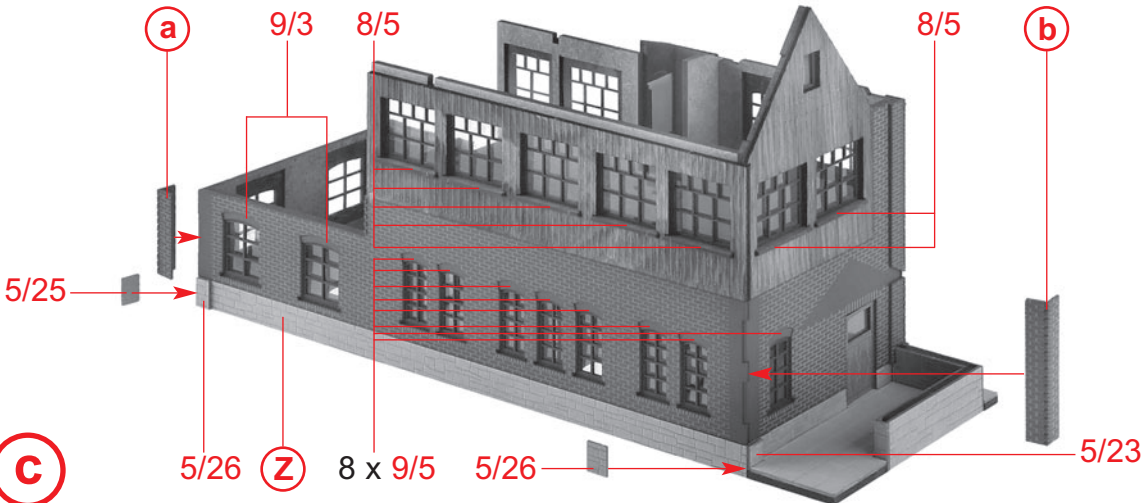
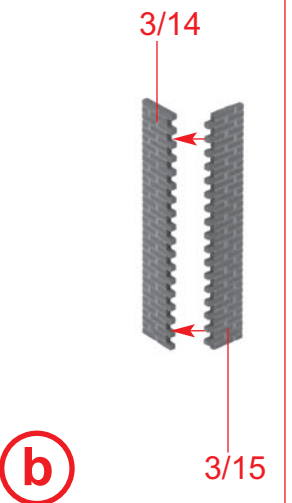
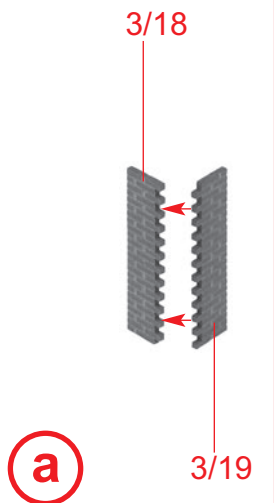
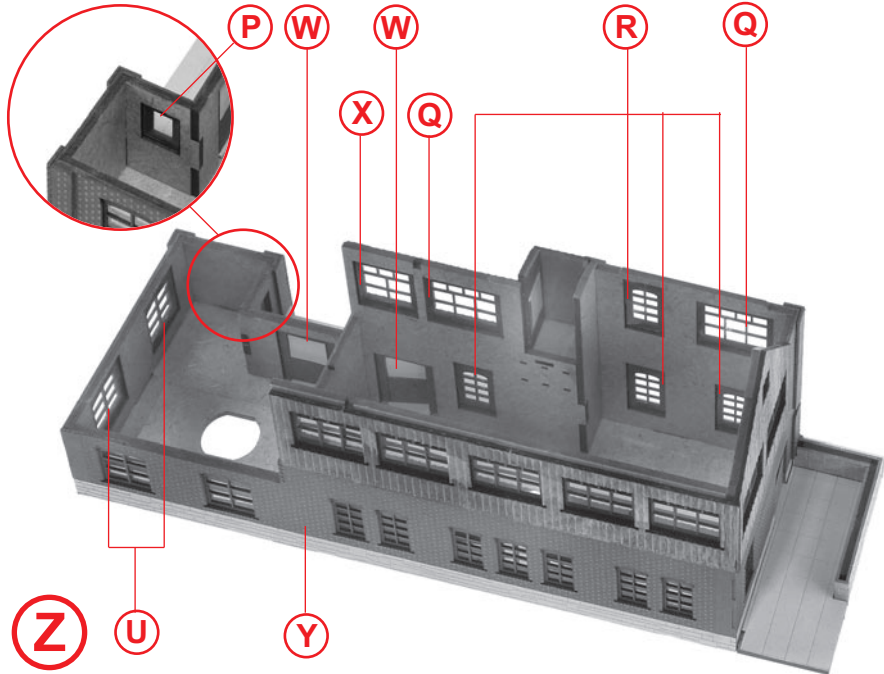
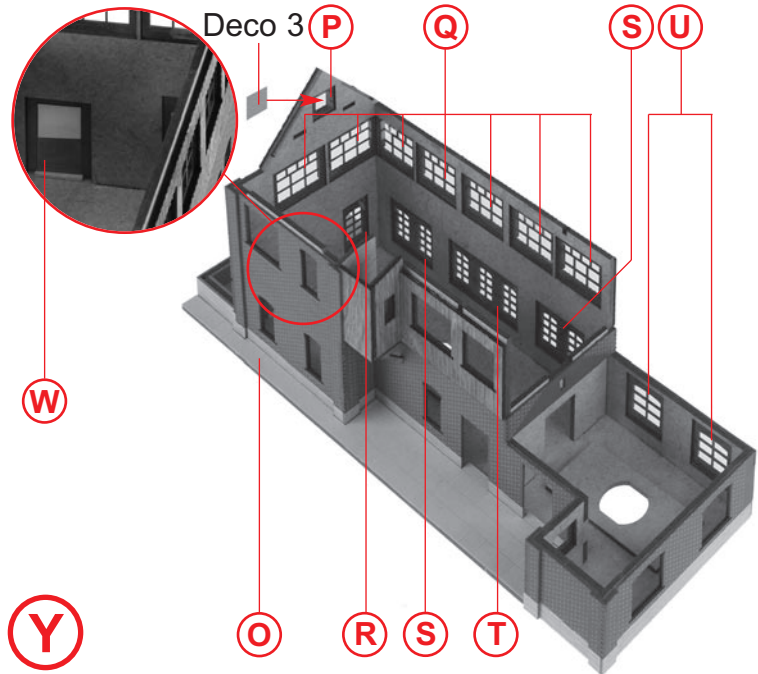

8

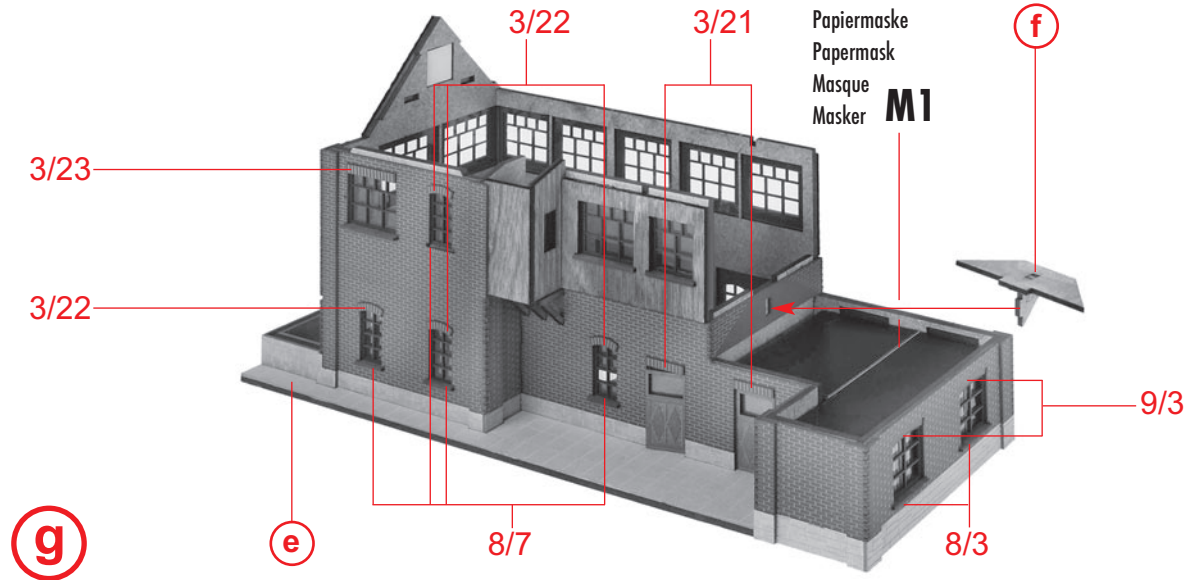
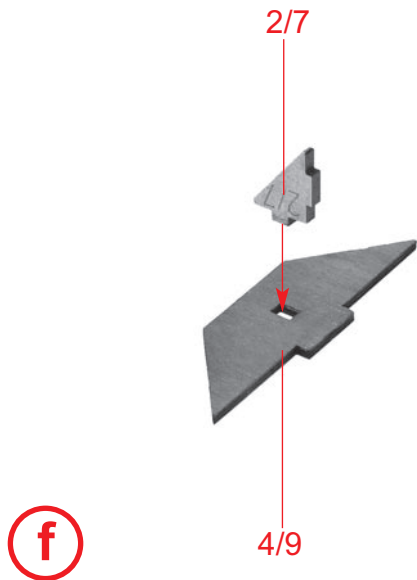
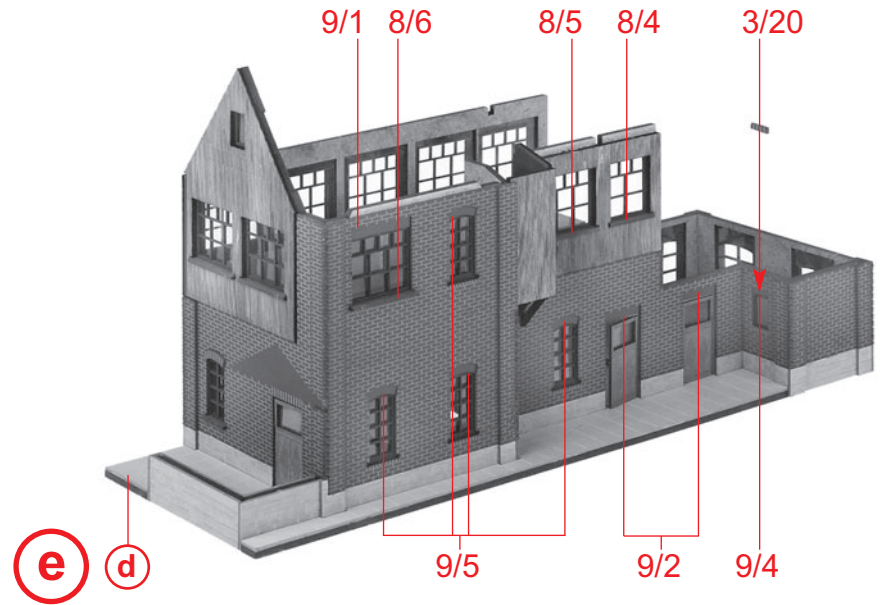
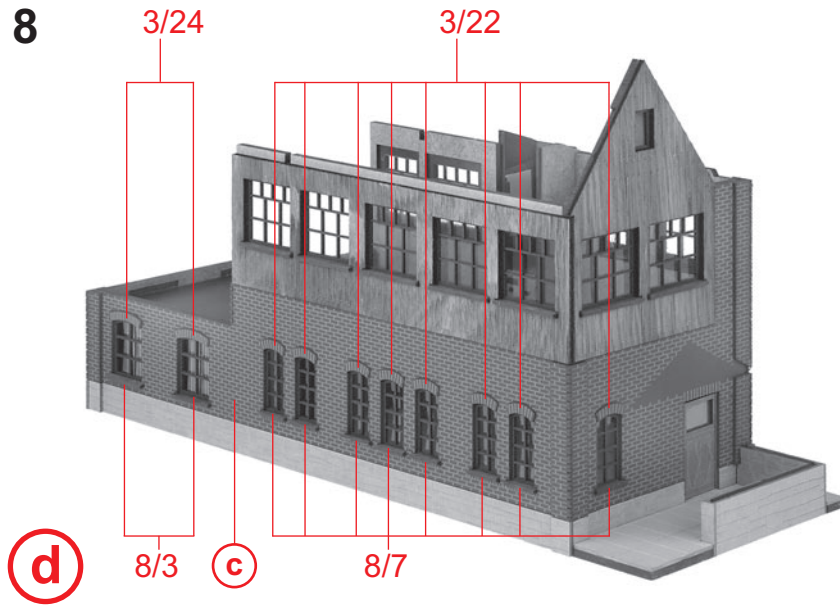

Fensterfolie
Window foil
Feuillet transparent
Vensterfolie

M 1:1

14 x 30 mm

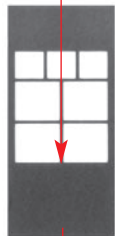

7/6

(h)

2 x

(i)

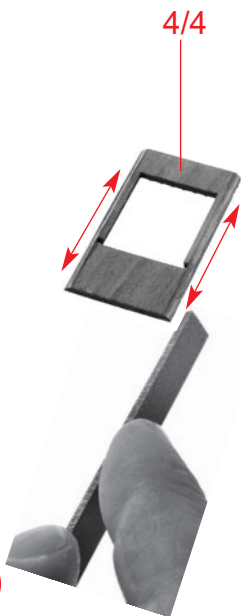

4/4

(h)



2 x

(j)

(i)

(n)

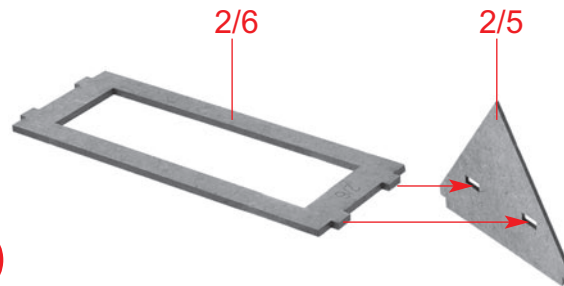

2/6

2/5

Fensterfolie
Window foil
Feuillet transparent
Vensterfolie

M 1:1

15 x 30 mm

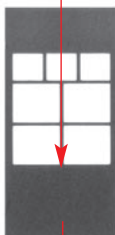

7/5

(k)

2 x

(l)

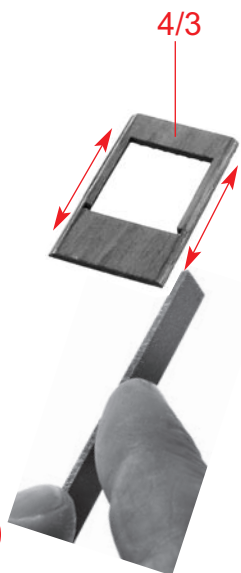

4/3

(k)



(m)

(l)

(o)

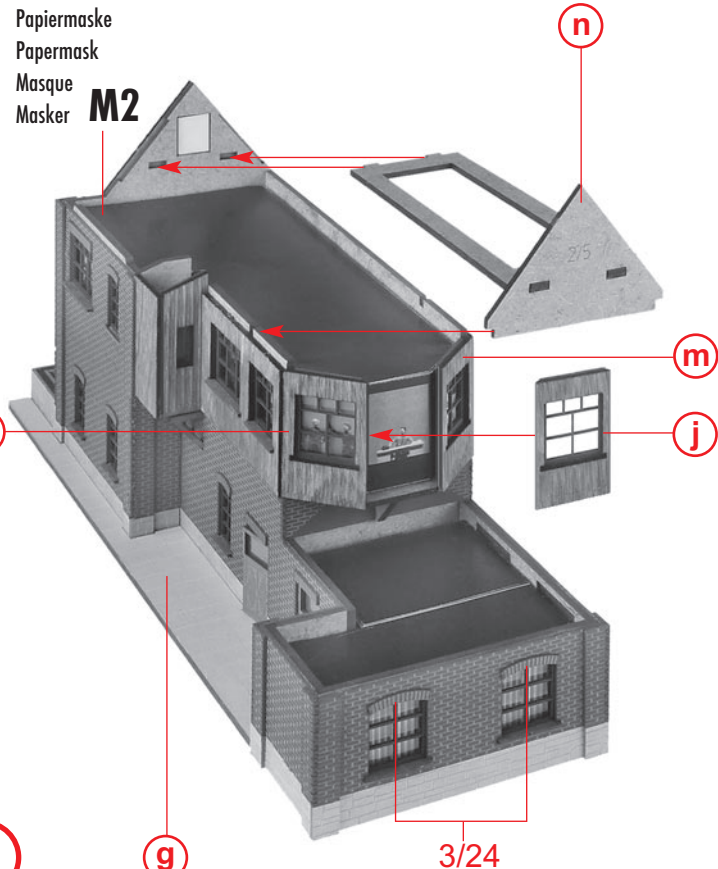

Papiermaske
Papermask
Masque
Masker **M2**

(n)

(m)

(j)

(m)

(g)

3/24

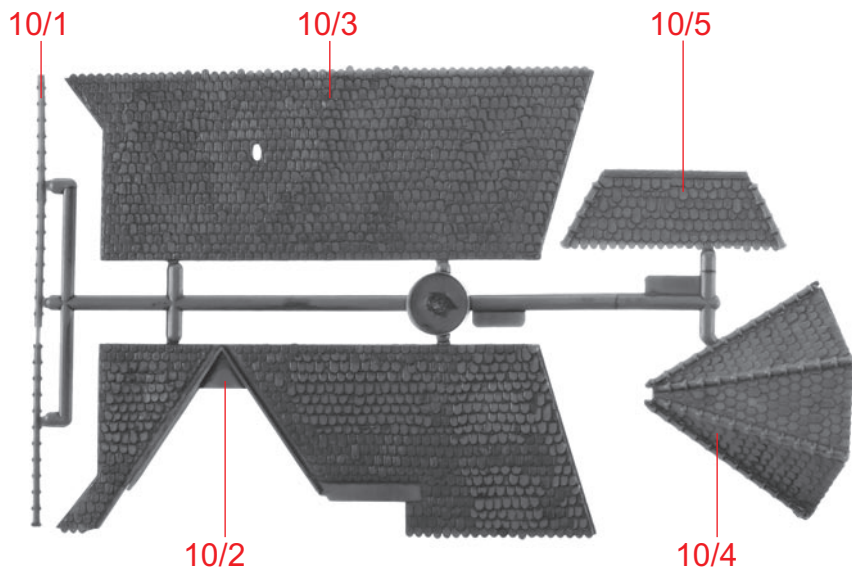
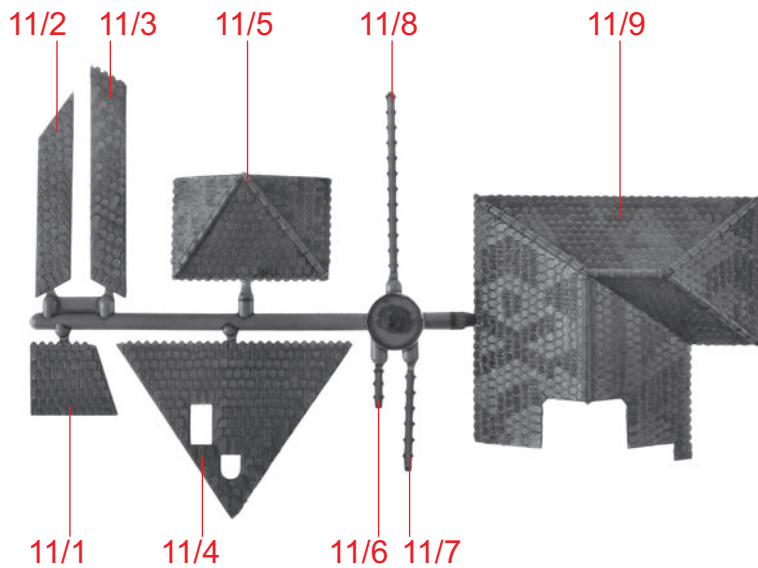
10**10****11**

12/3 12/11 12/6 12/9

12/5 12/12

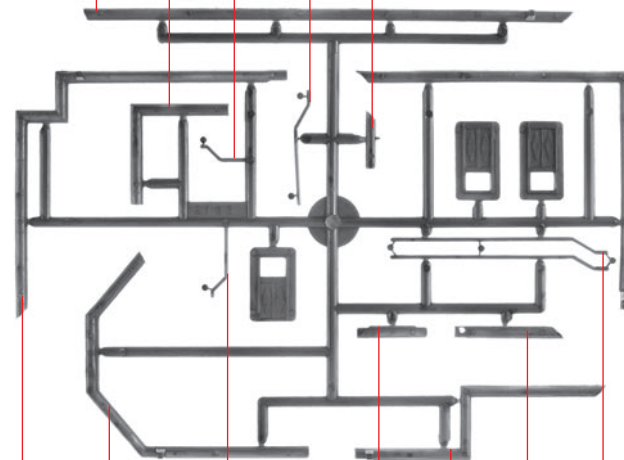

12/2

12

12/1 12/10 12/4 12/8 12/7 12/13

FALLER EXPERT 170492 verwenden.
Use FALLER EXPERT 170492.
Utilisez FALLER EXPERT 170492.
Gebruik FALLER EXPERT 170492.

10/2

10/3

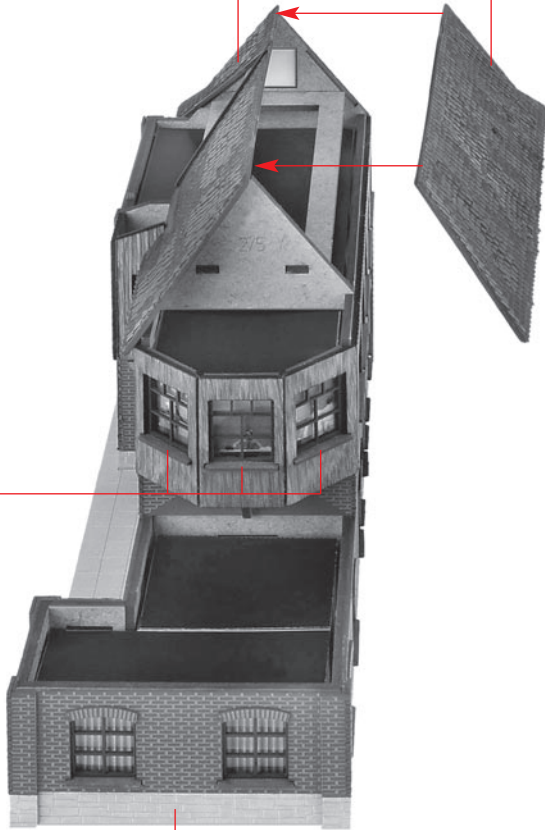

8/4

p

o

FALLER EXPERT 170492 verwenden.
Use FALLER EXPERT 170492.
Utilisez FALLER EXPERT 170492.
Gebruik FALLER EXPERT 170492.

12/9

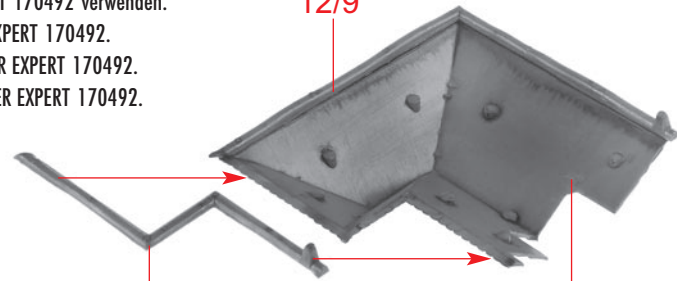

12/8

11/9

q

FALLER EXPERT 170492 verwenden.
Use FALLER EXPERT 170492.
Utilisez FALLER EXPERT 170492.
Gebruik FALLER EXPERT 170492.

10/4

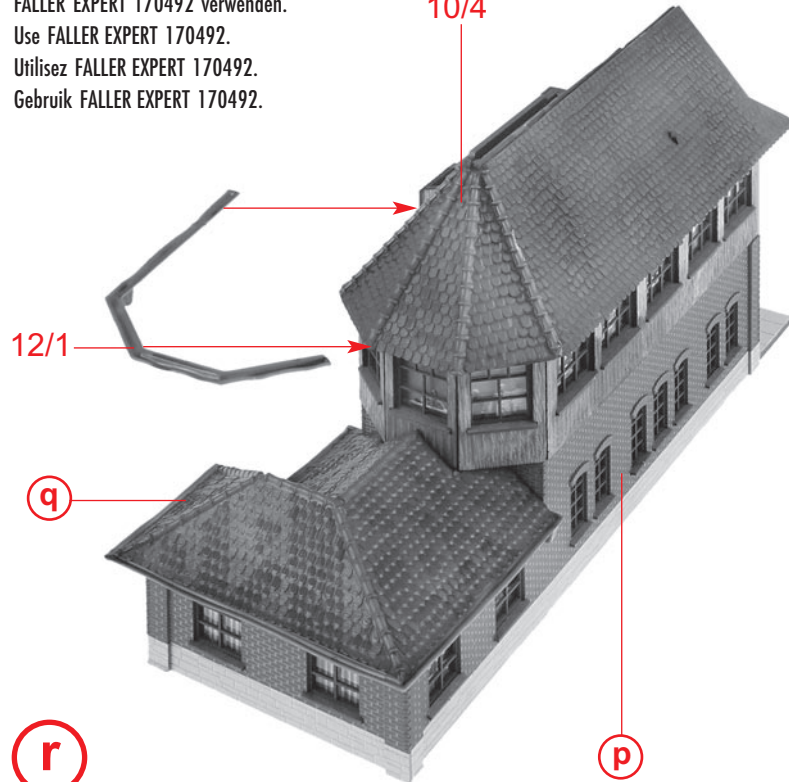

12/1

q

r

p

12

5/27

Fensterfolie
Window foil
Feuillet transparent
Vensterfolie

M 1:1

8 x 9 mm

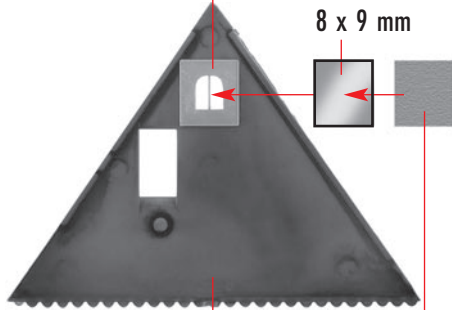

11/4

Deco 2

S

FALLER EXPERT 170492 verwenden.
Use FALLER EXPERT 170492.
Utilisez FALLER EXPERT 170492.
Gebruik FALLER EXPERT 170492.

11/3

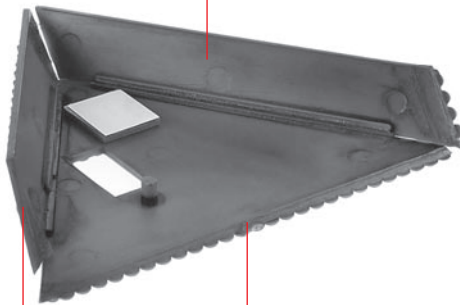

11/2

S

t

4/10

4/10

10/1

11/1

10/5

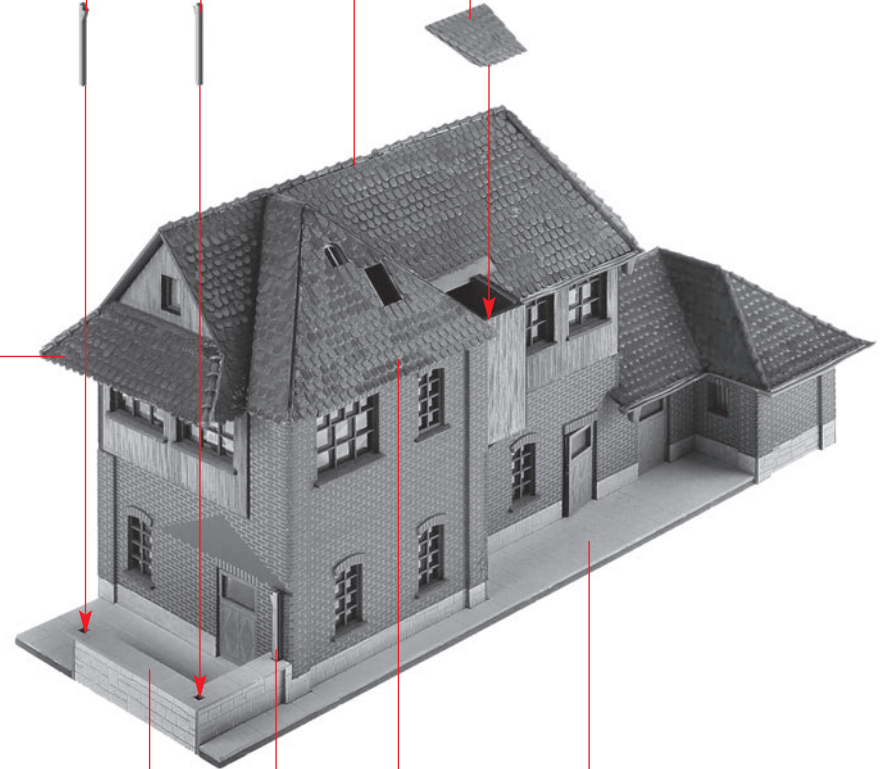

6/3

4/10

t

r

u

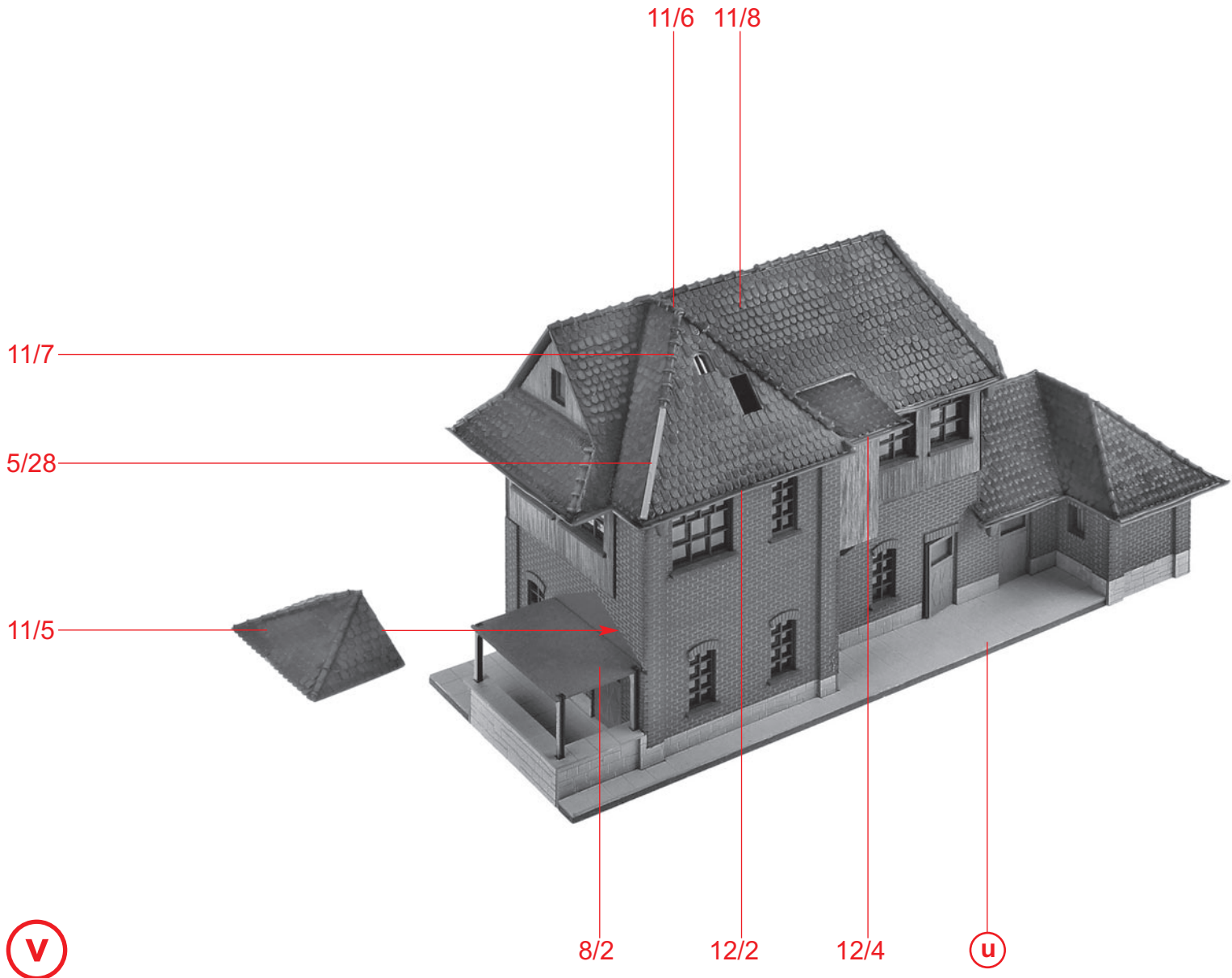

14



3/16

(W) 2 x

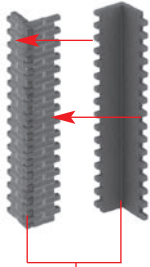

(W)

(X)

6/4



(X)

(Y)

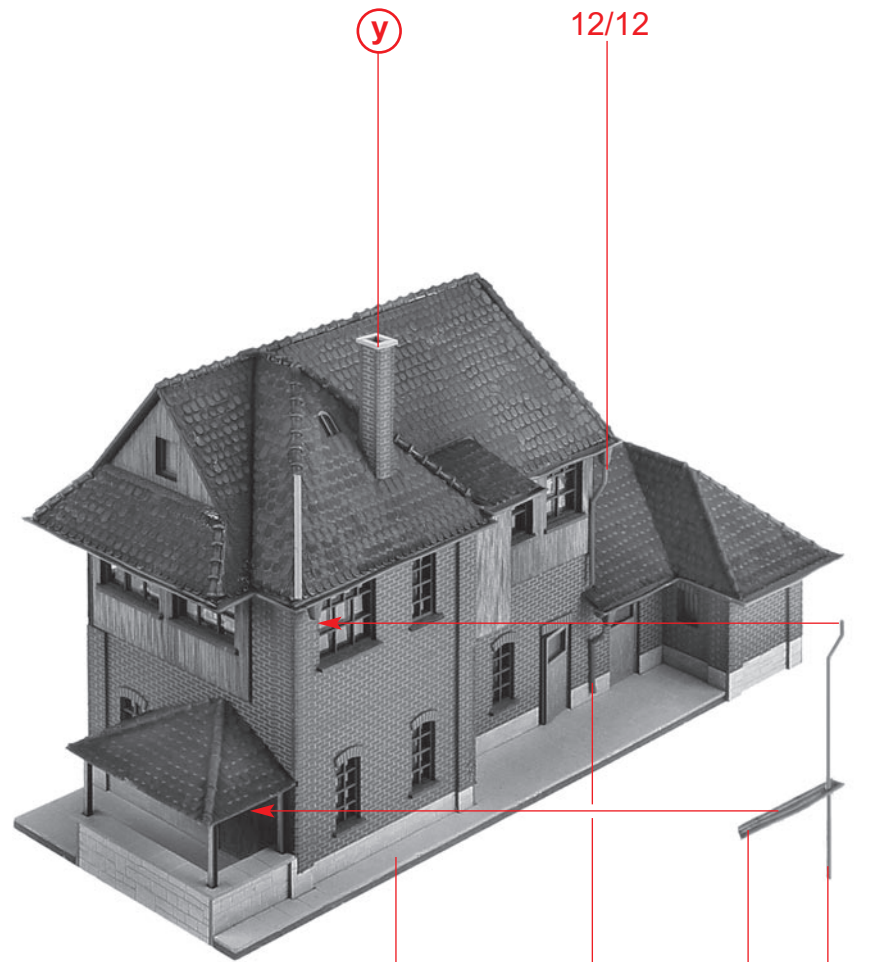

(Y)

12/12

(V)

12/10

12/7

12/13

(Z)

2/8



(A)

5/17

5/18



(B)

(A)

5/19

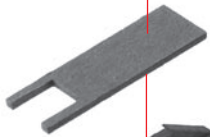

(C)

(B)

5/21

5/20

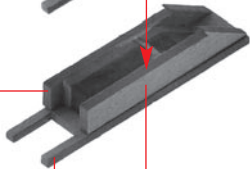

(D)

5/22



(C)

12/3

(D)

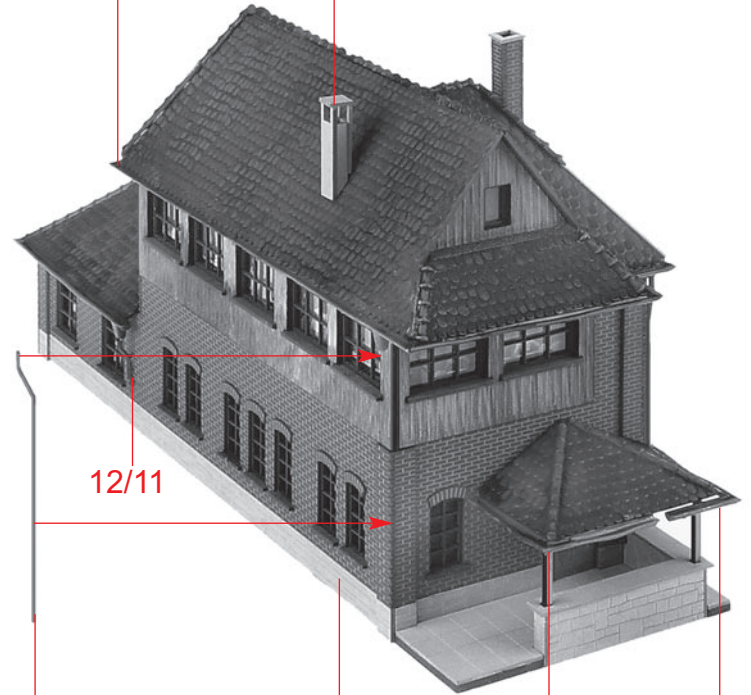

(E)

12/13

(Z)

12/5

12/6

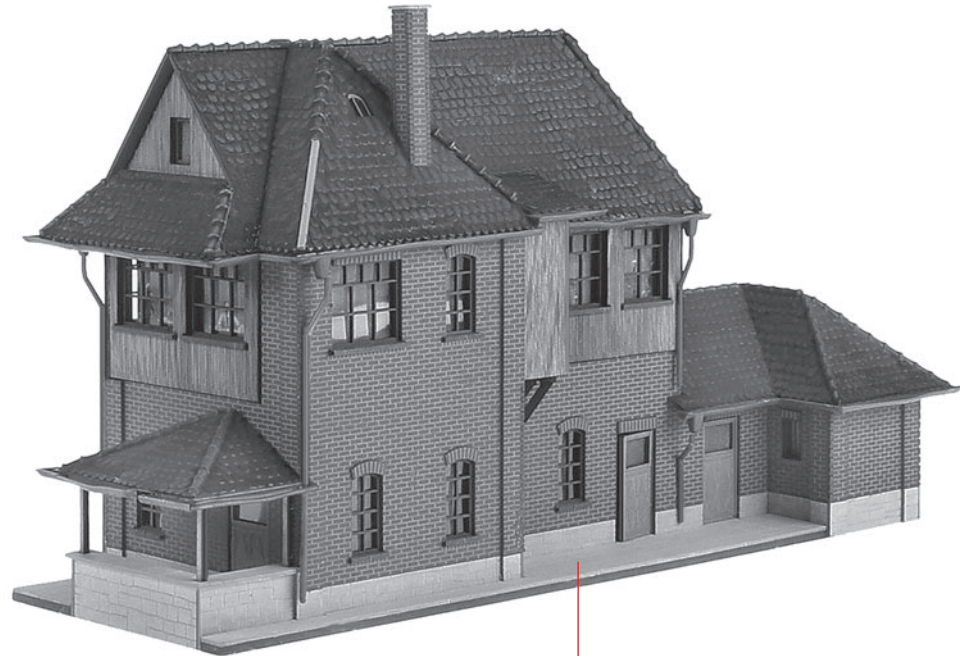

F

E