

SET »NEBENBAHNLOKSCHUPPEN MIT BLOCKSTELLE«



»BRANCH LINE ENGINE SHED WITH BLOCK POST« SET

COFFRET »HANGAR À LOCOMOTIVES DE LIGNE SECONDAIRE AVEC POSTE DE CANTONNEMENT«

SET »LOKAALSPoor LOCLOODS MET BLOKPOST«

Art. Nr. 222108

D

Vor Beginn des Bastelns sollten Sie sich mit den Spritzlingen und der Anleitung vertraut machen. Sollte es einmal vorkommen, dass ein Teil im Bausatz fehlt, kreuzen Sie bitte das fehlende Teil in der Anleitung an und schicken Sie diese bitte an Fa. Gebr. FALLER GmbH, Abt. Kundendienst, kundendienst@faller.de, Kreuzstraße 9, 78148 Gütenbach. Sie erhalten dann umgehend Ersatz. Es kann vorkommen, dass bei einem Bausatz Einzelteile übrig sind.

GB

Before beginning with the assembly please familiarize yourself with the parts and read the instructions carefully. In case of missing parts please indicate these on the instructions leaflet with a circle and return the leaflet to Gebr. FALLER GmbH, kundendienst@faller.de, Kreuzstraße 9, D-78148 Gütenbach, Germany. You will receive the replacement by return. It may happen in a kit that some parts are not required.

F

Avant de commencer le montage de votre maquette bien lire la notice et repérer les grappes. Si une pièce manque dans une boîte, cochez la pièce correspondante sur la notice et renvoyez-la-nous à Gebr. FALLER GmbH, kundendienst@faller.de, Kreuzstraße 9, D-78148 Gütenbach (R.F.A.). Nous vous ferons parvenir la pièce par retour. Dans certains kits, il est possible que certaines pièces ne soient pas utilisées.

NL

Vóór het bouwen zou men de gietstukken en de handleiding moeten bestuderen. Indien onverhoopt een onderdeel aan het bouwpakket ontbreekt, gelieve men het ontbrekende deel in de handleiding aan te kruisen en deze te zenden aan Gebr. FALLER GmbH, kundendienst@faller.de, Kreuzstraße 9, D-78148 Gütenbach. U ontvangt dan omgaand en gratis het ontbrekende onderdeel. Het kan voorkomen dat u bij bepaalde bouwdozen onderdelen overhoudt.

Für den Zusammenbau des Modells empfehlen wir folgende FALLER-Artikel (sind nicht im Bausatz enthalten):
 For the assembly of the kit we recommend following FALLER products (not included in the kit):
 Pour l'assemblage du modèle, nous vous recommandons les articles FALLER suivants (non inclus dans le kit):
 Om dit model te bouwen adviseren wij de volgende FALLER producten (maken geen deel uit van deze bouwset):

Art. Nr. 170492
FALLER-EXPERT

Flüssigkleber in Plastikflasche mit Spezialkanüle für feinste Klebstoffdosierung.

Liquid cement in plastic bottle with canule for very fine dosage.

Colle liquide en bouteille plastique avec bec verseur pour un dosage précis.

Vloeibare lijm in plastic-flescon met doseerbuisje om nauwkeurig te lijmen.



Art. Nr. 170688
SPEZIAL-SEITENSCHNEIDER

zum geratfreien Abtrennen von einstein Spritzteilen. Nur für Polystyrol geeignet.

Special side cutter for cutting off ultra-fine moulded parts without burrs. Only suitable for polystyrene.

Pince coupants spéciale pour couper sans bavure les pièces miniatures moulées par injection. Convient uniquement au polystyrène.

Speciale zijknijplang voor het braamloos afknippen van de fijste gietstukdelen. Alleen geschikt voor polystyrol.

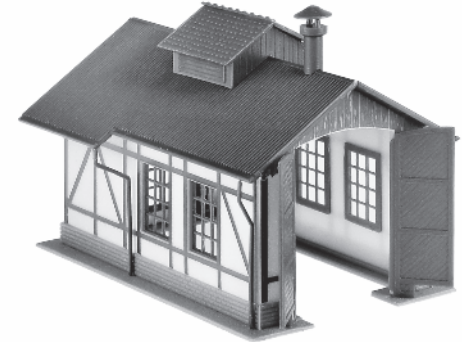

Inhalt	Spritzlinge	01 1 x	01 1 x	04 1 x
Contents	Sprues	02 1 x	01 1 x	01 1 x
Contenu	Moulages	03 1 x	01 1 x	
Inhoud	Gietstukken			

Sa. Nr. 222 108 1

Fensterfolie

Die beiliegende Fensterfolie entsprechend der benötigten Größe ausschneiden und vorsichtig mit wenig Klebstoff auf die Rückseite der Fensterrahmen aufkleben.

Window foil

Cut the attached window foil according the illustrations and glue it carefully with a little glue to the rear side of the window frames.

Feuillet transparent pour fenêtres

Découper le feuillet transparent pour fenêtres inclus d'après l'illustration. Coller proprement avec un peu de colle sur la face arrière du cadre des fenêtres.

Vensterfolie

De meegeleverde vensterfolie conform de afbeeldingen uitknippen of uitsnijden en voorzichtig met een beetje lijm op de achterzijde van het raam plakken.

Fensterfolie
Window foil
Feuillet transparent
Vensterfolie

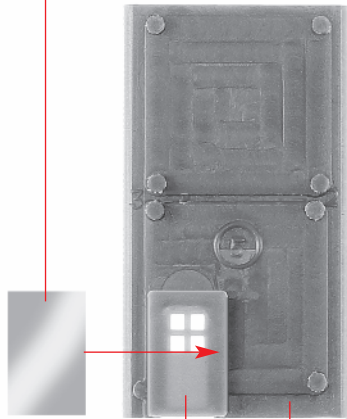

21

5

Fensterfolie
Window foil
Feuillet transparent
Vensterfolie

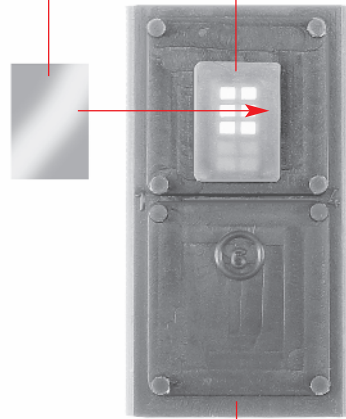

6

Fensterfolie
Window foil
Feuillet transparent
Vensterfolie

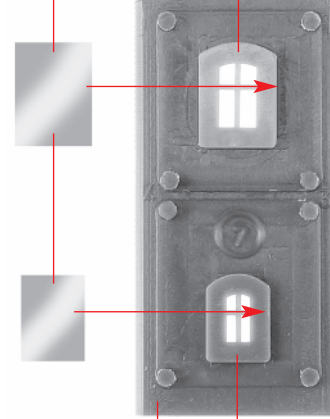

7

18

Fensterfolie
Window foil
Feuillet transparent
Vensterfolie

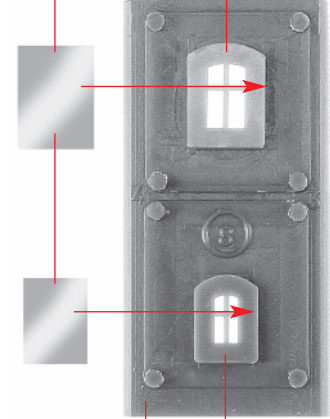

8

18

A

B

C

D

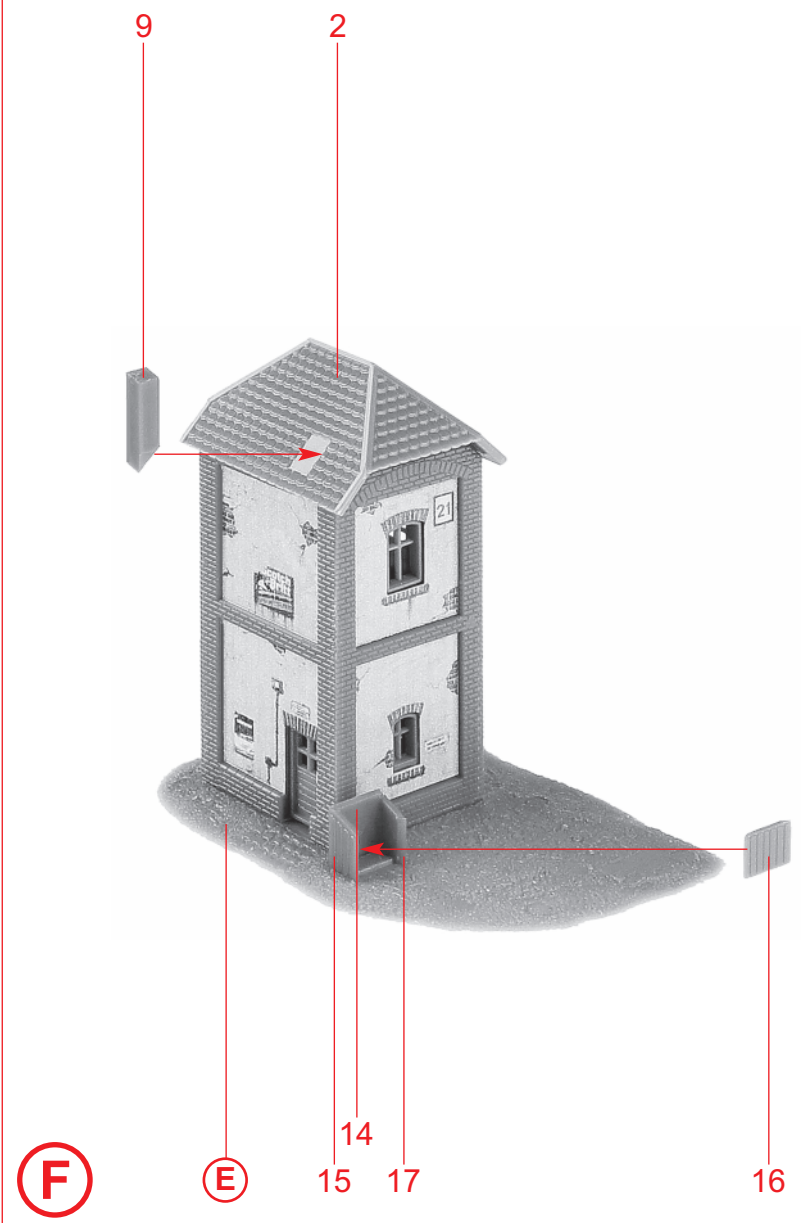
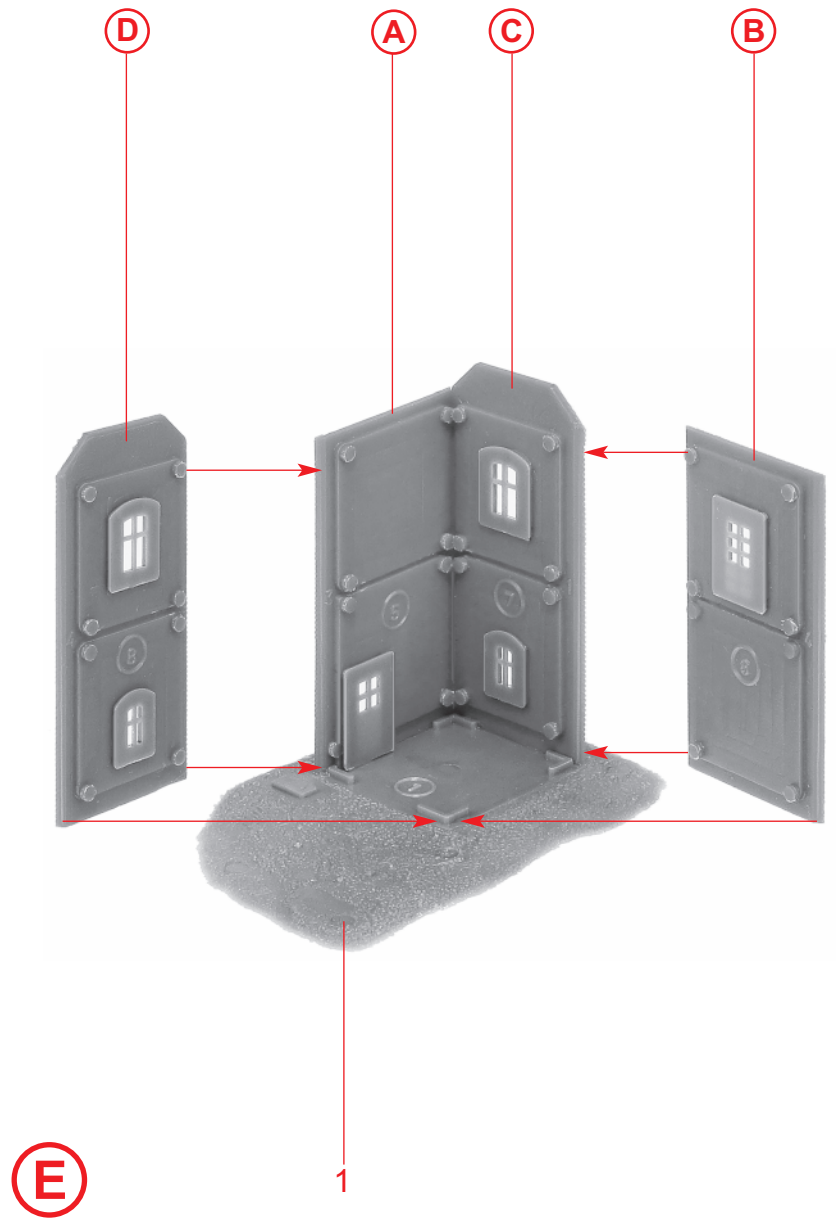

14 15 17

4

4

24

22

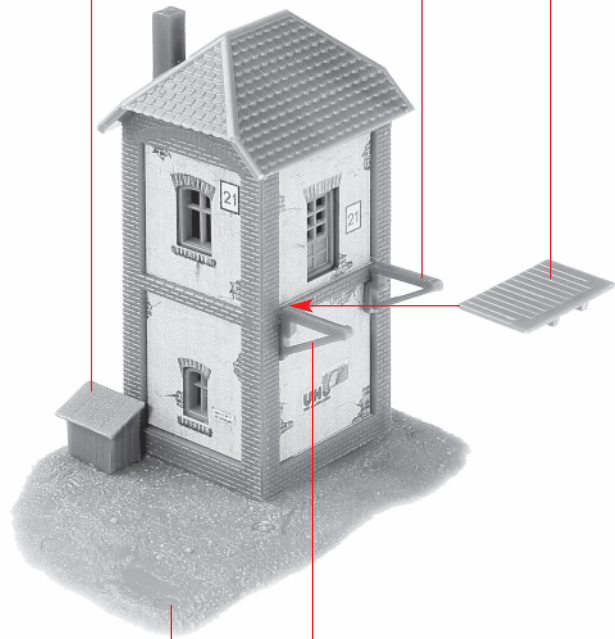

G

F

23

12

25

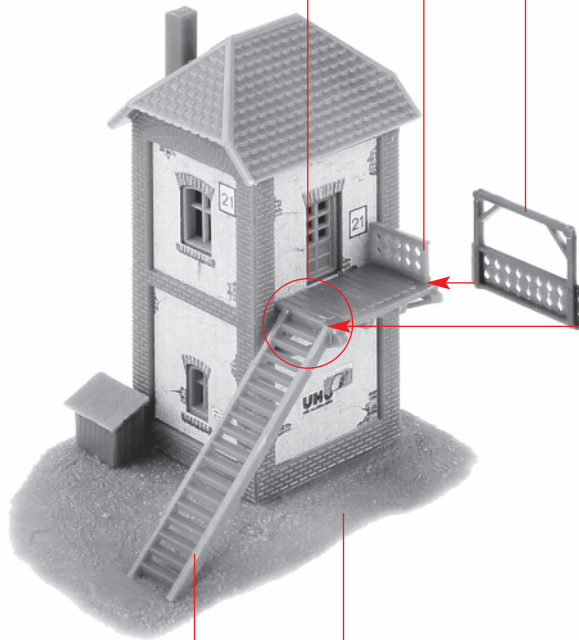
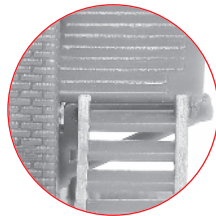

H

13

G

3

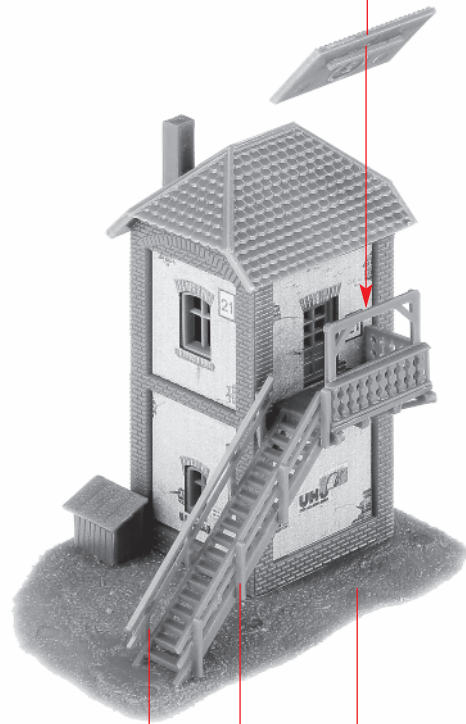

I

10

11

H

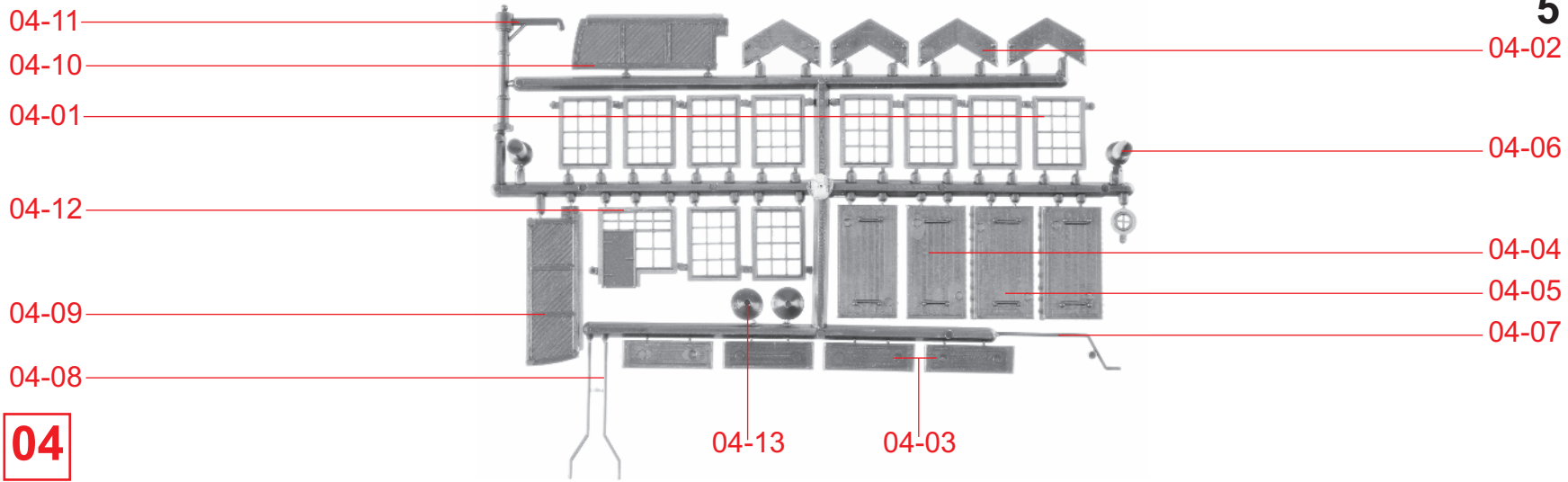

04

Fensterfolie
Window foil
Feuillet transparent
Vensterfolie

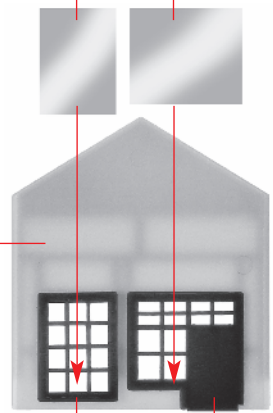

04-01 04-12

J

Fensterfolie
Window foil
Feuillet transparent
Vensterfolie

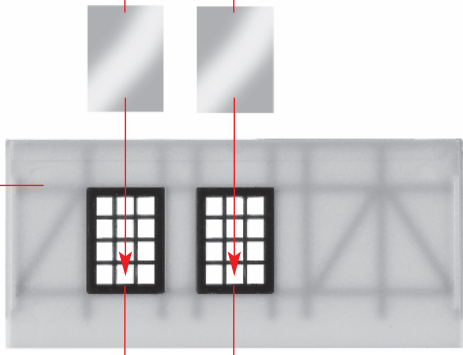

04-01 04-01

K

Fensterfolie
Window foil
Feuillet transparent
Vensterfolie

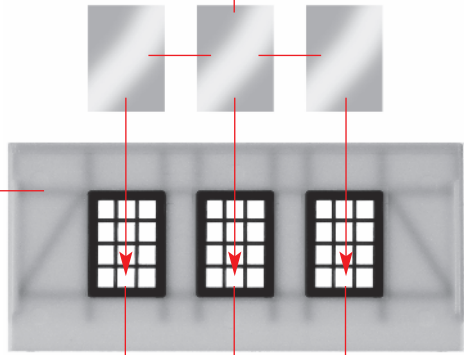

04-01 04-01 04-01

L

6

(K)

(J)

(L)

01-11

04-03

04-03

04-02

01-15

!

(M)

(N)

01-22

01-23

(O)

01-20

(M)

01-21

01-18

04-06

(N)

(P)

01-18

(O)

01-21

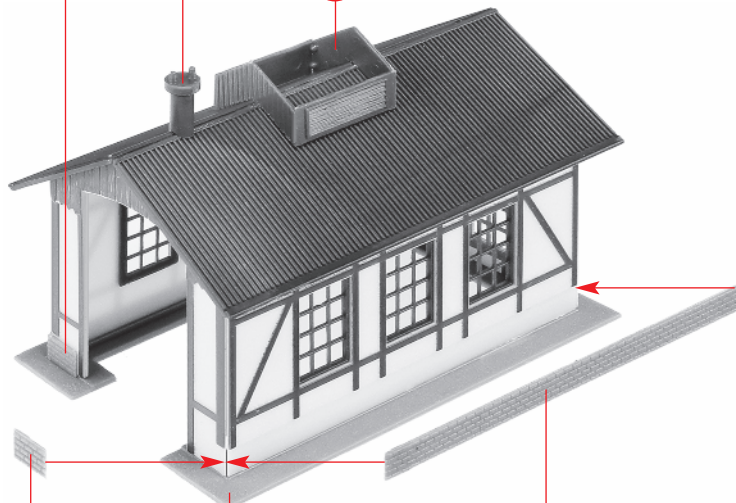
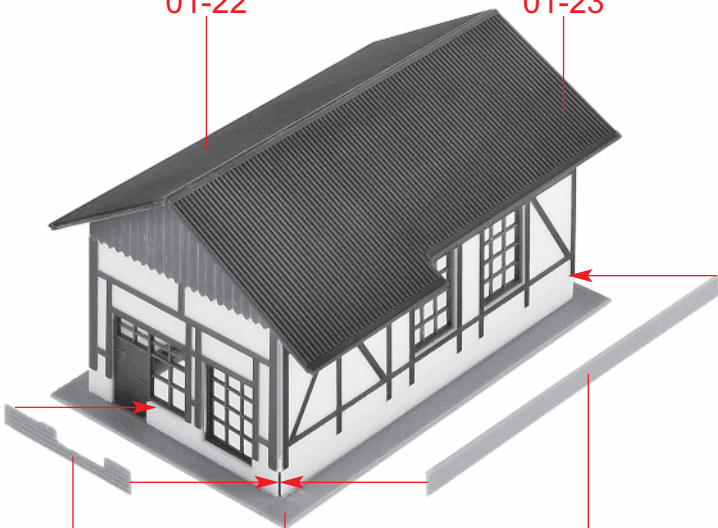
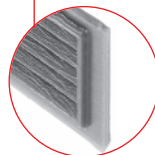
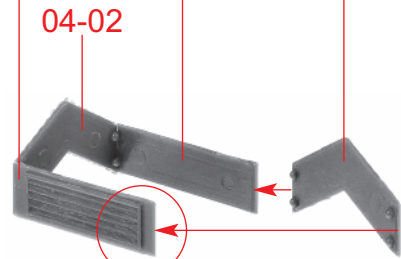
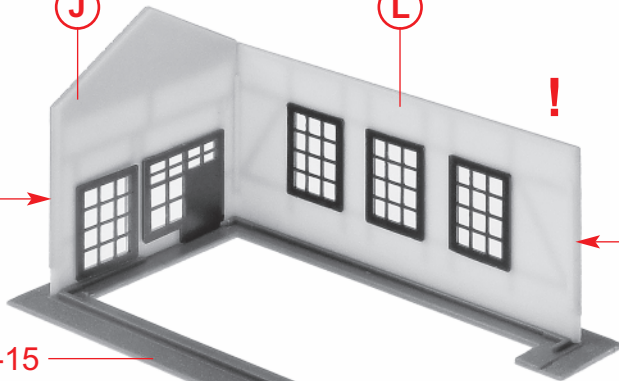
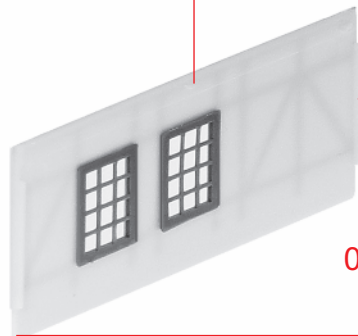

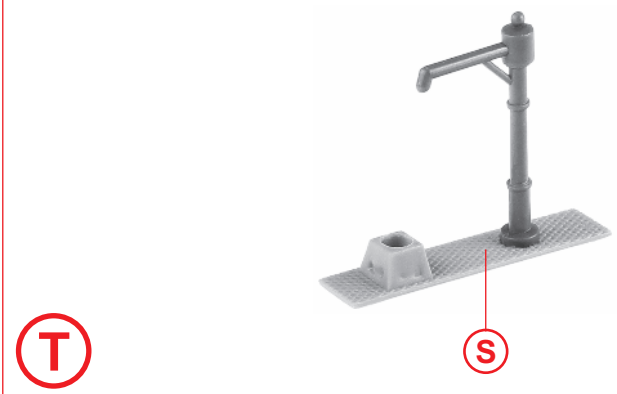
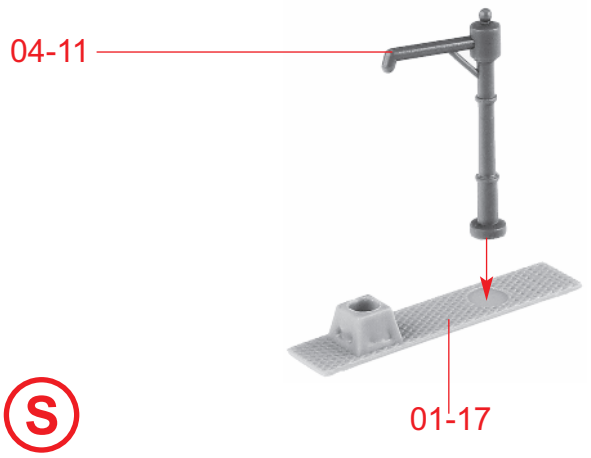
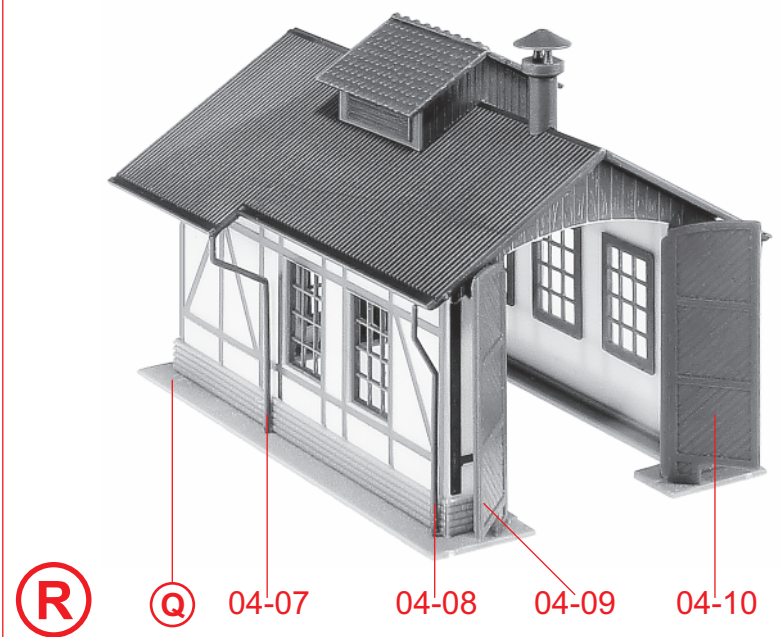
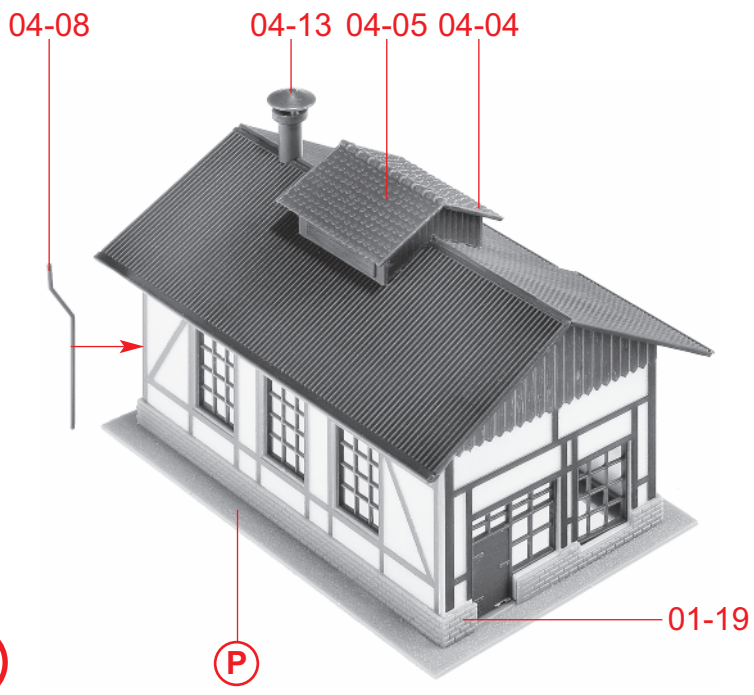

8

01-01

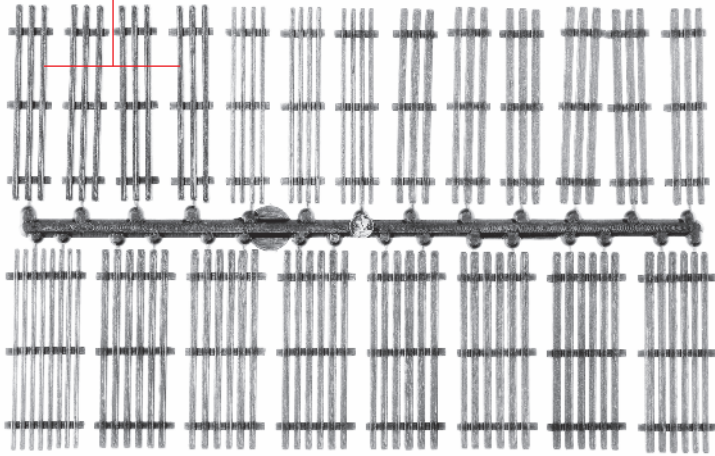

04

01-01

01-01

01-01

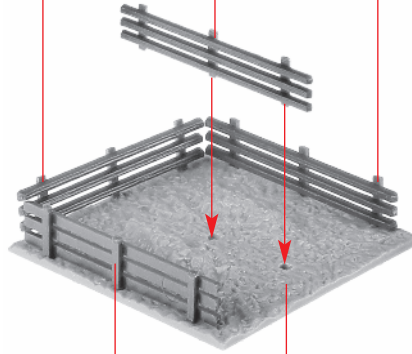

U

01-01

01-16

V

U

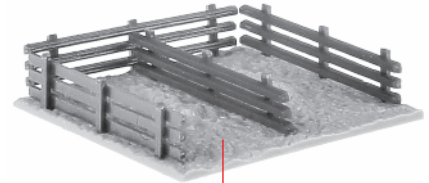

W

I

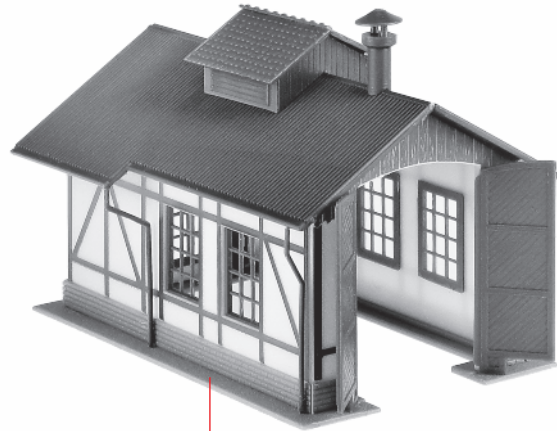

R



T



V