

GROSSER ALPENHOF MIT SCHEUNE

FALLER

LARGE ALPINE FARM WITH BARN

GRANDE FERME ALPINE AVEC GRANGE

GROTE ALPEN BOERDERIJ MET SCHUUR

Art. Nr. 232199

D

Vor Beginn des Bastelns sollten Sie sich mit den Spritzlingen und der Anleitung vertraut machen. Sollte es einmal vorkommen, dass ein Teil im Bausatz fehlt, kreuzen Sie bitte das fehlende Teil in der Anleitung an und schicken Sie diese bitte an Fa. Gebr. FALLER GmbH, Abt. Kundendienst, kundendienst@faller.de, Kreuzstraße 9, 78148 Gütenbach. Sie erhalten dann umgehend Ersatz. Es kann vorkommen, dass bei einem Bausatz Einzelteile übrig sind.

GB

Before beginning with the assembly please familiarize yourself with the parts and read the instructions carefully. In case of missing parts please indicate these on the instructions leaflet with a circle and return the leaflet to Gebr. FALLER GmbH, kundendienst@faller.de, Kreuzstraße 9, D-78148 Gütenbach, Germany. You will receive the replacement by return. It may happen in a kit that some parts are not required.

F

Avant de commencer le montage de votre maquette bien lire la notice et repérer les grappes. Si une pièce manque dans une boîte, cochez la pièce correspondante sur la notice et renvoyez-la-nous à Gebr. FALLER GmbH, kundendienst@faller.de, Kreuzstraße 9, D-78148 Gütenbach (R.F.A.). Nous vous ferons parvenir la pièce par retour. Dans certains kits, il est possible que certaines pièces ne soient pas utilisées.

NL

Vóór het bouwen zou men de gietstukken en de handleiding moeten bestuderen. Indien onverhoopt een onderdeel aan het bouwpakket ontbreekt, gelieve men het ontbrekende deel in de handleiding aan te kruisen en deze te zenden aan Gebr. FALLER GmbH, kundendienst@faller.de, Kreuzstraße 9, D-78148 Gütenbach. U ontvangt dan omgaand en gratis het ontbrekende onderdeel. Het kan voorkomen dat u bij bepaalde bouwdozen onderdelen overhoudt.

Für den Zusammenbau des Modells empfehlen wir folgende FALLER-Artikel (sind nicht im Bausatz enthalten):

For the assembly of the kit we recommend following FALLER products (not included in the kit):

Pour l'assemblage du modèle, nous vous recommandons les articles FALLER suivants (non inclus dans le kit):

Om dit model te bouwen adviseren wij de volgende FALLER producten (maken geen deel uit van deze bouwset):



Art. Nr. 170492
FALLER-EXPERT

Flüssigkleber in Plastikflasche mit Spezialkanüle für feinste Klebstoffdosierung.

Liquid cement in plastic bottle with canule for very fine dosage.

Cette liquide en bouteille plastique avec bec verseur pour un dosage précis.

Vloeibare lijm in plastic flescon met doseerbuisje om nauwkeurig te lijmen.



Art. Nr. 170688
SPEZIAL-SEITENSCHNEIDER

zum geriffelten Abtrennen von feinsten Spritzteilen.
Nur für Polystyrol geeignet.

Special side cutter for cutting off ultra-fine moulded parts without burrs. Only suitable for polystyrene.

Pince coupants spéciale pour couper sans bavure les pièces miniatures moulées par injection. Convient uniquement au polystyrène.

Speciale zijknijptang voor het braamloos afknippen van de fijnste gietstukdelen. Alleen geschikt voor polystyrol.



Sa. Nr. 232 199 1

2

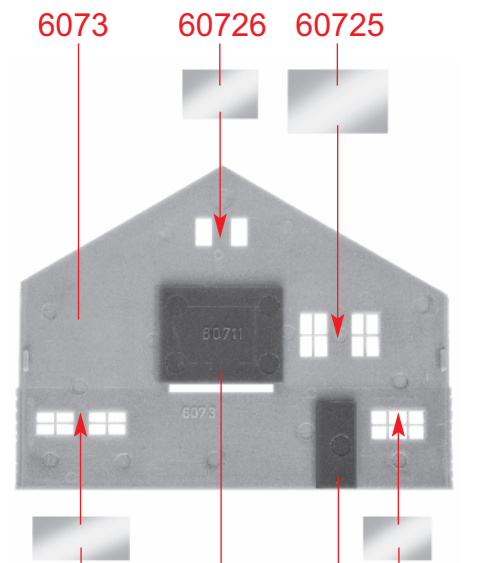

(A) 60723 60711 60739 60724

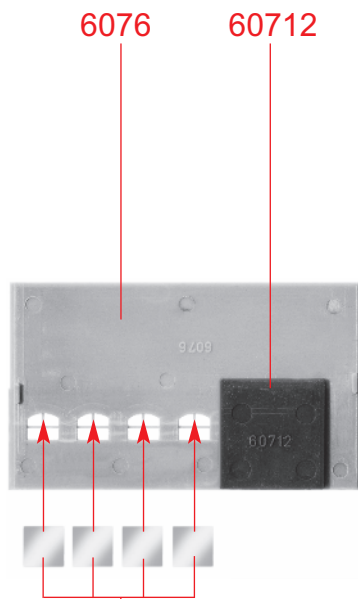

(C) 60722

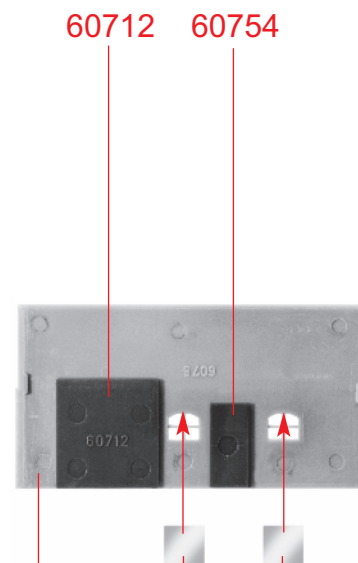

(E) 6075 60722

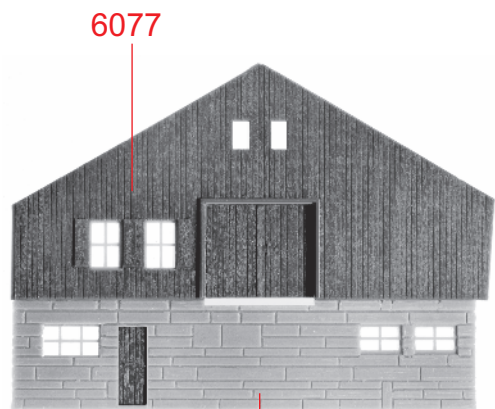

(B) **(A)**

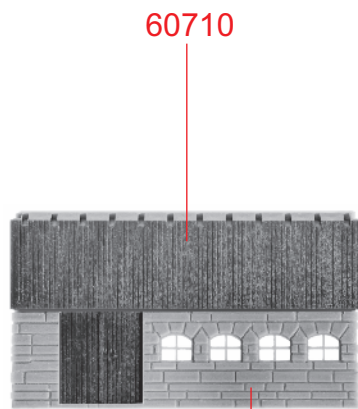

(D) **(C)**

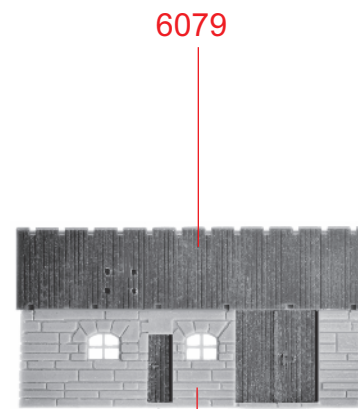

(F) **(E)**

60728 (6,5 mm)

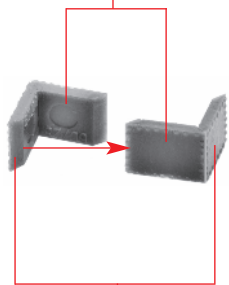

G 60728 (6 mm)

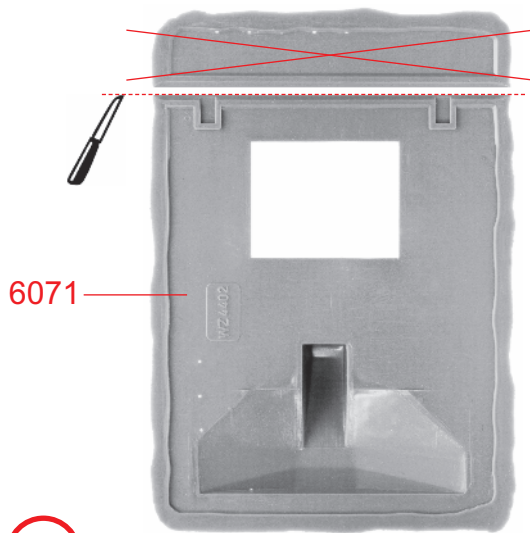

H

6074

D

F

B

3

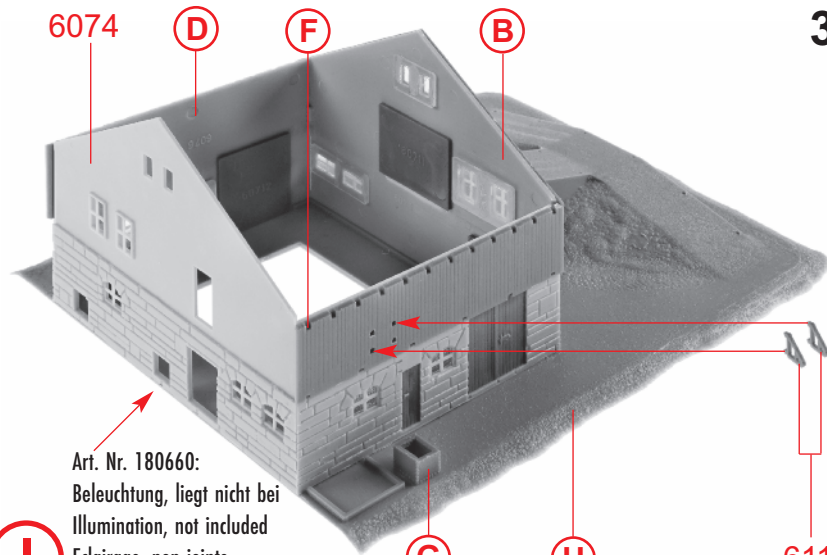

I

Art. Nr. 180660:
Beleuchtung, liegt nicht bei
Illumination, not included
Eclairage, non jointe
Verlichting, niet bijgevoegd

G

H

611

60740

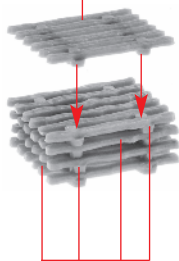

J 60740

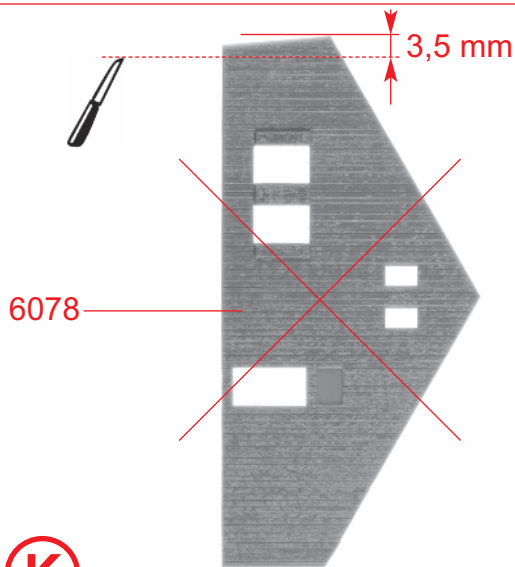

K

K

607

609

J

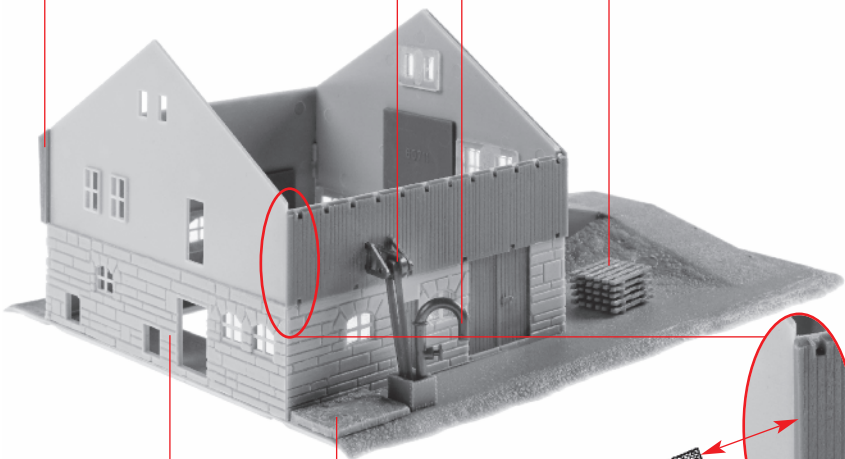

L

I

60736

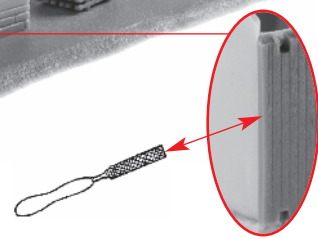

4

2 x 60716

60733

60731

Papiermaske
Papermask
Masque
Masker
Sa. 196 011 0

60714

60752

60745

60751

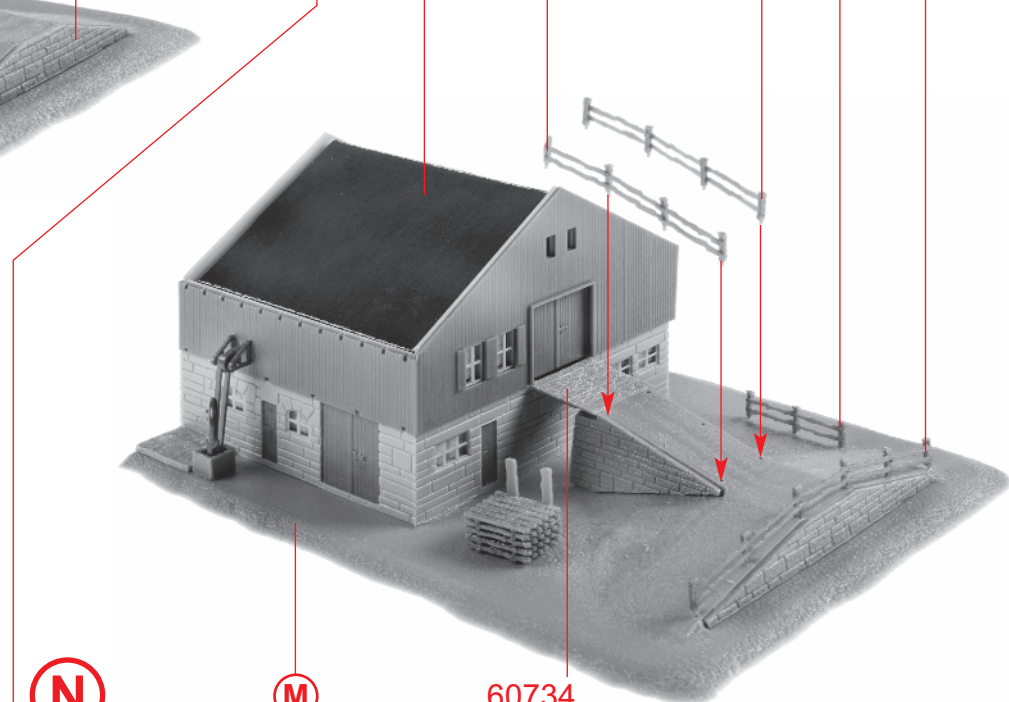
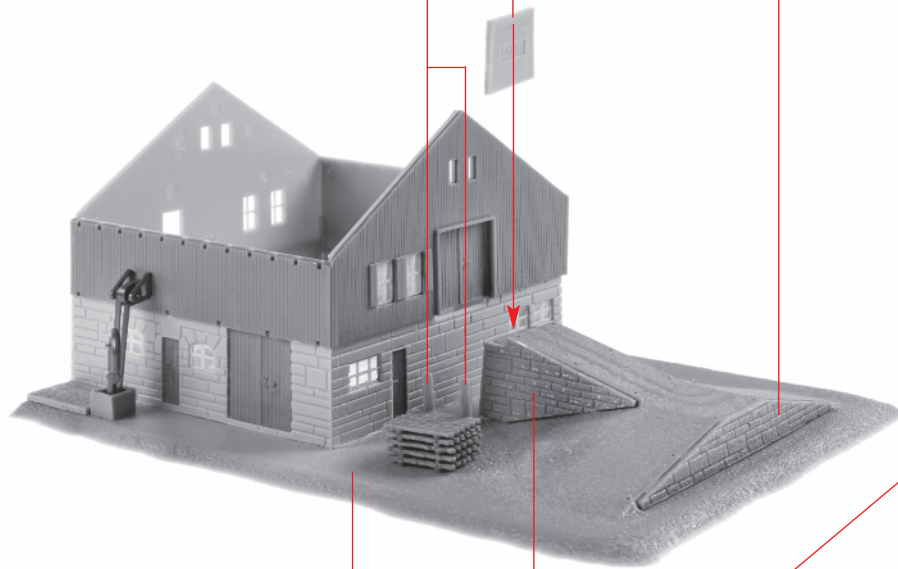

M

L

60732

N

M

60734

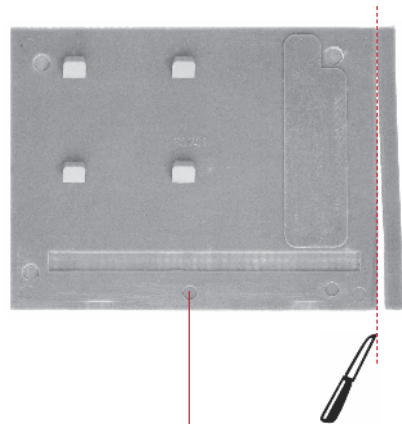

O

60721

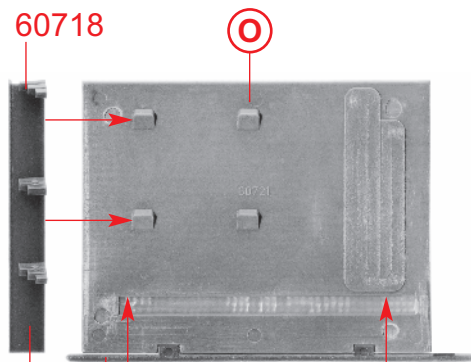

P

60717 60730



braun
brown
brun
bruin

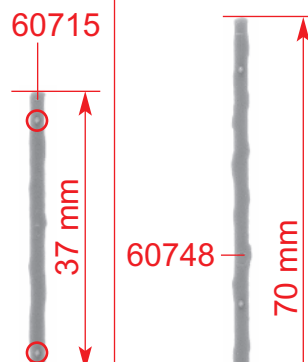

Q

6 x

7 x

R

60748

70 mm

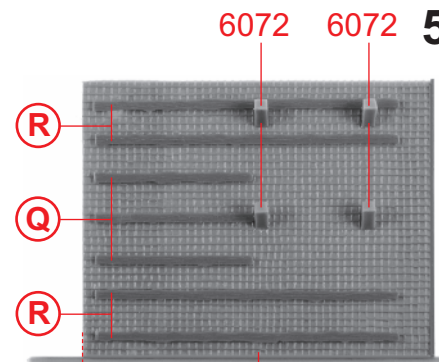

S

P

6072 6072 **5**

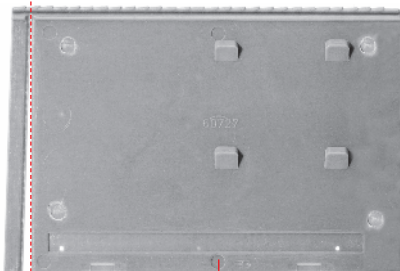

T

60727

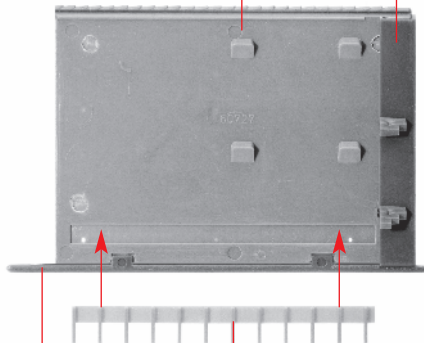

U

60717 60719

T

60738

braun
brown
brun
bruin

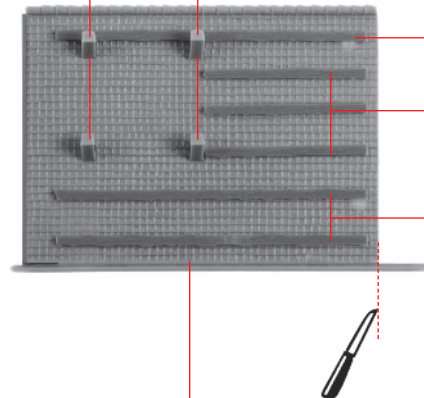

V

U

6072 6072

R

Q

R

6

S

V

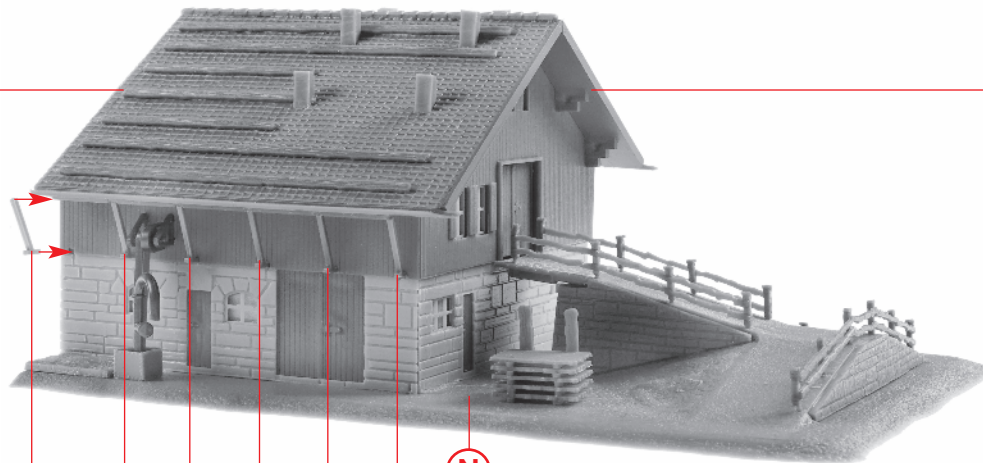

60720

N

W

60741

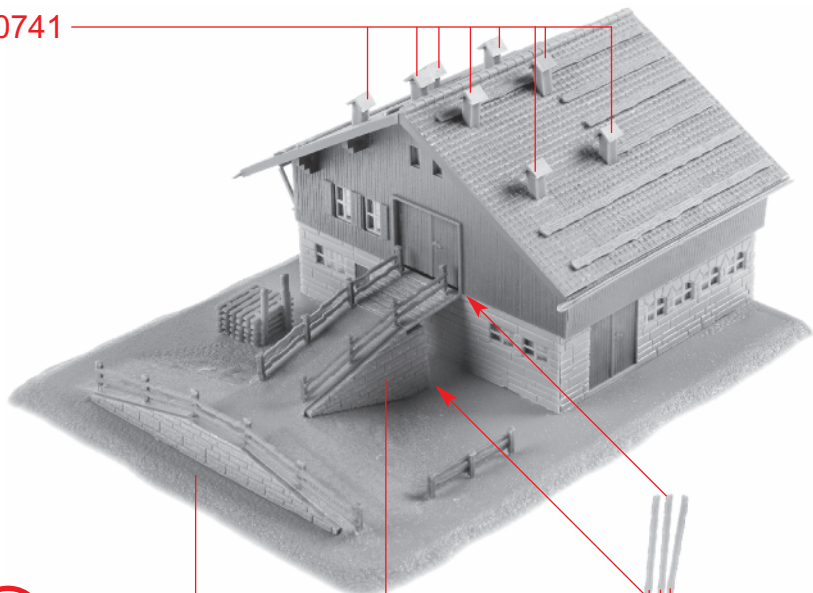

W

60735

60747

X

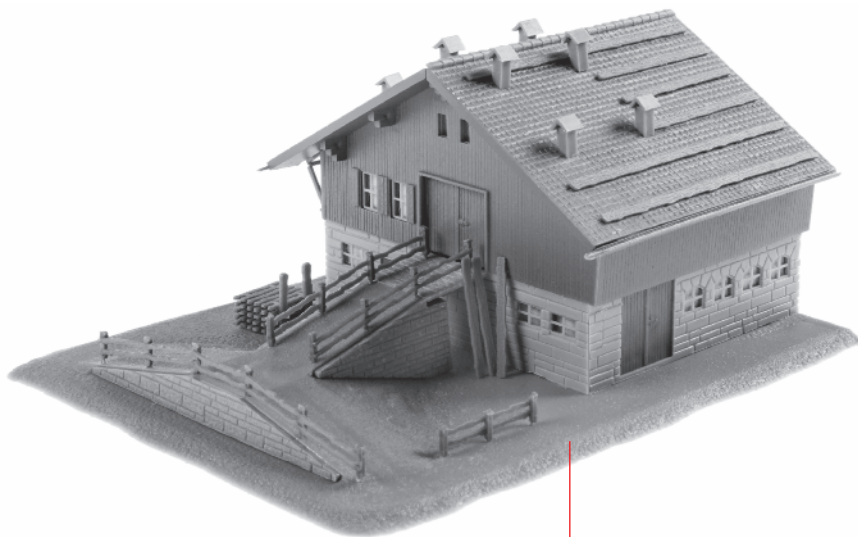

Y

X

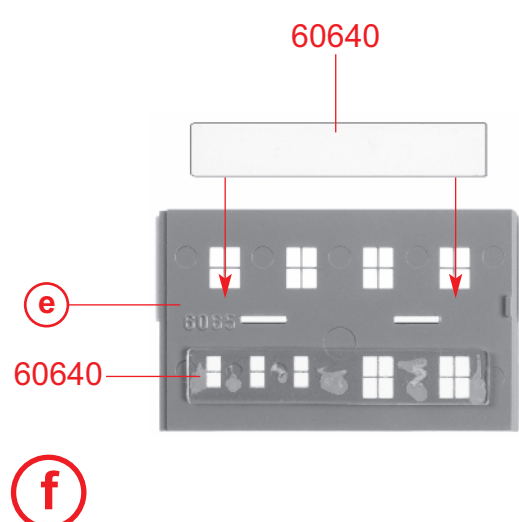
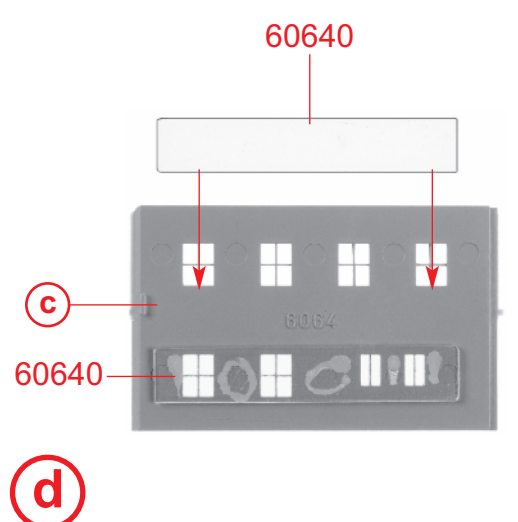
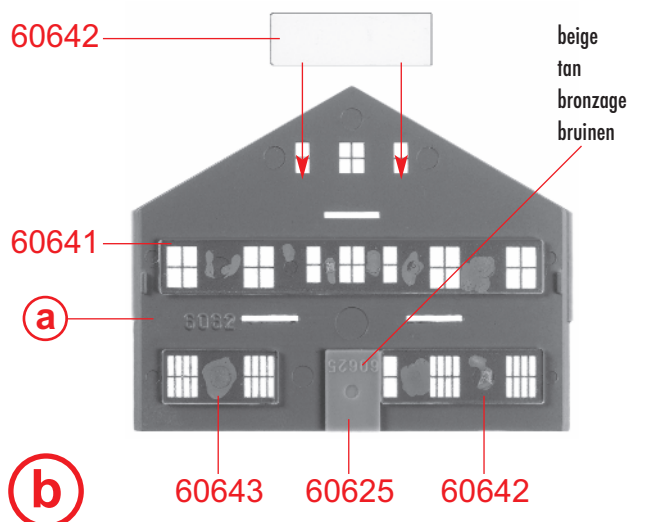
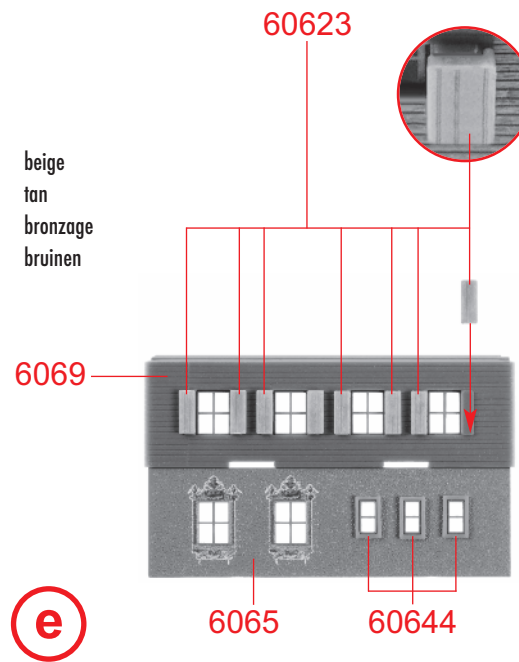
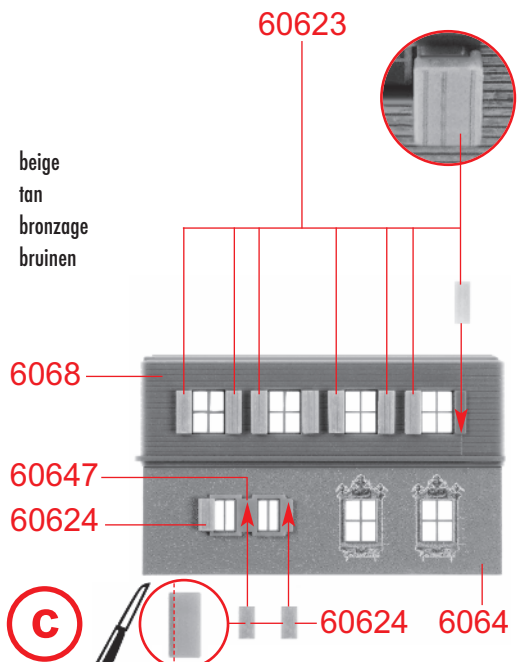
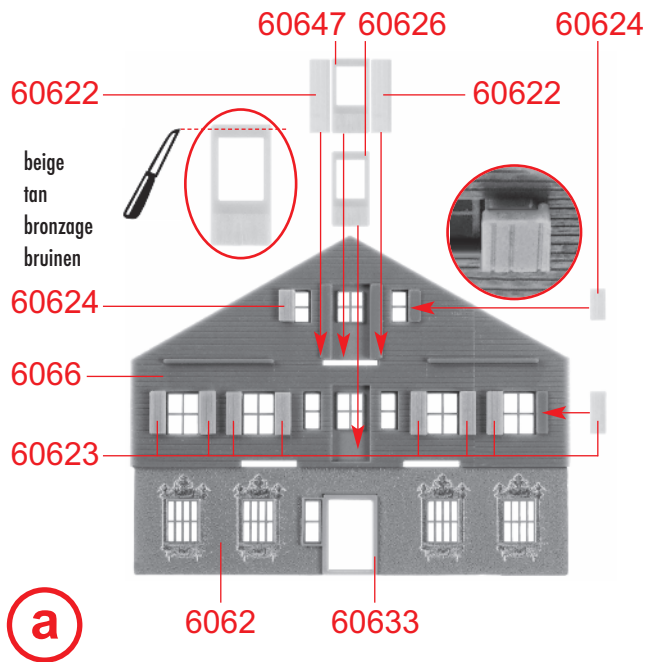

8

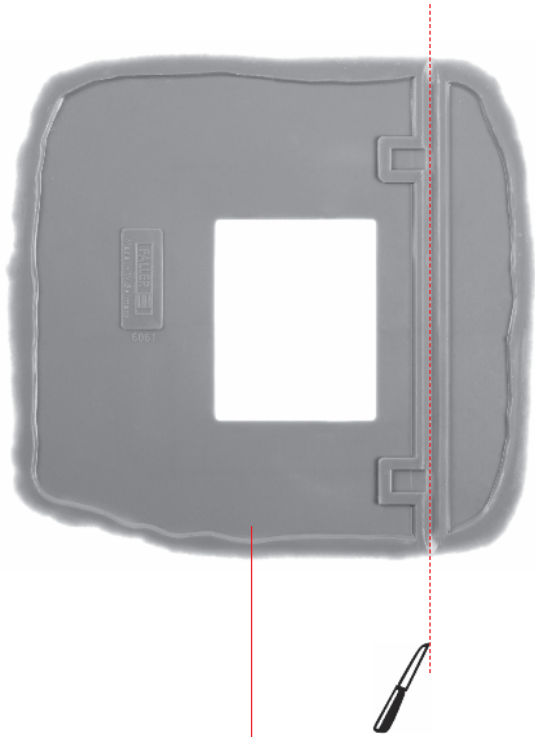

6061

g

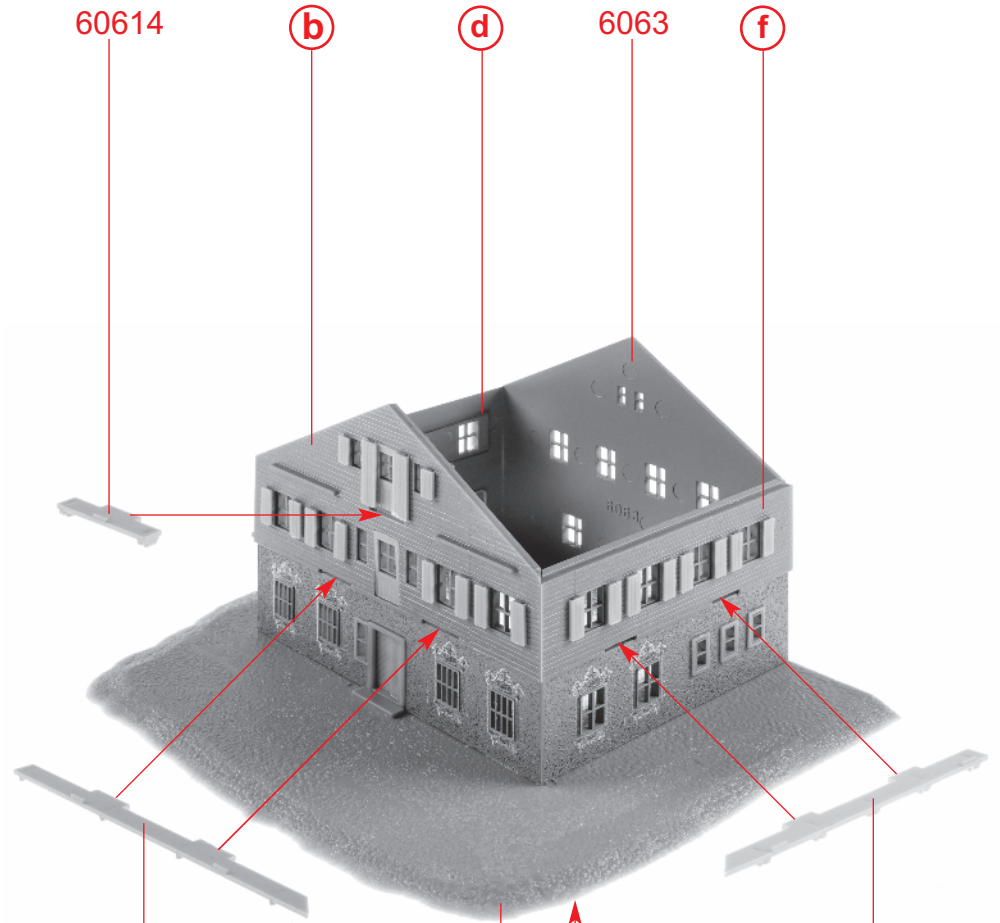

60614

b

d

6063

f

60610

h

g

60612

Art. Nr. 180660:
Beleuchtung, liegt nicht bei
Illumination, not included
Eclairage, non jointe
Verlichting, niet bijgevoegd

60613

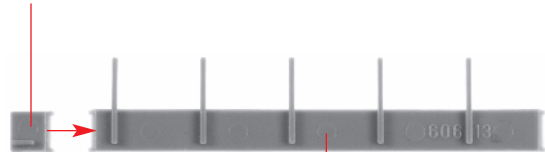

i

60613

60615

60615

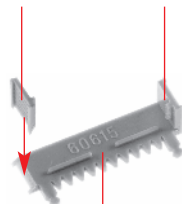

60615

j

60611

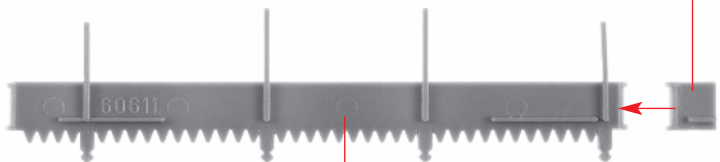

60611

k

j

Papiermaske
Papermask
Masque
Masker
Masker
Sa. 199 320 0

i

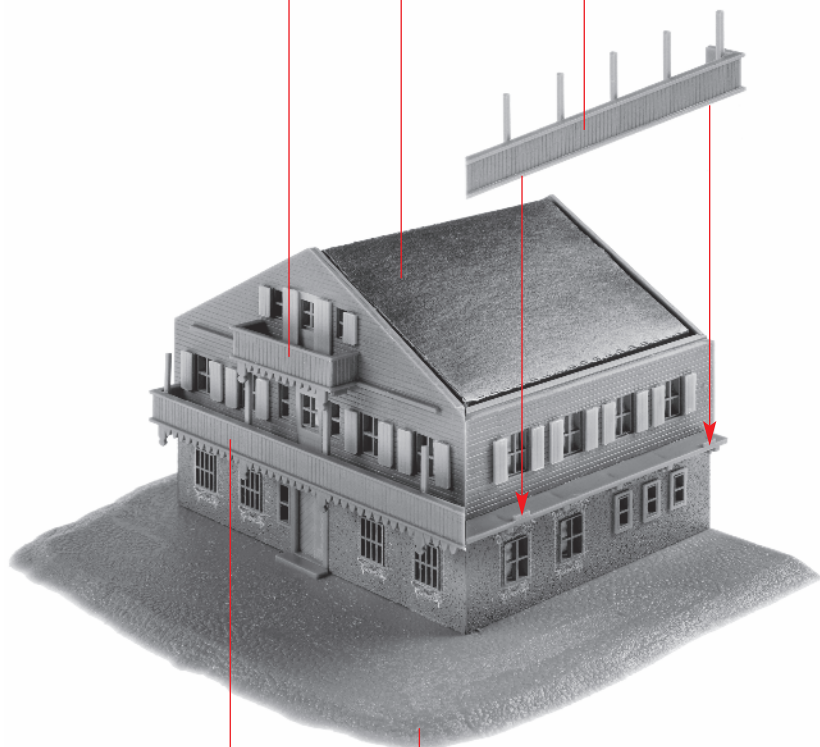

l

k

h

10

60620

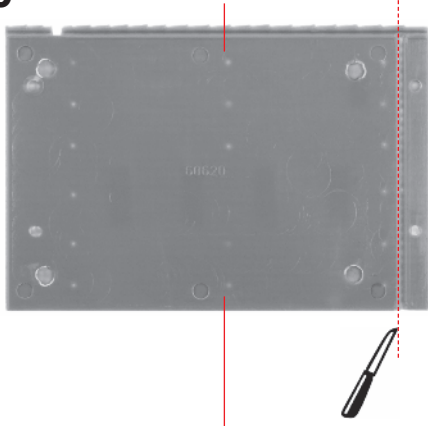

60621

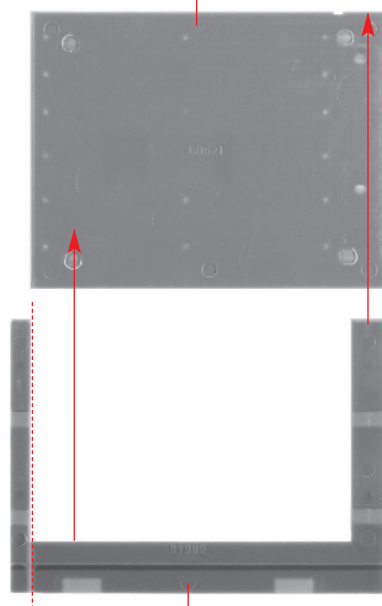
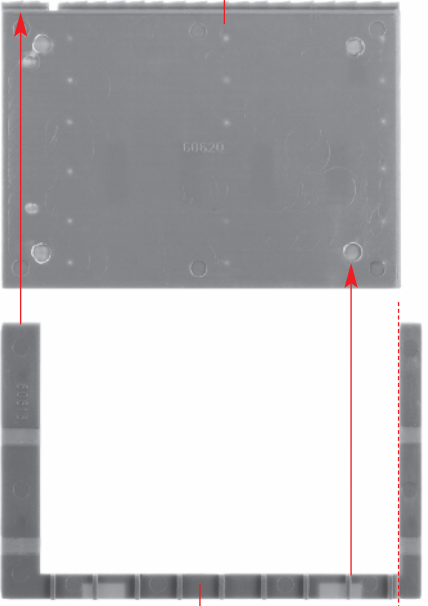
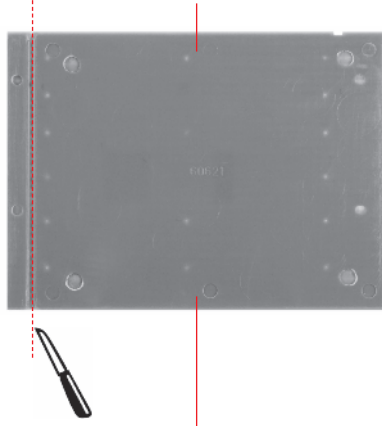

m

60616



n

60648



n

m

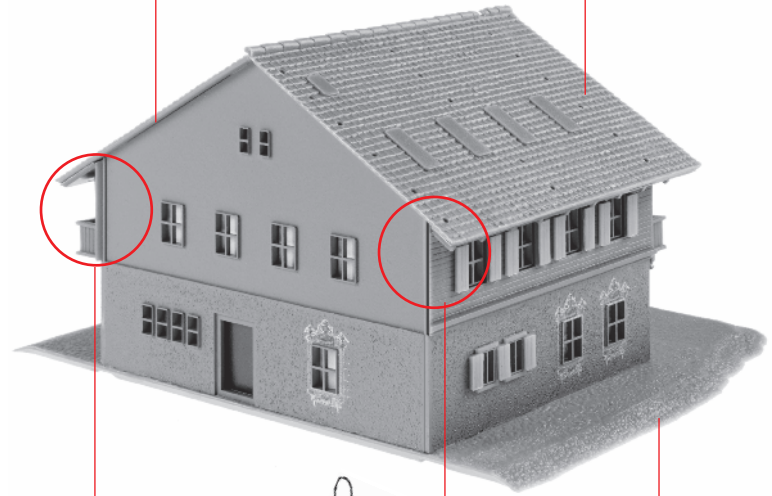

o

l

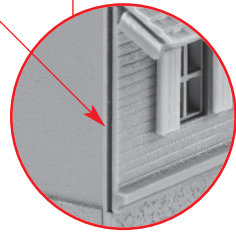
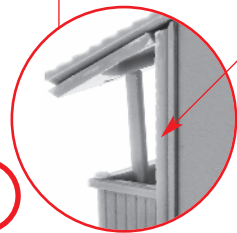

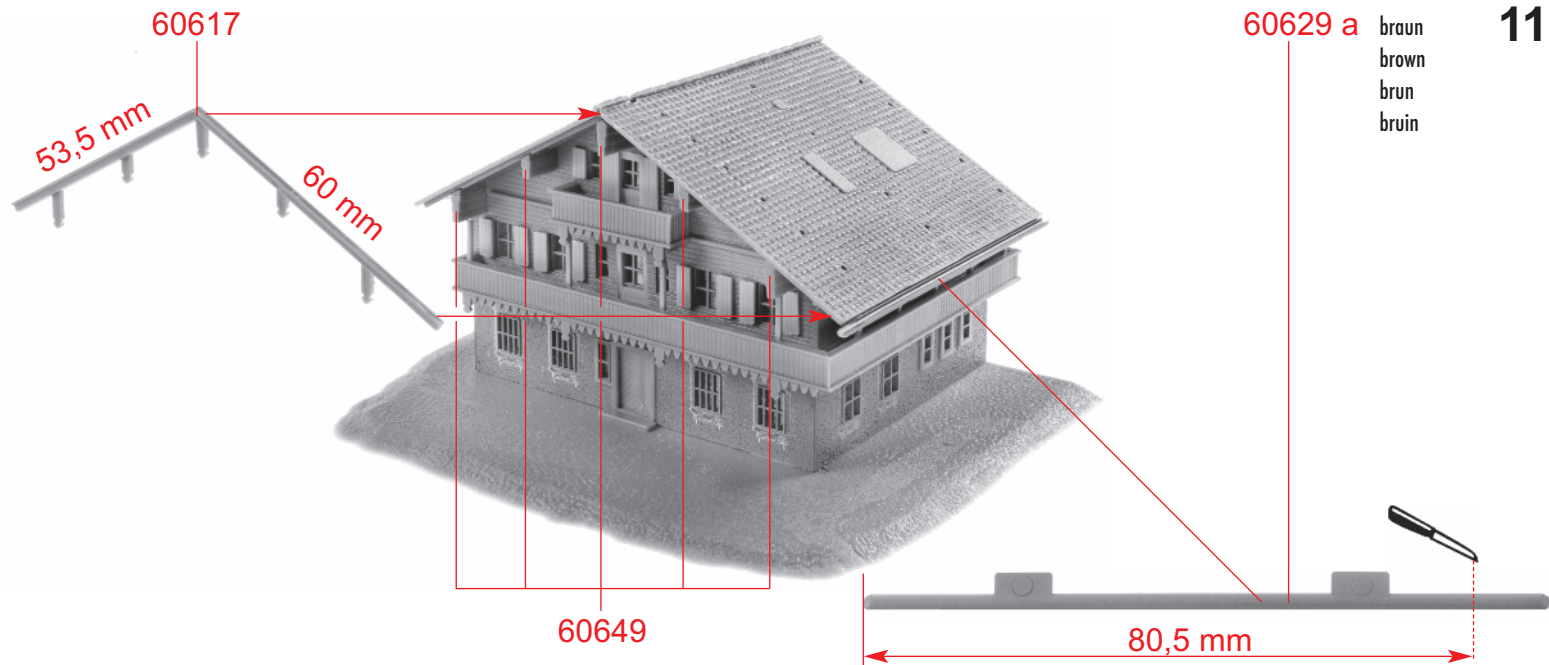

p

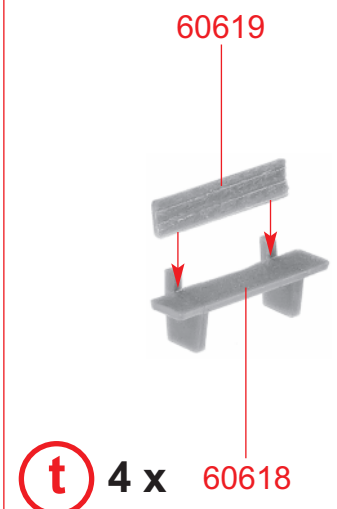
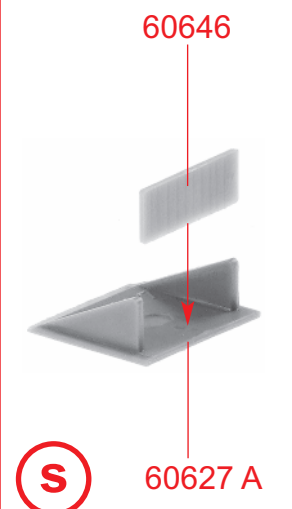
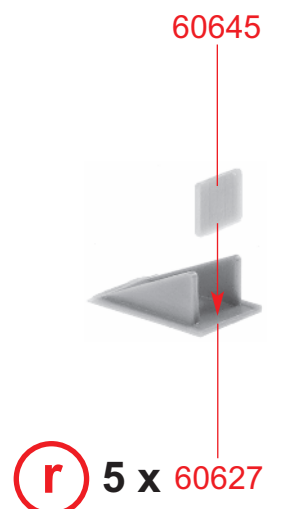
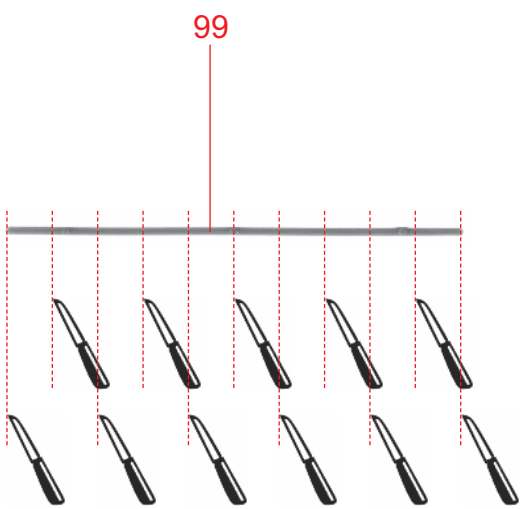

12

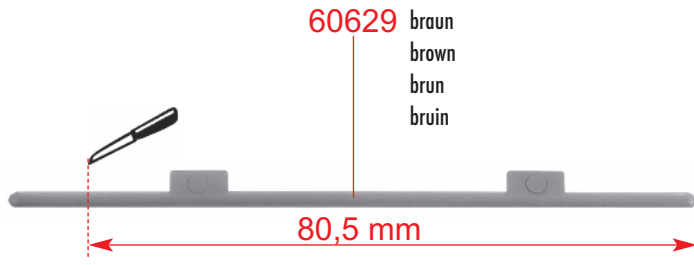

U

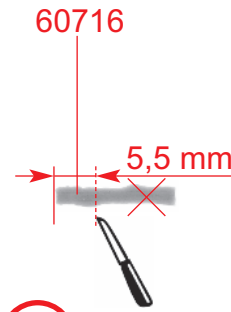

V

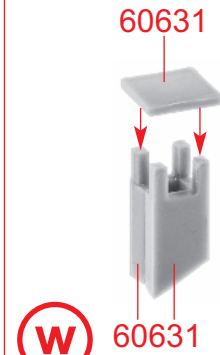

W

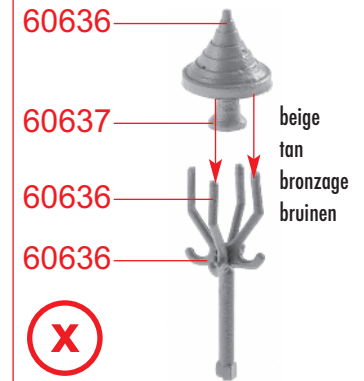

X

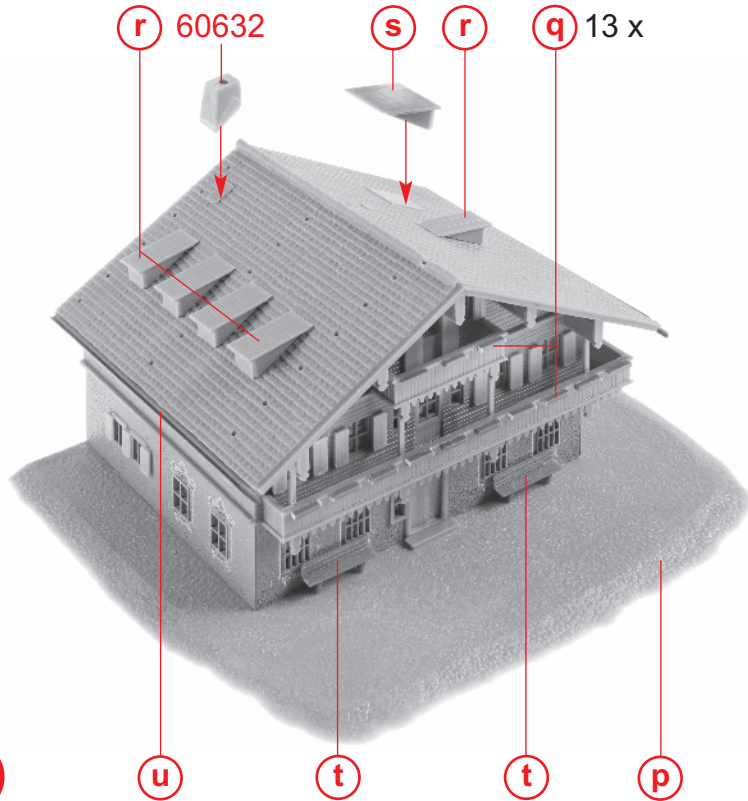

Y

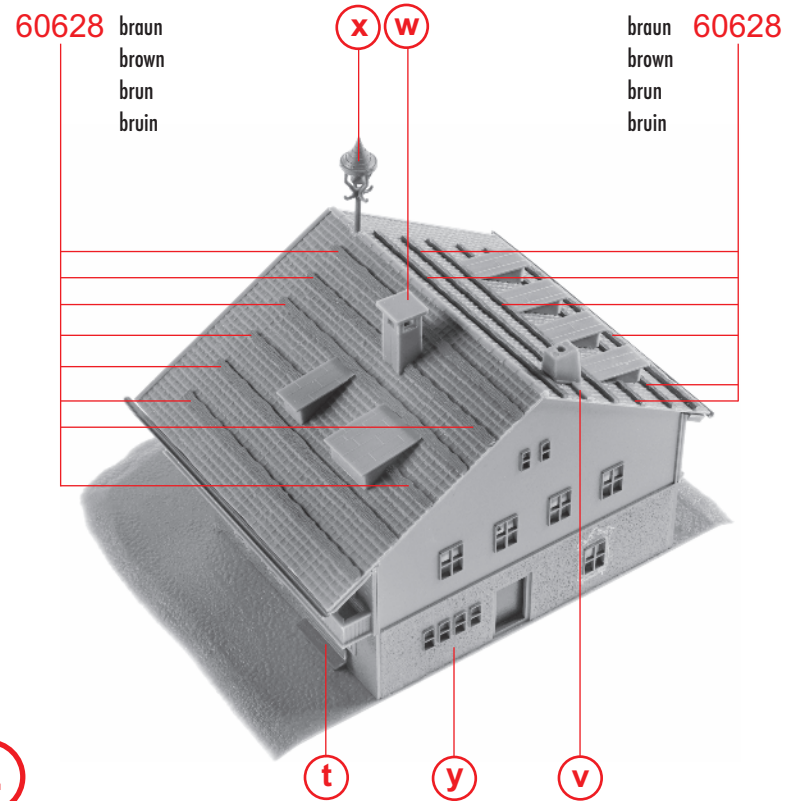

Z

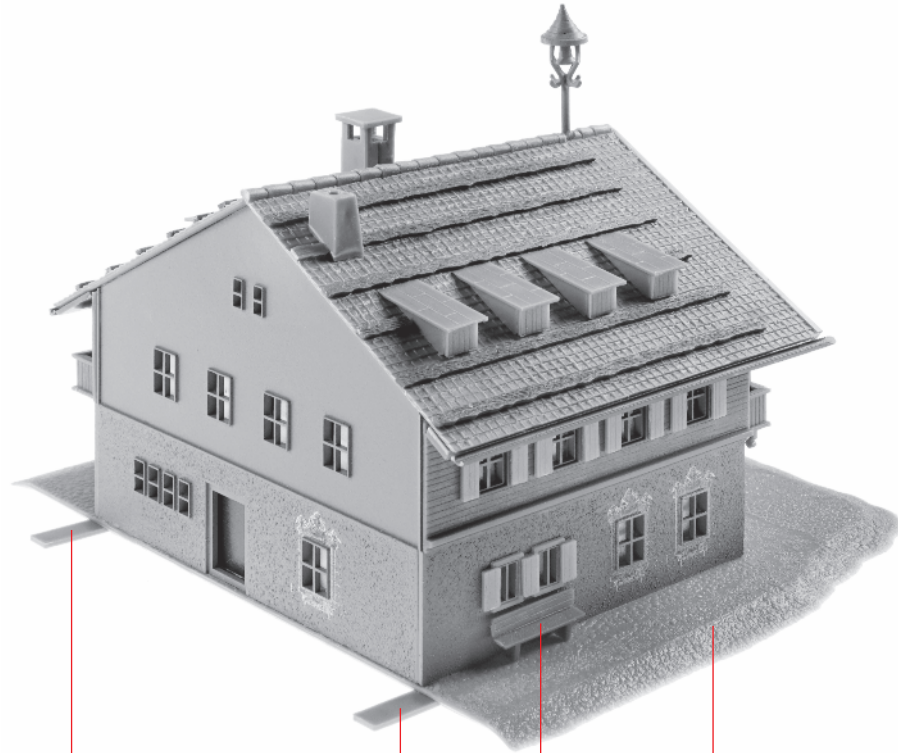

A

6061 A

6061 A

t

z

14

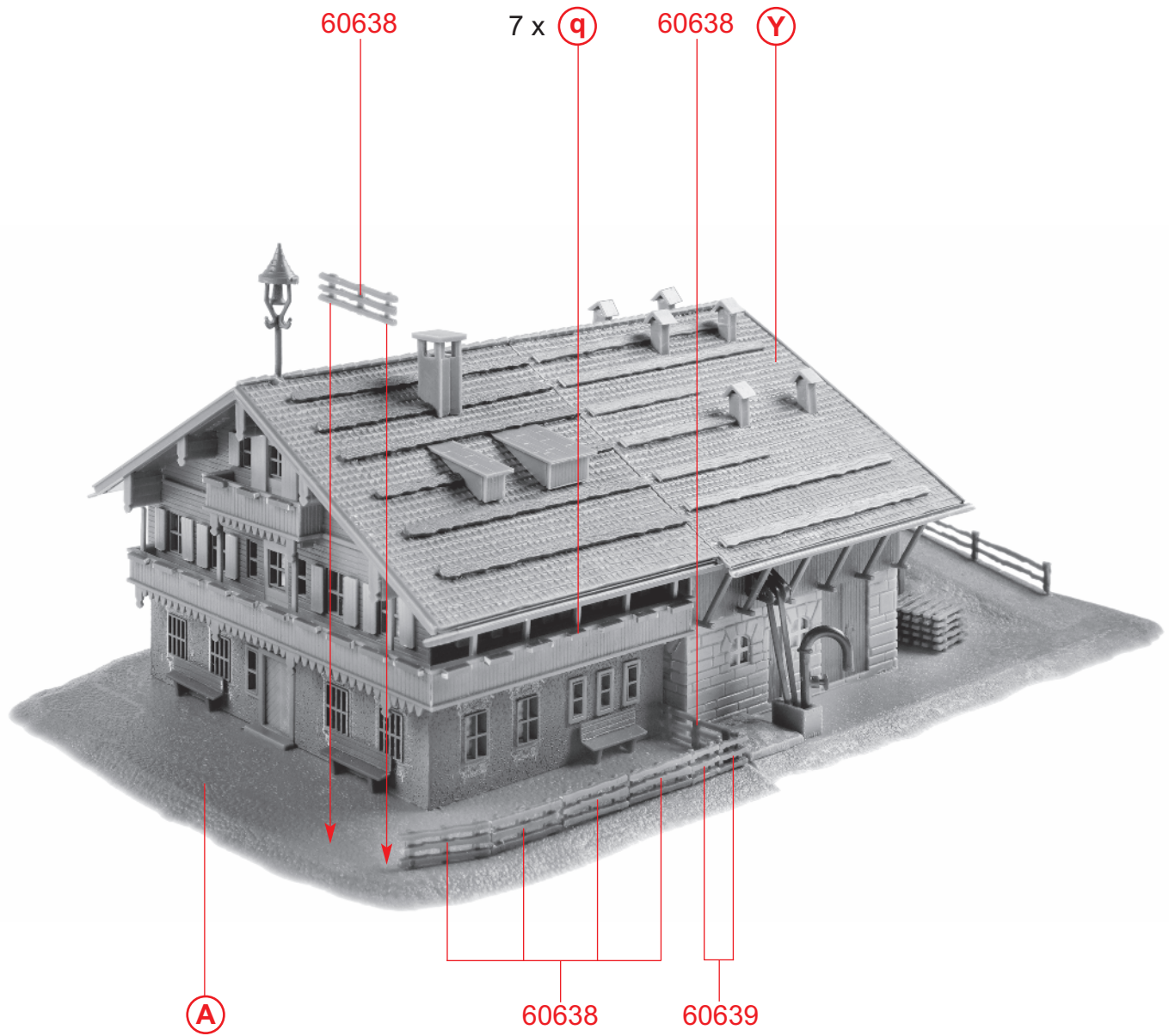

(B)

(A)

7 x q

60638

(Y)

60638

60639

Inhalt	Tüte	Contents	bag
Contenu	sachet	Inhoud	zakje

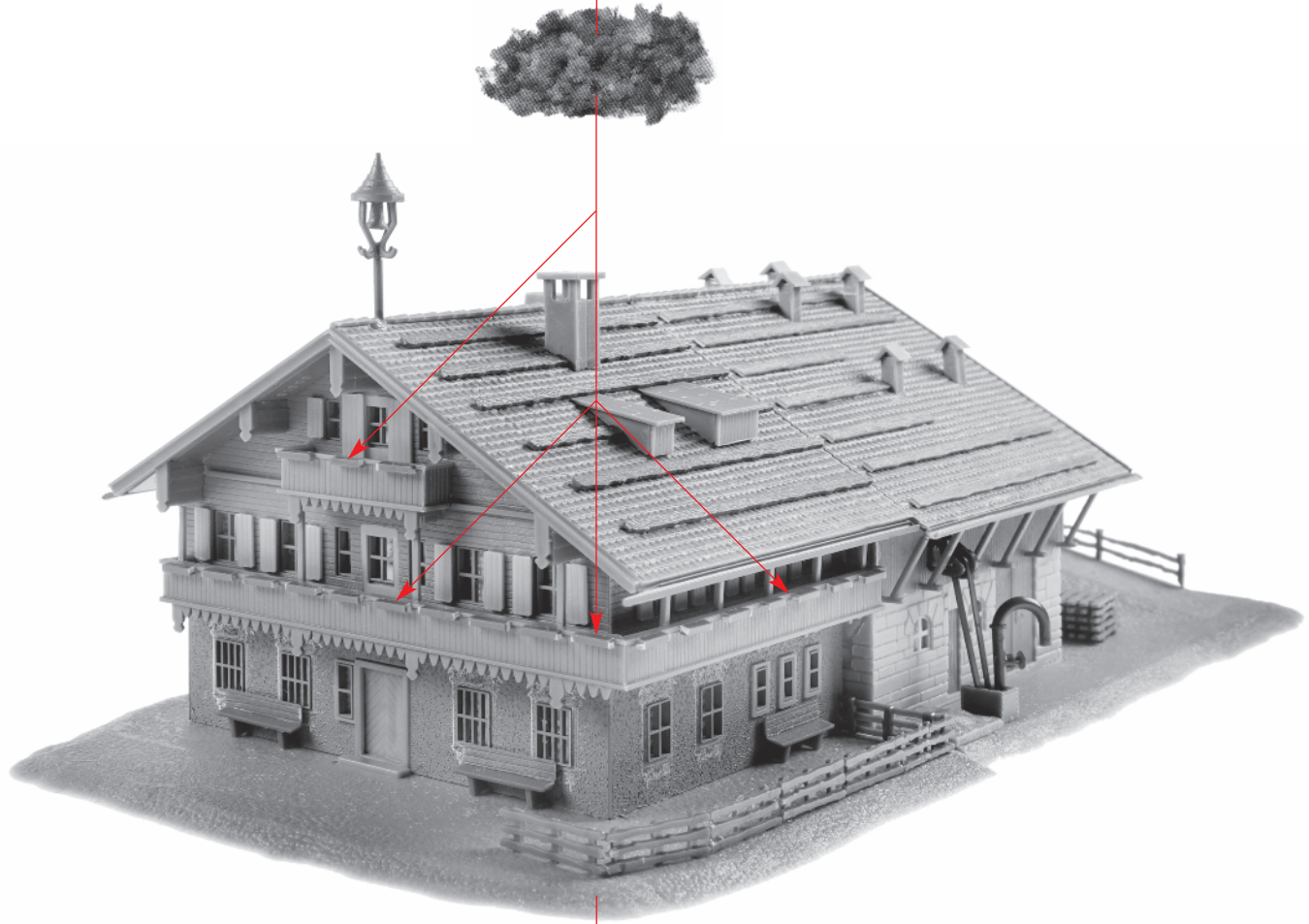

©

B

16

Inhalt	Tüte	Contents	bag
Contenu	sachet	Inhoud	zakje

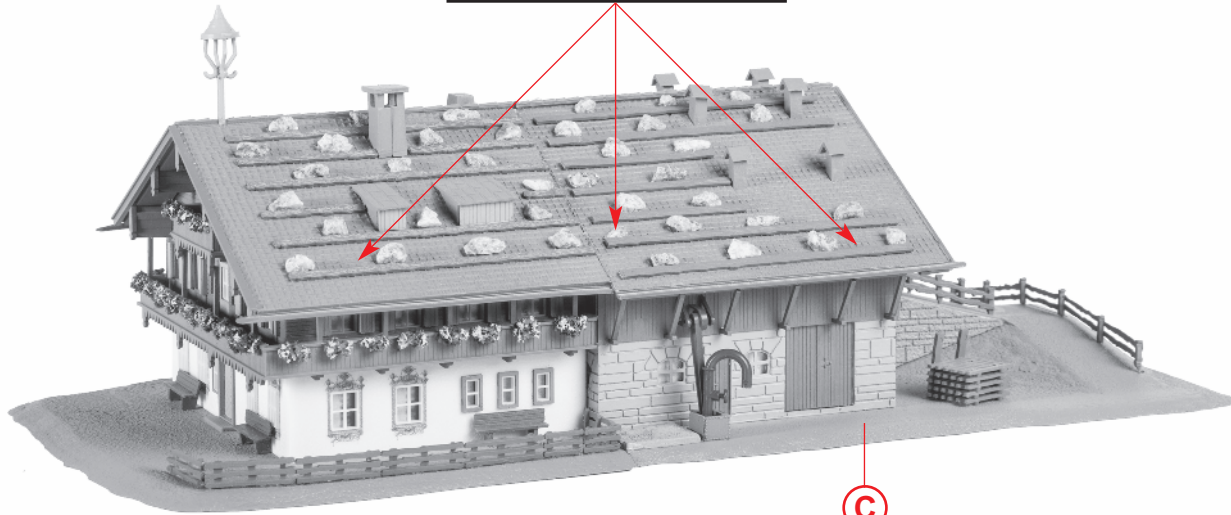

D

C

Inhalt	Tüte	Contents	bag
Contenu	sachet	Inhoud	zakje

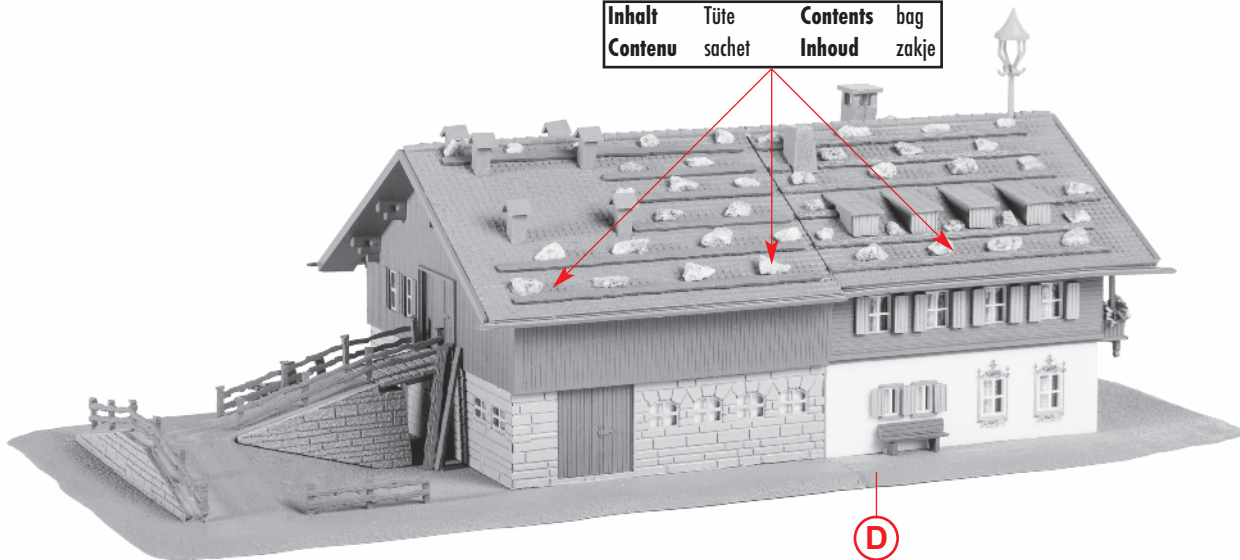

E

D