

# Ferienhaus

Holiday home  
Maison de vacances  
Vakantiehuisje

# POLA G

Art. Nr. 331093

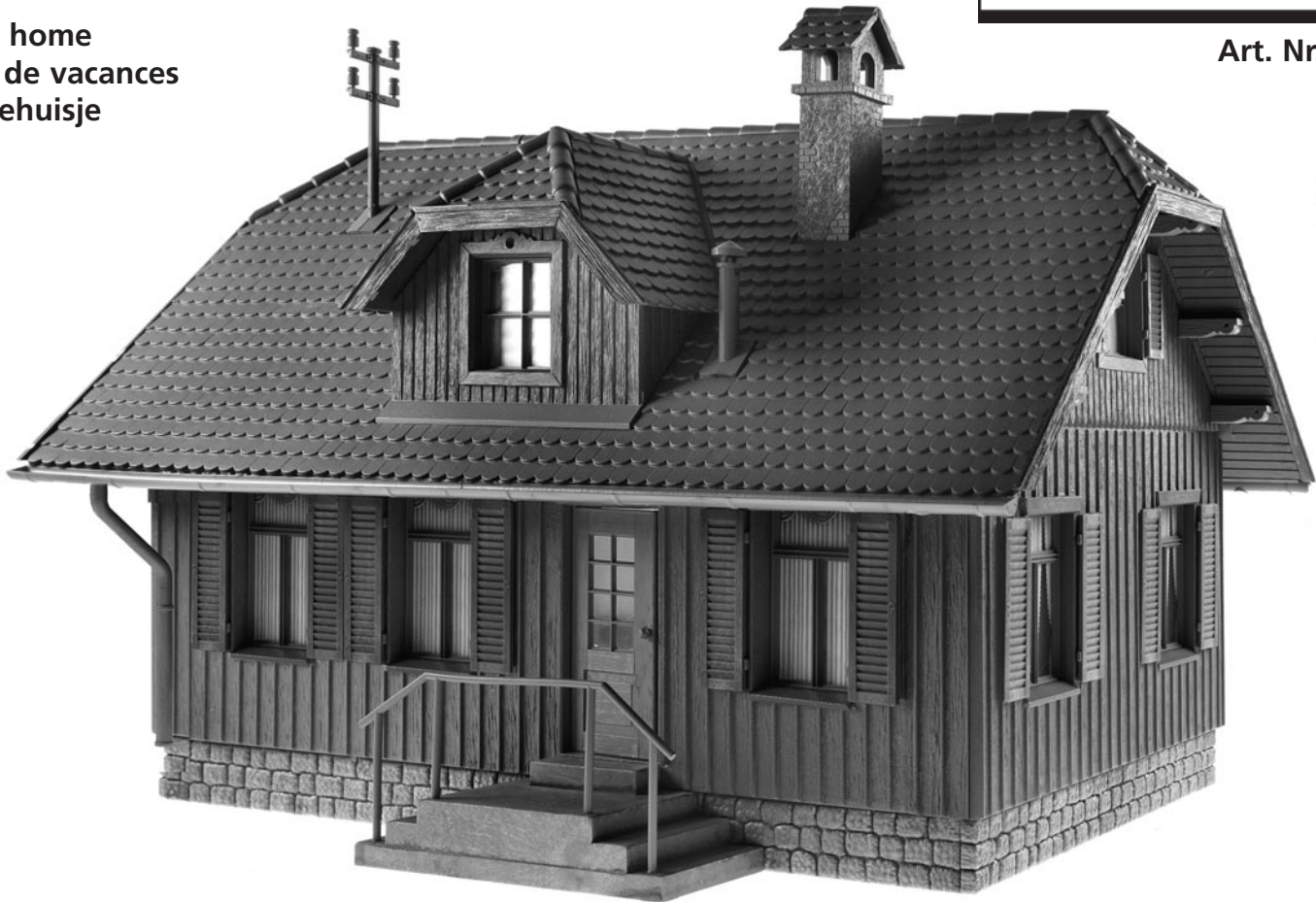

Sa. Nr. 331 093 1

**(D)** Verwenden Sie nur POLA G-Cement.  
Machen Sie sich bitte vor Beginn des Bastelns mit dem Bausatzinhalt und der Anleitung vertraut und prüfen Sie die Vollständigkeit. Im Reklamationsfall gilt die gesetzliche Gewährleistungspflicht.  
Sollte ein Teil fehlen, übersenden Sie bitte den Teilwunsch und den Kaufbeleg an:  
Gebr. FALLER GmbH, Kundendienst, Kreuzstraße 9, D-78148 Gütenbach, kundendienst@faller.de.  
Sollten Sie einmal weitere Ersatzteile benötigen, senden wir Ihnen den benötigten Spritzling, bei Verfügbarkeit, gerne kostenpflichtig zu.  
Bitte beachten Sie, dass produktionsbedingt Einzelteile übrig bleiben können.

**(GB)** Use POLA G-Cement only.  
Before building your model, please familiarize yourself with the contents of the kit and the instructions for use, also checking whether the set of parts is complete. In case of any complaint, the legal guarantee obligation shall apply. Should a part be missing, please send the designation of the part required and the receipt documenting your purchase to: Gebr. FALLER GmbH, Kundendienst, Kreuzstraße 9, D-78148 Gütenbach, kundendienst@faller.de. Should you require further spare parts one day, we shall be pleased to send you, with costs, the required sprue, if it is available. Please note that, on grounds of the production process, some single injection molded parts may be superfluous.

**(F)** N'utilisez que la colle POLA G -Cement.  
Avant de commencer votre modèle, veuillez vous familiariser avec le contenu du kit et la notice d'emploi, et contrôlez que le lot de pièces est complet. En cas de réclamation, il s'appliquera l'obligation de garantie légale. Au cas où une pièce manquerait, veuillez envoyer la désignation de la pièce souhaitée et le bon d'achat à: Gebr. FALLER GmbH, Kundendienst, Kreuzstraße 9, D-78148 Gütenbach, kundendienst@faller.de. Au cas où vous auriez besoin un jour d'autres pièces détachées, nous vous enverrons volontiers la grappe requise, si elle est disponible, contre paiement.  
Veuillez noter que, pour des raisons de production, il se peut que des pièces détachées soient superflues.

**(NL)** Gebruik uitsluitend POLA G -cement.  
Maak uzelf vóór het bouwen vertrouwd met de inhoud van het bouw pakket en met de handleiding en controleer de volledigheid. In geval van reclamatie geldt de wettelijke garantieverplichting. Mocht er een onderdeel ontbreken, stuur het verzoek om het gewenste onderdeel en het aankoopbewijs dan naar: Gebr. FALLER GmbH, klantenservice, Kreuzstraße 9, D-78148 Gütenbach, kundendienst@faller.de. Als u ooit meer reserveonderdelen nodig hebt, sturen wij het benodigde gietstuk, indien beschikbaar, graag tegen betaling naar u op.  
Let op: om productieredenen kunnen losse onderdelen overblijven.



2

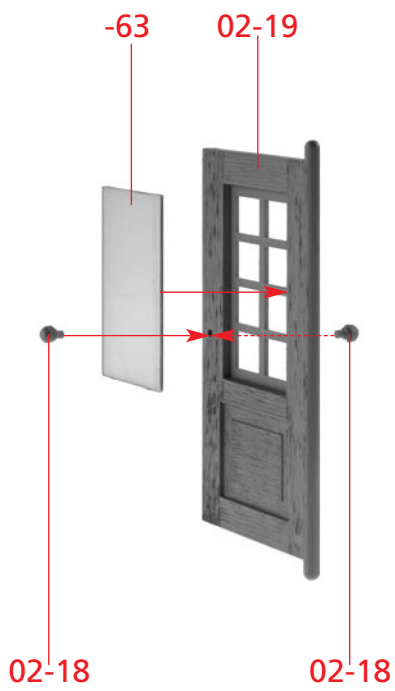

**(A)** 2 x

Deco

-61

-16

-6

**(B)** 2 x

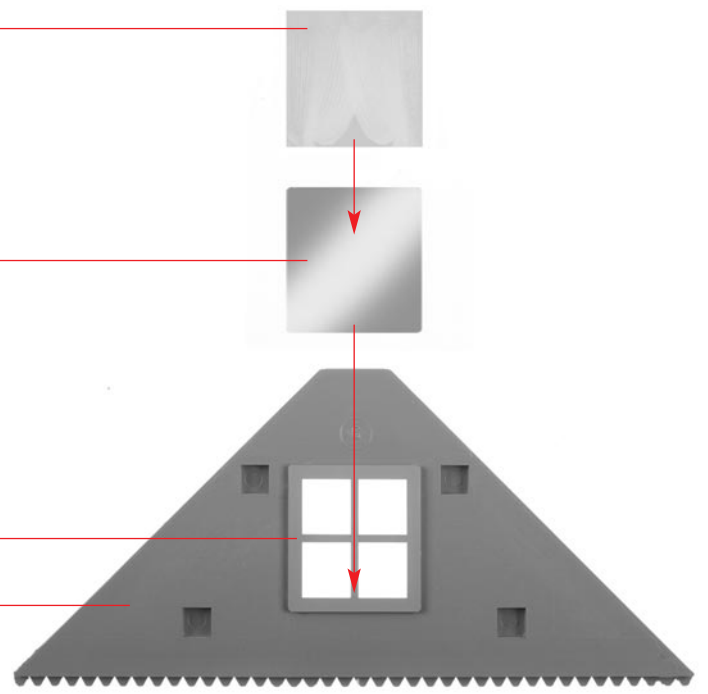

Deco

-60

nicht kleben  
do not glue  
ne pas coller  
niet lijmen

**(A)** 02-16

**(C)** 2 x

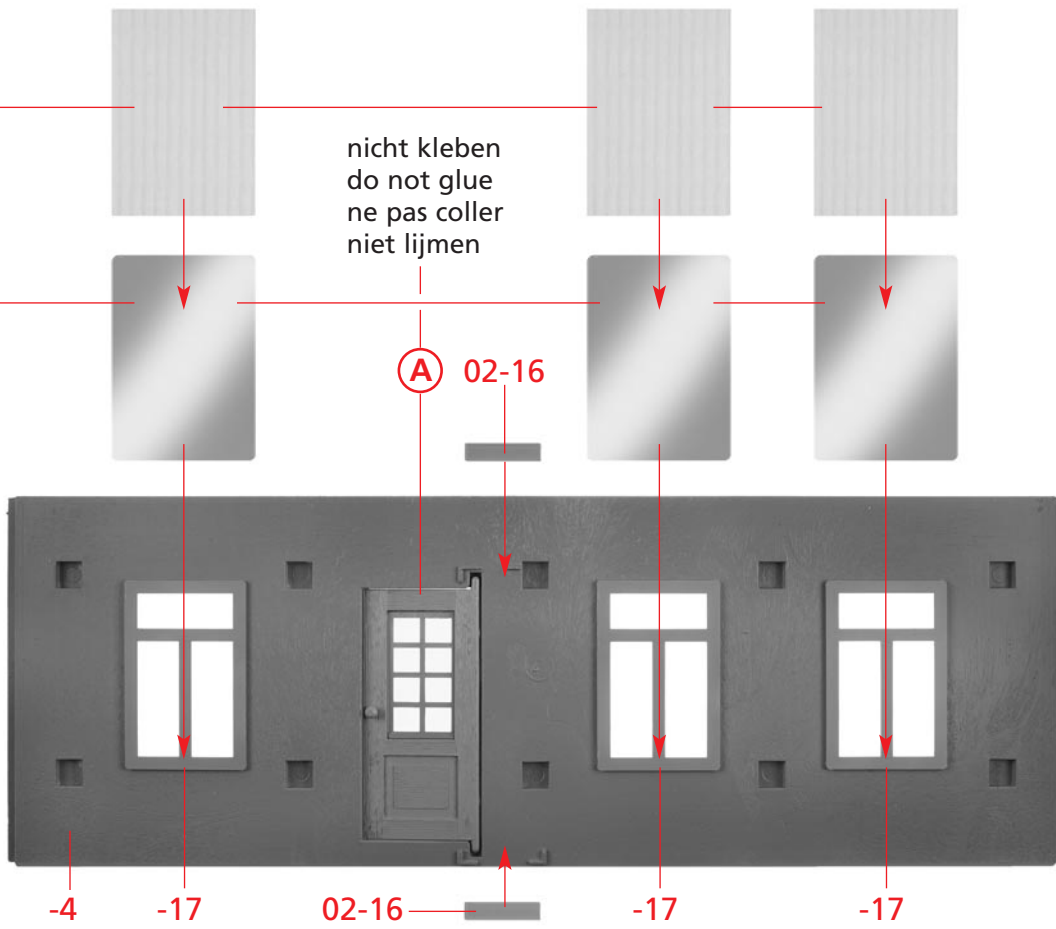

**(C)**



**(D)** 2 x

01-12

01-13

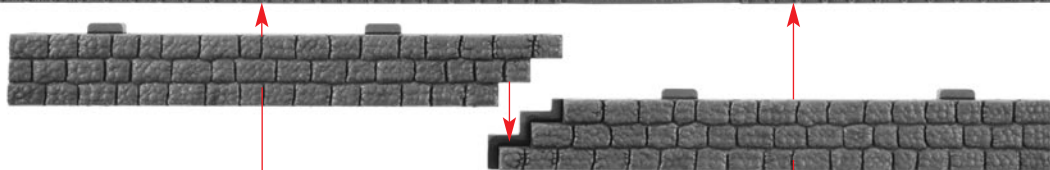

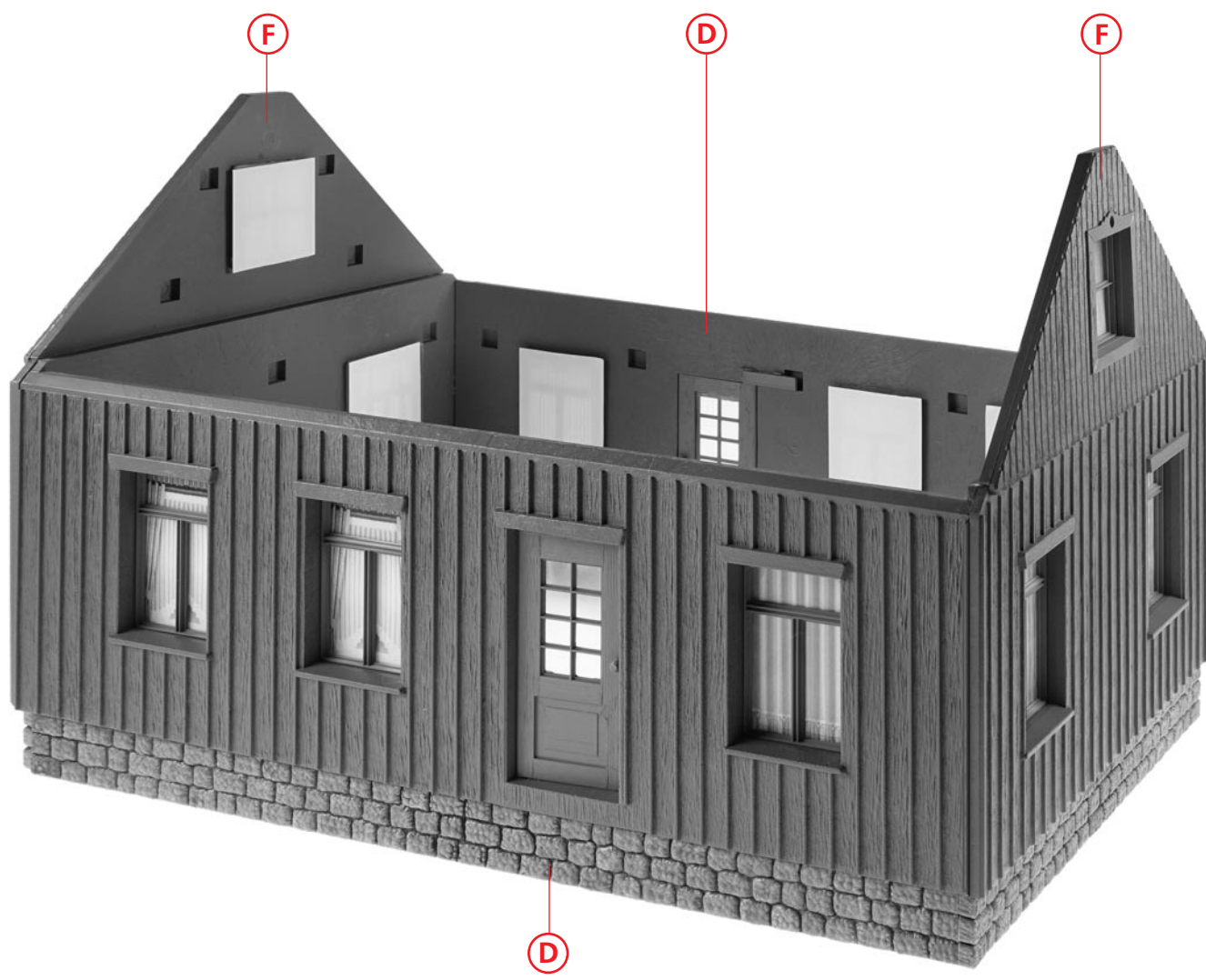
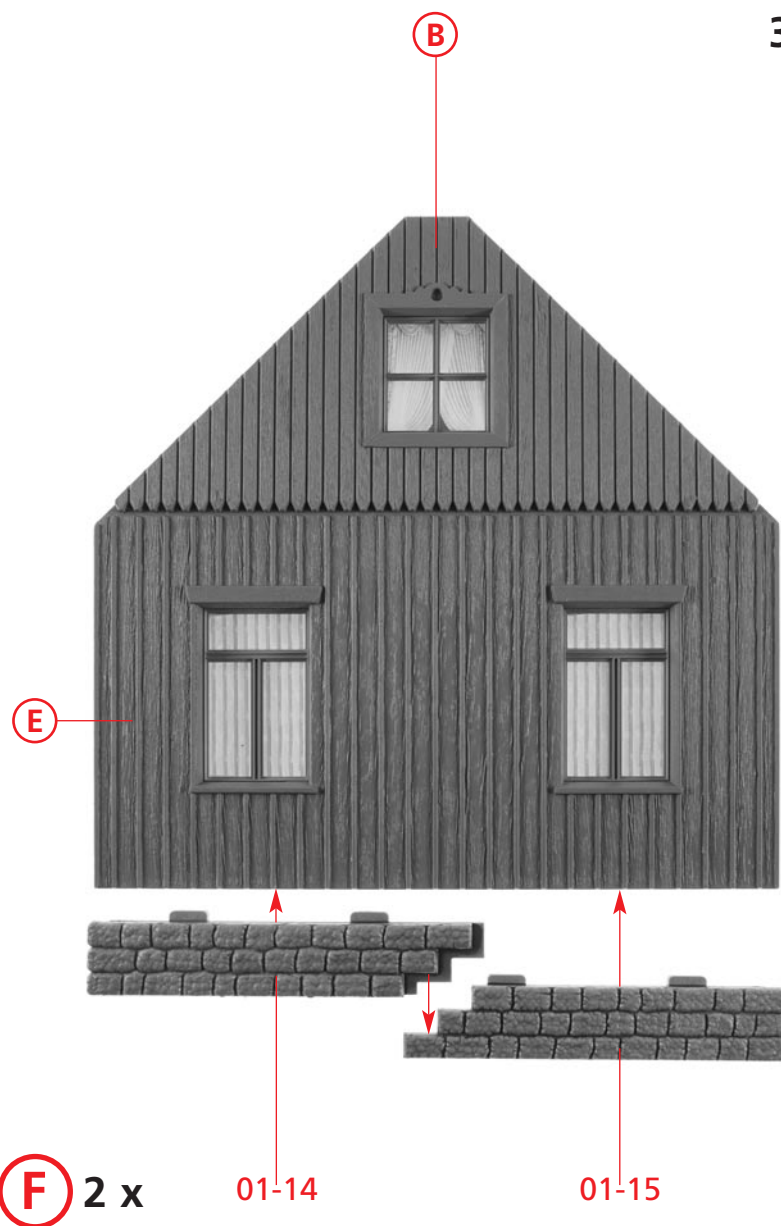
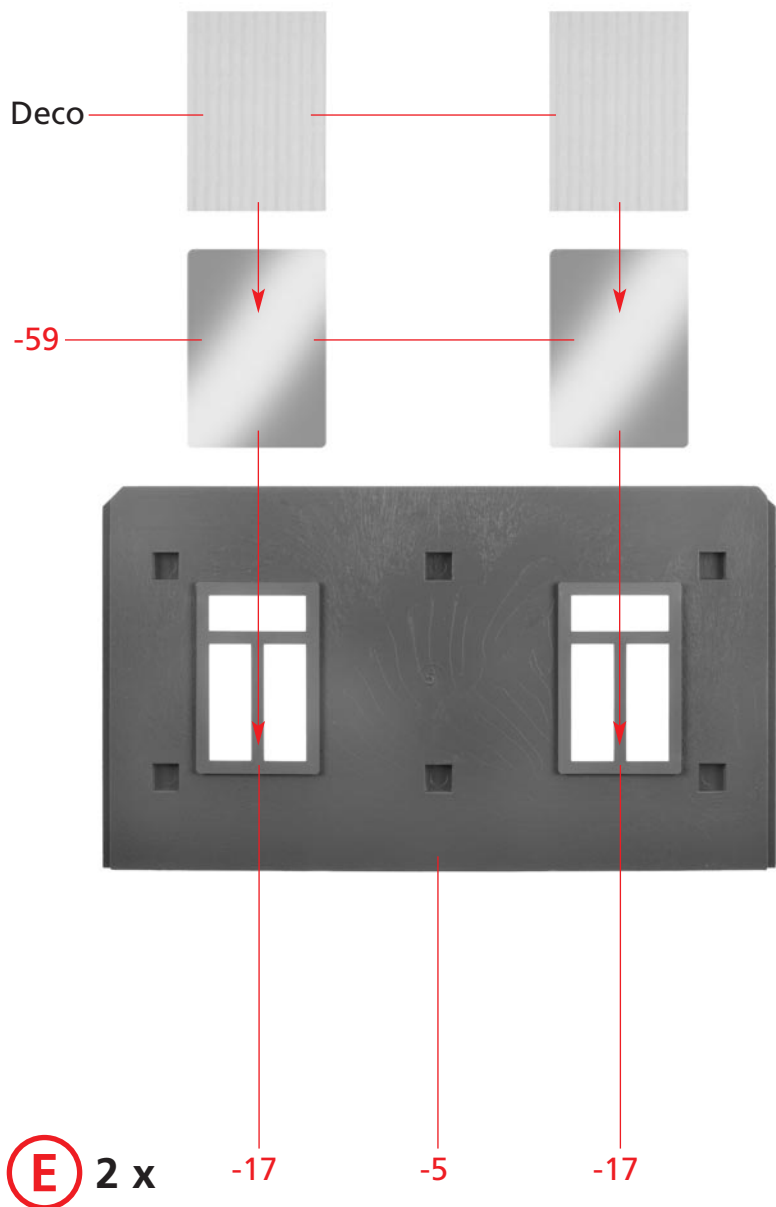

4

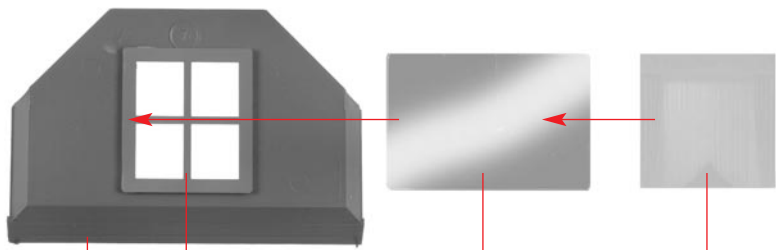

(H)

-7

-16

-64

Deco

-8

-9

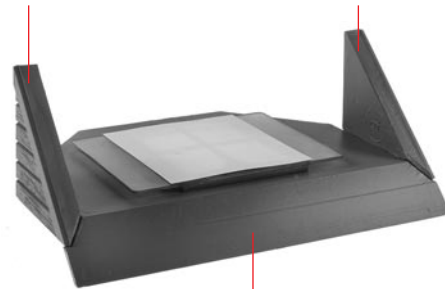

(I)

(H)

-12

-13

-11

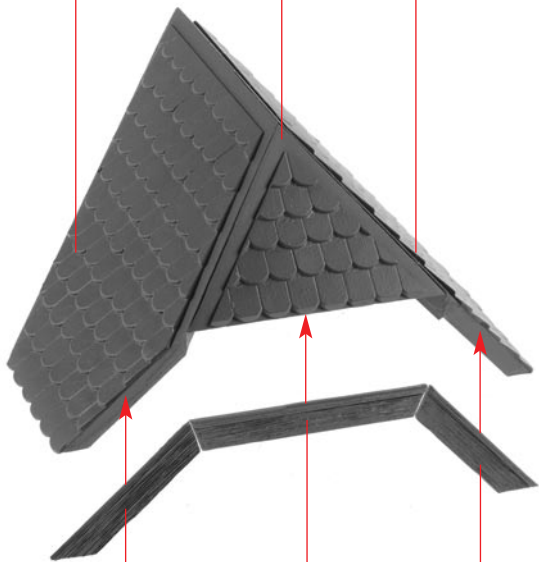

(J)

2 x

-34

-31

-33

(J)

(I)

(K)

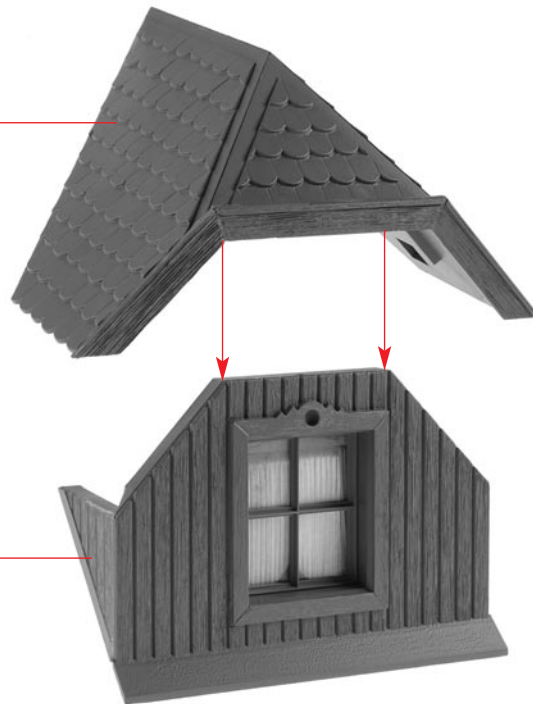

-13

-48

-10

-58

(K)

-10

-21

-22

-21

-22

(L)

-21

-22

-21

-22

(G)

-21

-22

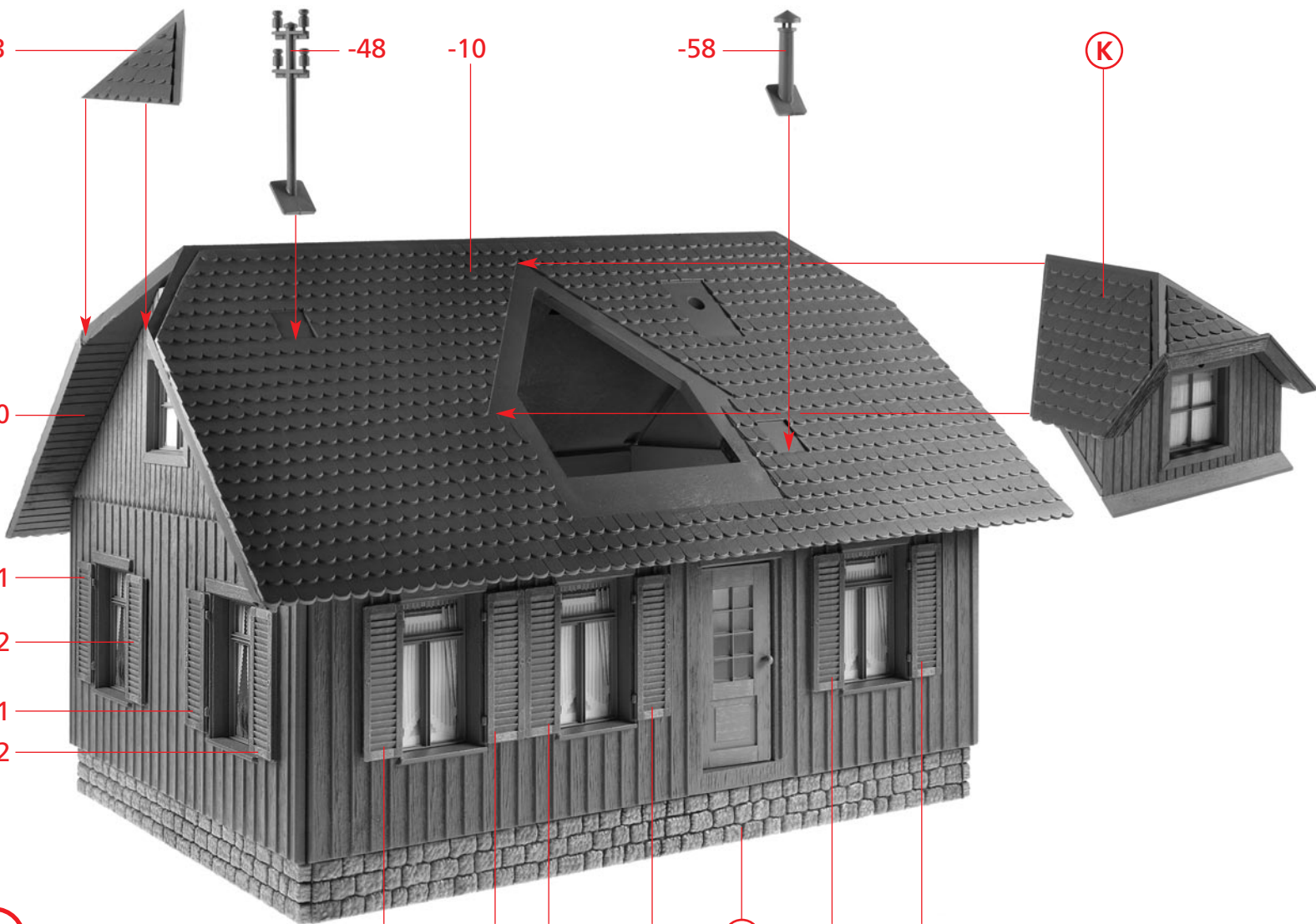

02-13

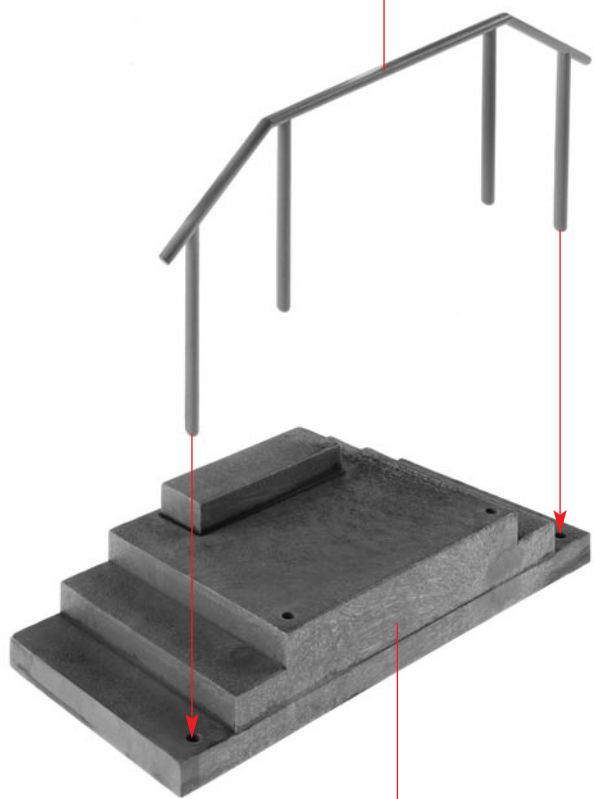

**M** 2 x

01-11

-46

-43

**N**

-44

-45

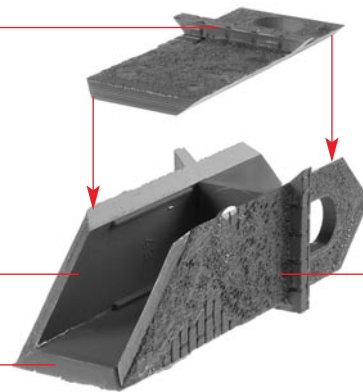

-69

-14

**N**

-14

**O**



-28

-32

-40

-29

-42

-39

-40

**O**

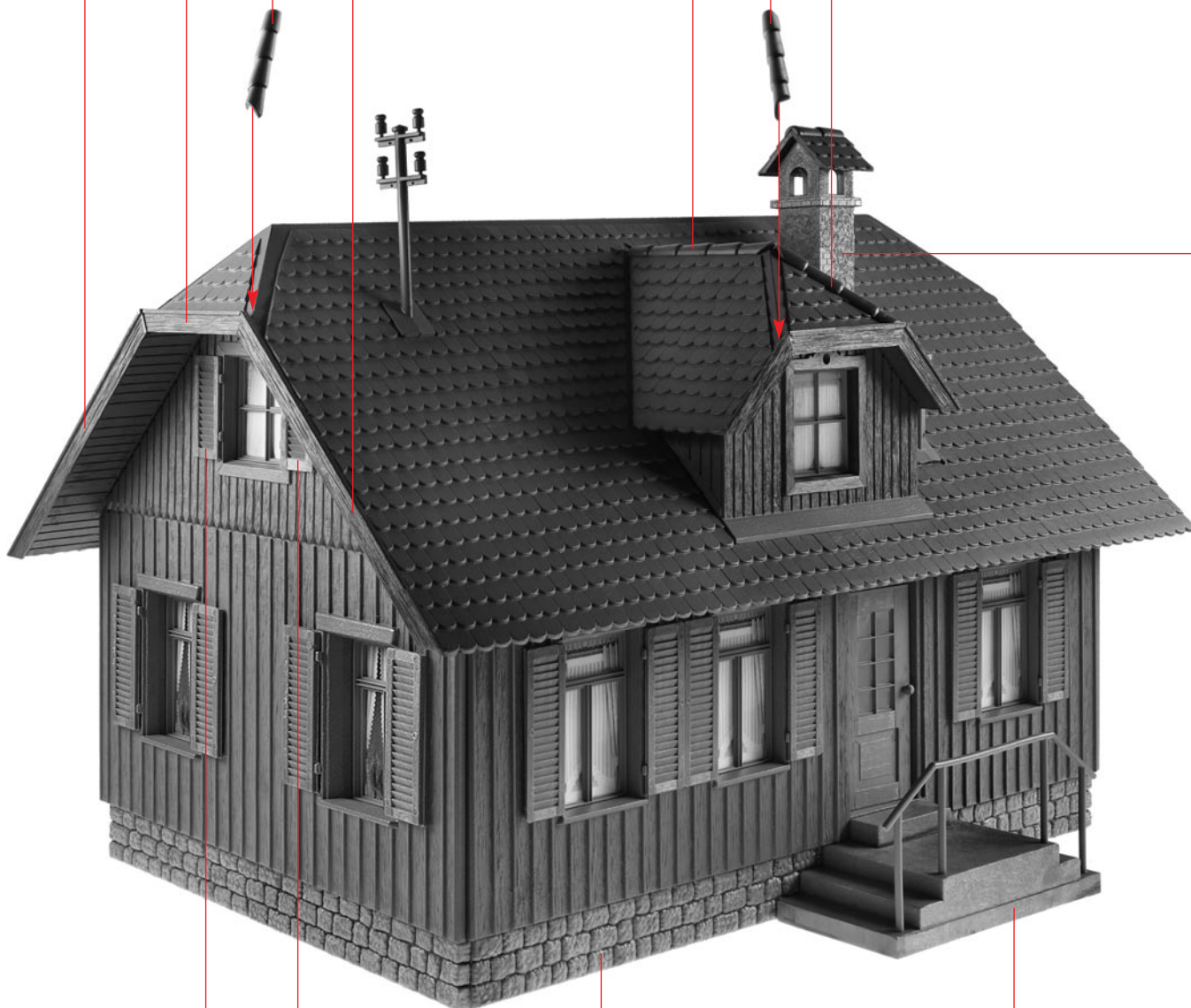

**P**

-26

-25

**L**

**M**

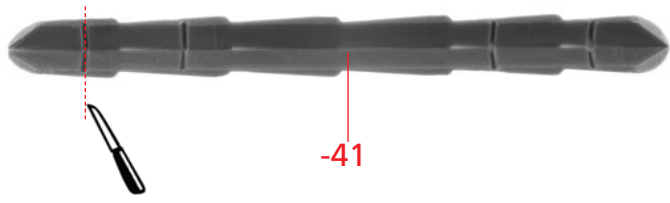

-41

Q

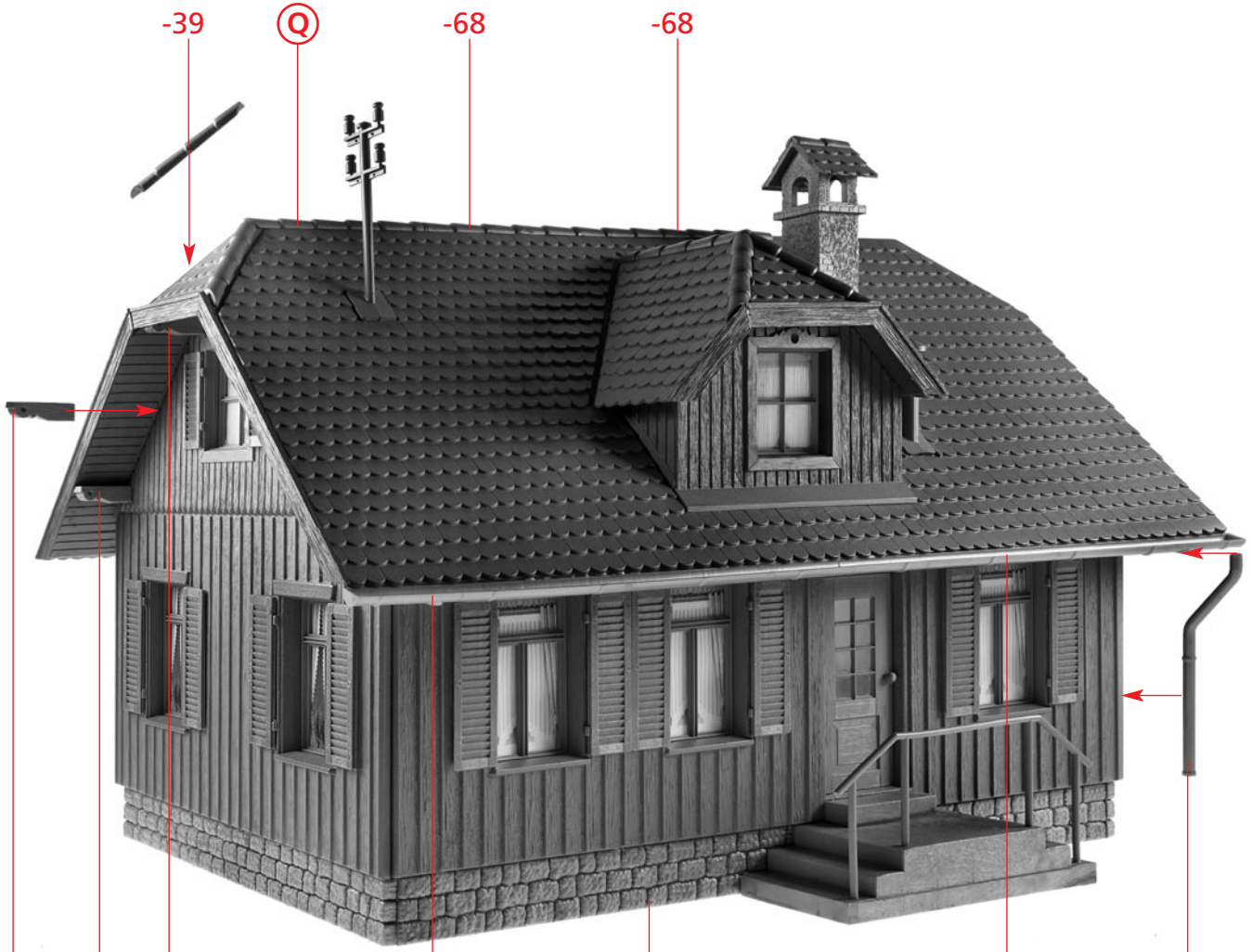

-39

Q

-68

-68

R

-19

-19

-19

-35

P

-36

-37

Deco

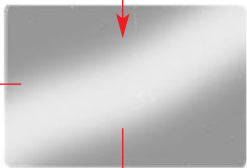
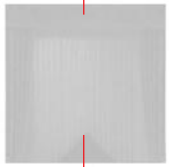

-64

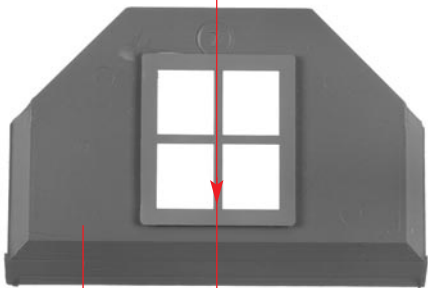

-7

-16

S

-8

-9



T

S

J

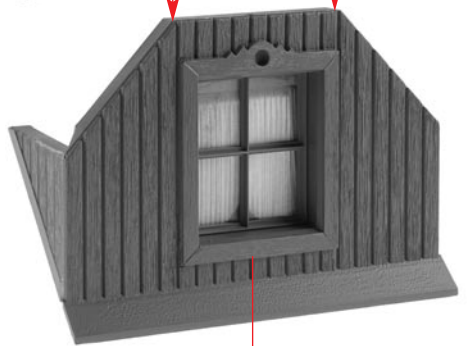
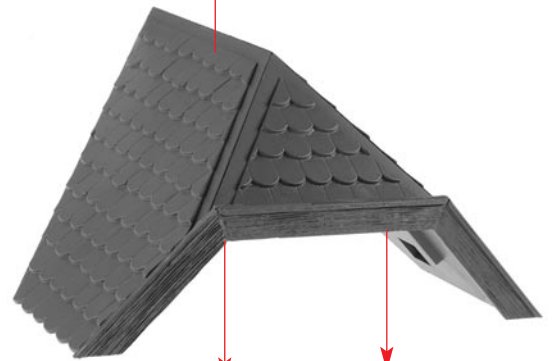

U

T

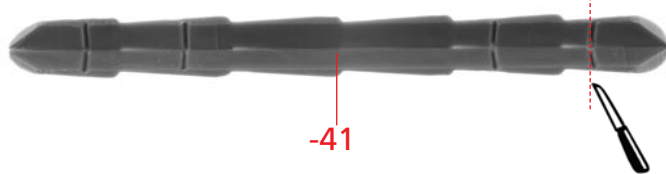

-41

V

V

-42

-40



-51

-49

U

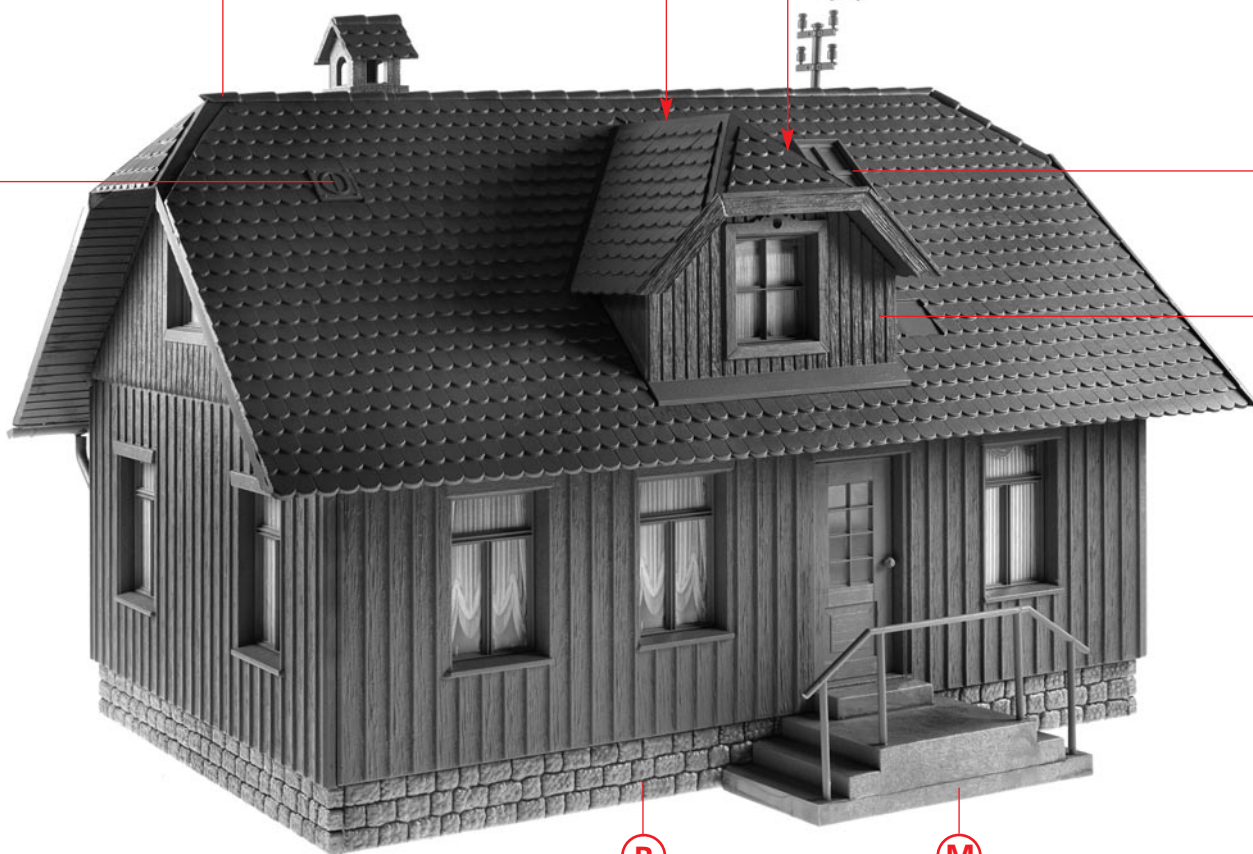

R

M

W

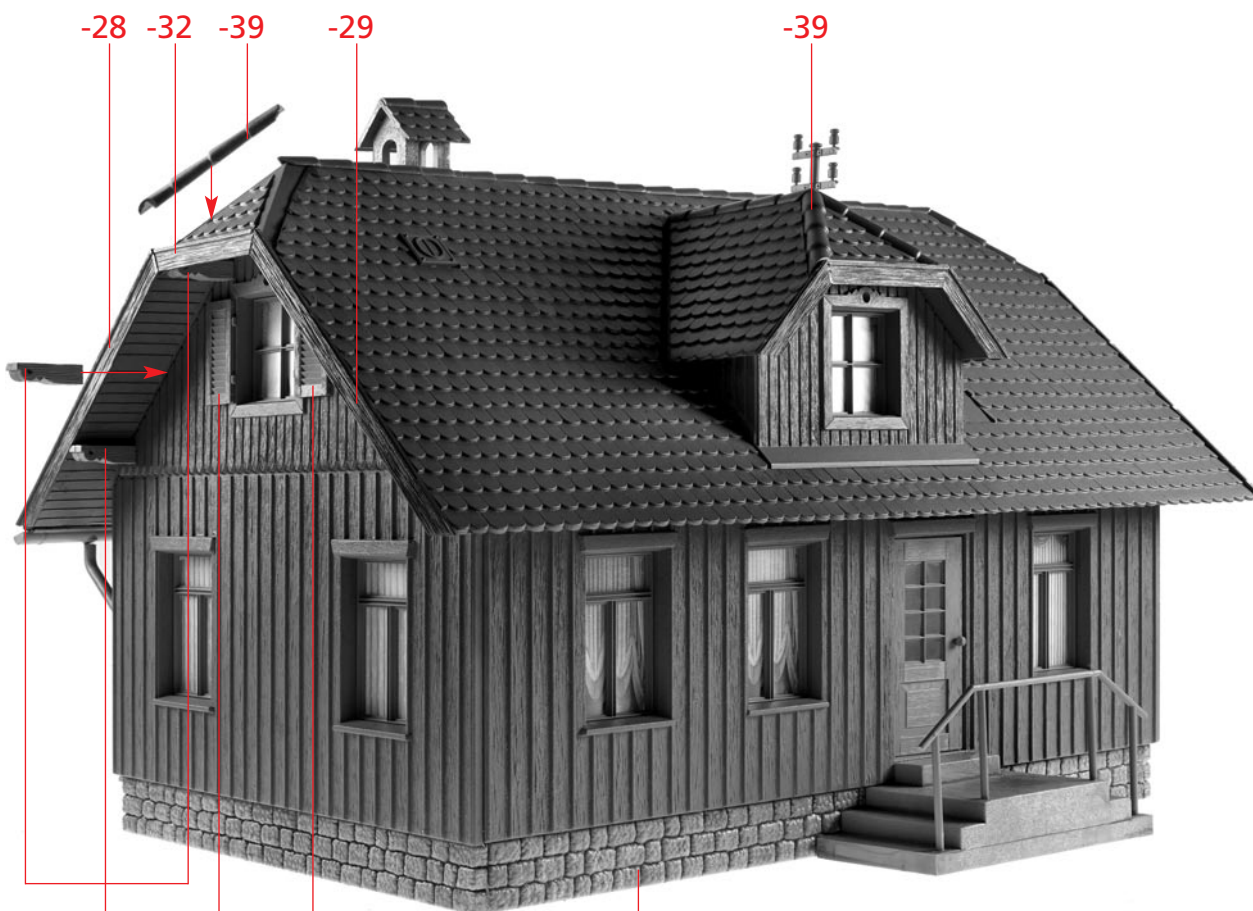

-28

-32

-39

-29

-39

-19

-26

-25

W

X

8

-40

-21

-22

-21

-22

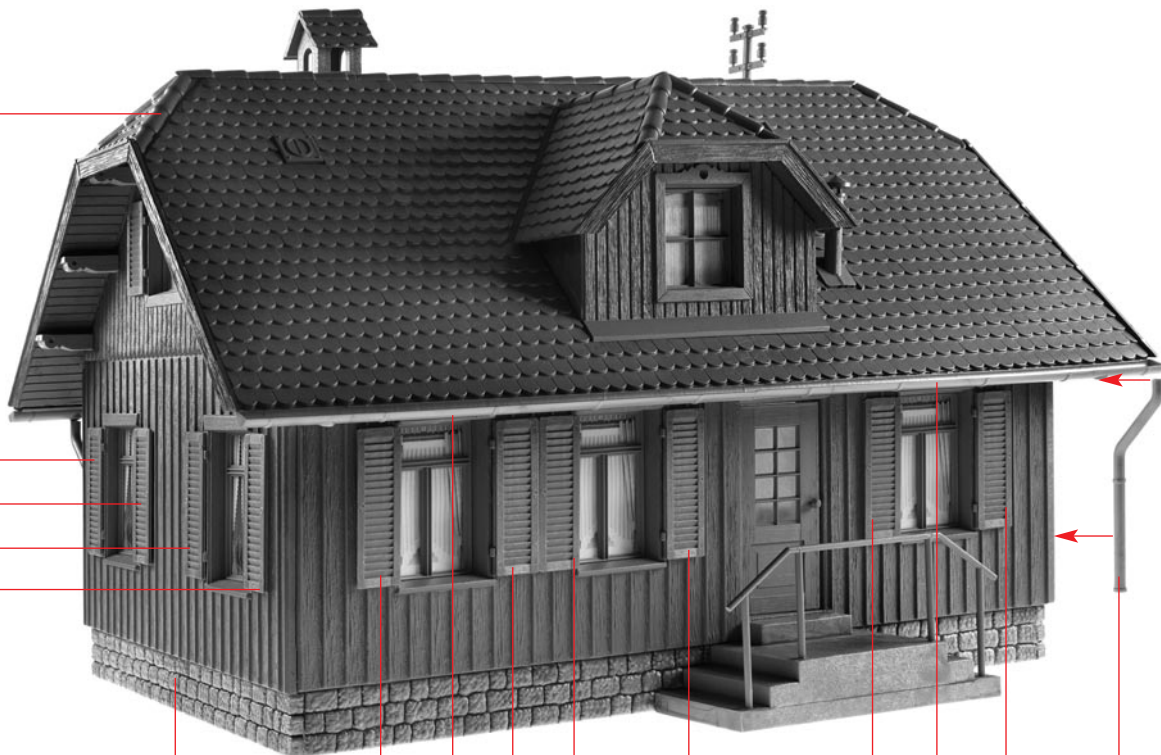

-21

-35

-22

-21

-22

-21

-36

-22

-37

(a)

(X)



-20

(a)

(b)



-20

(b)

(c)