

Bahnhof Bonn

Station  
Gare

Dieser Bausatz wurde sorgfältig geprüft. Sollte dennoch ein Teil fehlen oder fehlerhaft sein, dann fordern Sie dieses bitte unter Angabe der Bausatz-, Spritzling- und Teilenummer, die aus der Bauanleitung hervorgehen, bei uns an. Um Übermittlungsfehler auszuschließen, können wir Ersatzteilanforderungen nur noch schriftlich entgegennehmen!

The contents of this kit have been carefully checked and thus should correspond with components as listed in the „Parts List“. Nevertheless, and in the event that a part / component is missing or is faulty, please request the necessary part, stating article, slot and part number as listed on the instruction sheet.

Cet article a été contrôlé avec soin. Si, malgré nos précautions, une pièce manquait ou était défectueuse, veuillez nous la demander en précisant la référence de la maquette et le numéro de grappes et le numéro de la pièce, indiqués sur la notice de montage.

Das auf der Abbildung gezeigte Ausstattungsmaterial ist im Artikel nicht enthalten.  
The article does not include the designing material shown on the illustration.  
L'article est vendu sans le matériel de décoration figurant sur la photo.

Änderungen vorbehalten  
Sous réserve de modifications  
Subject to alterations  
Made in Germany

**Kibri® - Spielwarenfabrik GmbH**  
Hörschweiler Str. 1, D-72296 Schopfloch  
[www.kibri.com](http://www.kibri.com) / [info@kibri.com](mailto:info@kibri.com)

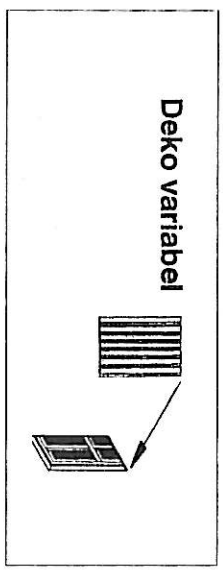

Inhalt - contents - contenu

Haft. Et. 377

| Pos. | Stück | Pos. | Stück | Pos.  | Stück | Pos. | Stück | Pos. | Stück | Pos. | Stück | Pos. | Stück | Pos. | Stück |
|------|-------|------|-------|-------|-------|------|-------|------|-------|------|-------|------|-------|------|-------|
| H756 | 4     | P917 | 4     | P950  | 1     | P987 | 1     | R116 | 1     | R152 | 1     | R185 | 1     | R215 | 1     |
| H757 | 2     | P918 | 22    | P951  | 1     | P988 | 1     | R117 | 2     | R153 | 1     | R186 | 2     | R216 | 1     |
| H758 | 1     | P919 | 4     | P952  | 1     | P989 | 1     | R118 | 2     | R154 | 1     | R187 | 1     |      |       |
| H759 | 1     | P920 | 2     | P953  | 1     | P990 | 1     | R119 | 2     | R155 | 2     | R188 | 2     | R217 | 1     |
| H760 | 1     | P921 | 2     | P954  | 1     | P991 | 1     | R120 | 1     | R156 | 2     | R189 | 4     | R218 | 1     |
| H761 | 1     | P922 | 2     | P955  | 1     | P992 | 1     | R121 | 1     | R157 | 2     | R190 | 1     |      |       |
| H762 | 1     | P923 | 2     | P956  | 1     | P993 | 1     | R122 | 1     | R158 | 1     |      |       | R219 | 1     |
| H763 | 1     | P924 | 2     | P957  | 1     |      |       | R123 | 1     | R159 | 1     | R191 | 1     | R220 | 1     |
| H764 | 1     | P925 | 2     | P958  | 1     | P994 | 1     | R124 | 1     | R160 | 1     | R192 | 4     | R221 | 2     |
|      |       | P926 | 2     | P959  | 2     | P995 | 1     | R125 | 2     | R161 | 1     | R193 | 2     | R222 | 2     |
| P900 | 1     | P927 | 3     | P960  | 2     | P996 | 1     | R126 | 2     | R162 | 4     | R194 | 2     | R223 | 2     |
|      |       | P928 | 2     | P961  | 1     | P997 | 1     | R126 | 1     | R163 | 6     | R195 | 2     | R224 | 1     |
| P901 | 1     | P929 | 2     | P962  | 2     | P998 | 1     | R130 | 1     | R164 | 1     |      |       | R225 | 4     |
|      |       | P930 | 2     | P963  | 1     | P999 | 2     |      |       | R165 | 1     | R196 | 1     | R226 | 1     |
| P902 | 1     | P931 | 2     | P964  | 1     | R100 | 1     | R131 | 1     | R166 | 1     | R197 | 4     | R227 | 1     |
|      |       | P932 | 2     | P965  | 2     | R101 | 1     | R132 | 1     | R167 | 1     | R198 | 2     | R228 | 2     |
| P903 | 4     | P933 | 2     | P966  | 2     | R102 | 1     | R133 | 8     | R168 | 1     |      |       | R229 | 2     |
| P904 | 4     | P934 | 2     | P967  | 2     | R103 | 1     | R134 | 1     | R169 | 1     | R199 | 2     | R230 | 1     |
| P905 | 16    | P935 | 2     | P968  | 1     |      |       |      |       |      |       | R200 | 6     | R231 | 1     |
|      |       | P936 | 2     | P969  | 1     | R104 | 10    | R135 | 1     | R170 | 1     | R201 | 4     | R232 | 1     |
| P906 | 1     | P937 | 2     | P970  | 1     |      |       | R136 | 1     | R171 | 2     | R202 | 4     | R233 | 3     |
| P907 | 1     | P938 | 2     | P971  | 2     | R106 | 1     | R137 | 1     | R172 | 1     | R203 | 6     | R234 | 2     |
|      |       | P939 | 4     | P972  | 1     | R107 | 1     | R138 | 1     | R173 | 1     | R204 | 4     | R235 | 1     |
| P908 | 1     | P940 | 4     | P973  | 1     | R108 | 1     | R139 | 1     | R174 | 1     | R205 | 1     | R236 | 1     |
| P909 | 1     | P941 | 8     | P973A | 2     | R109 | 1     | R140 | 1     | R175 | 1     | R206 | 1     | R237 | 1     |
|      |       | P942 | 4     | P974  | 1     |      |       | R141 | 1     | R176 | 1     | R207 | 1     | R238 | 1     |
| P910 | 1     | P942 | 2     | P975  | 1     | R110 | 4     | R142 | 1     | R177 | 1     | R208 | 1     | R239 | 1     |
| P911 | 1     | P943 | 2     | P976  | 1     | R111 | 3     | R143 | 5     | R178 | 1     | R209 | 1     | R240 | 1     |
| P912 | 1     | P944 | 8     | P977  | 1     | R112 | 5     | R144 | 20    | R179 | 1     | R210 | 1     | R241 | 1     |
| P913 | 1     | P945 | 4     | P978  | 1     | R113 | 34    | R145 | 4     | R180 | 1     | R211 | 1     | R242 | 2     |
| P914 | 1     | P946 | 4     | P979  | 1     | R114 | 2     | R146 | 4     | R181 | 1     | R212 | 1     | R243 | 6     |
| P915 | 1     | P947 | 4     | P980  | 1     | R115 | 16    | R147 | 4     | R182 | 1     | R213 | 1     | R244 | 1     |
| P916 | 1     | P948 | 2     | P981  | 2     |      |       | R148 | 4     | R183 | 1     | R214 | 2     | R245 | 1     |
|      |       | P949 | 2     | P982  | 1     |      |       | R149 | 4     | R184 | 1     |      |       | R246 | 1     |
|      |       |      |       | P983  | 1     |      |       | R150 | 3     |      |       |      |       |      |       |
|      |       |      |       | P984  | 1     |      |       | R151 | 3     |      |       |      |       |      |       |
|      |       |      |       | P985  | 1     |      |       |      |       |      |       |      |       |      |       |
|      |       |      |       | P986  | 1     |      |       |      |       |      |       |      |       |      |       |



# 9373 C

2

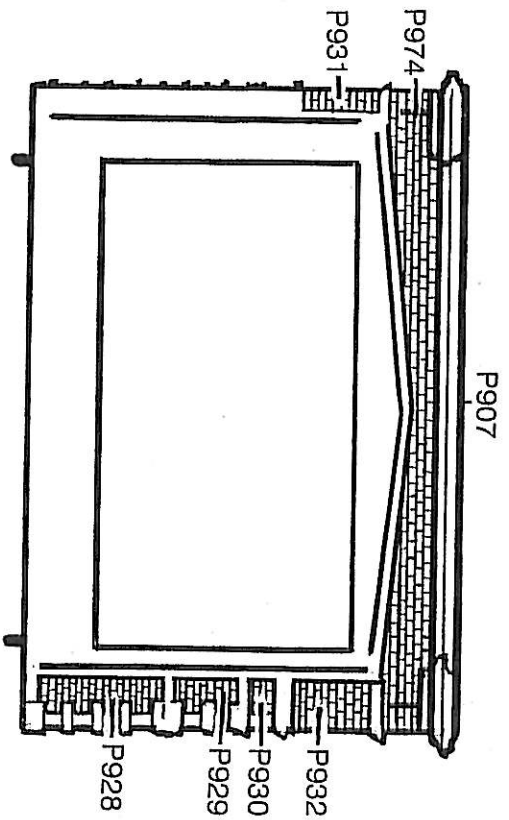

1 2x

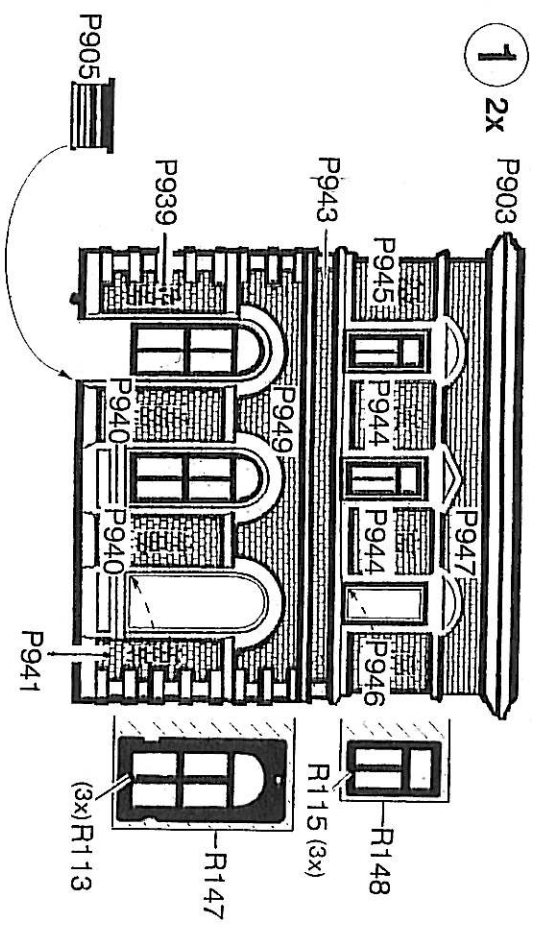

3

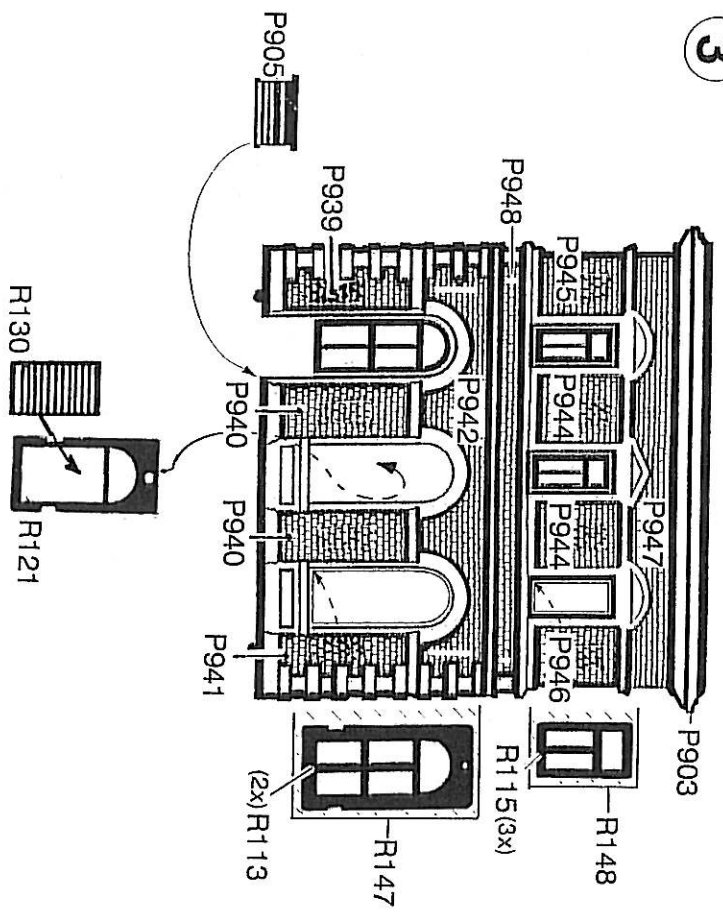

4

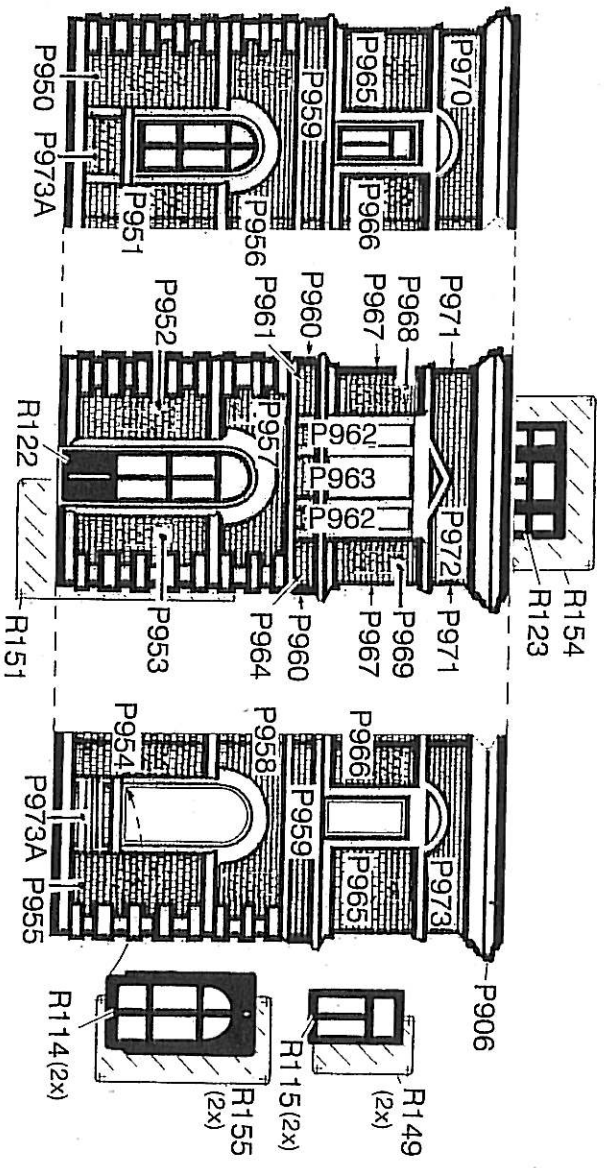

# 9373 D

7

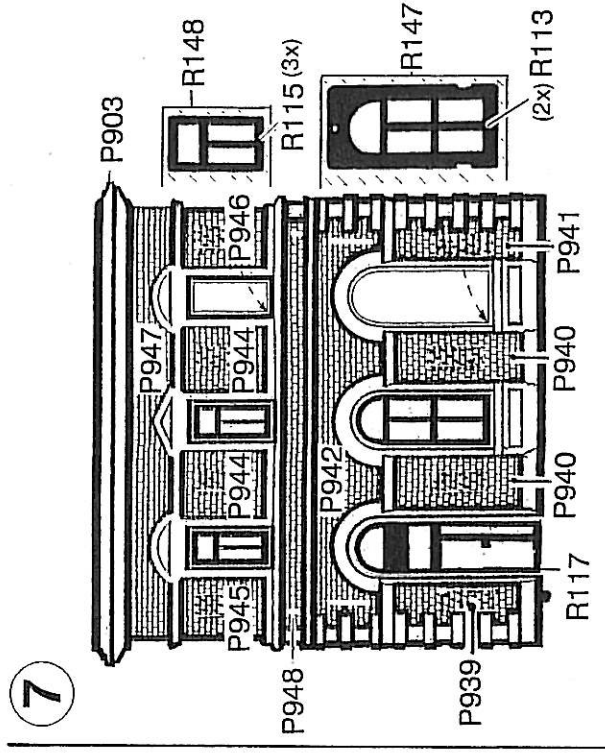

10

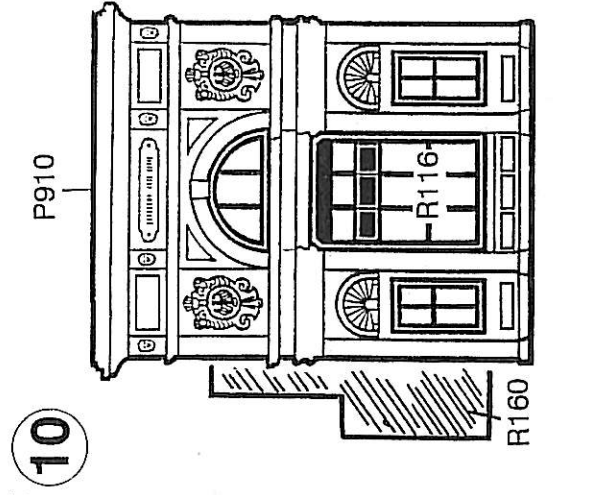

5

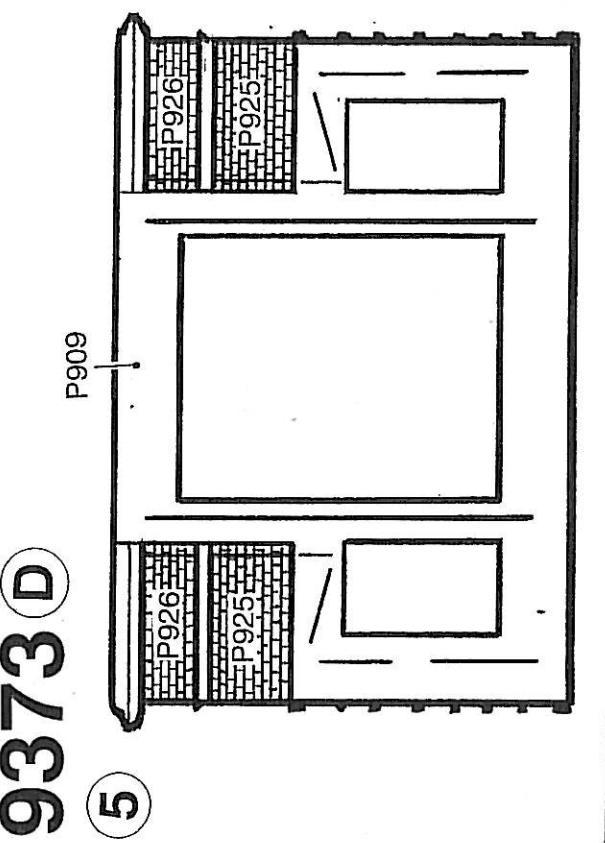

8

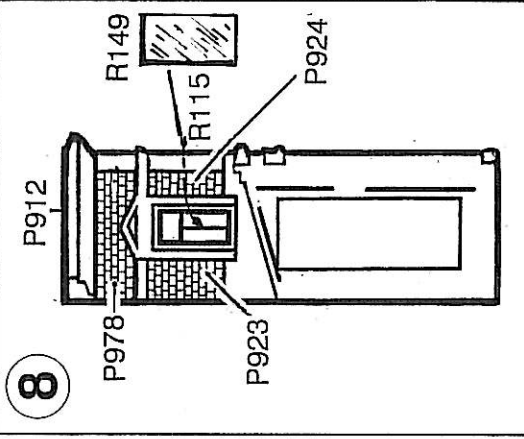

9

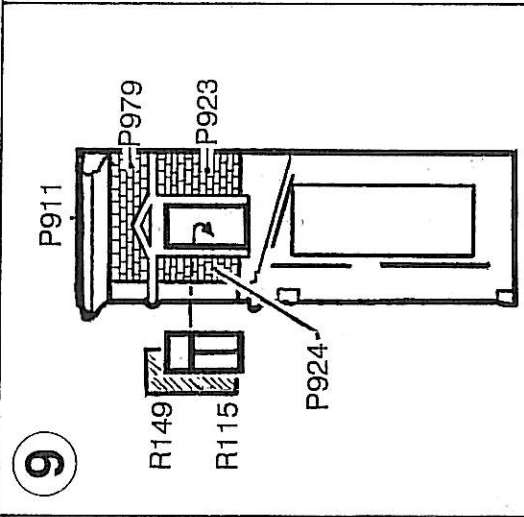

11

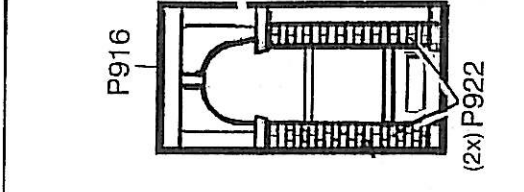

6

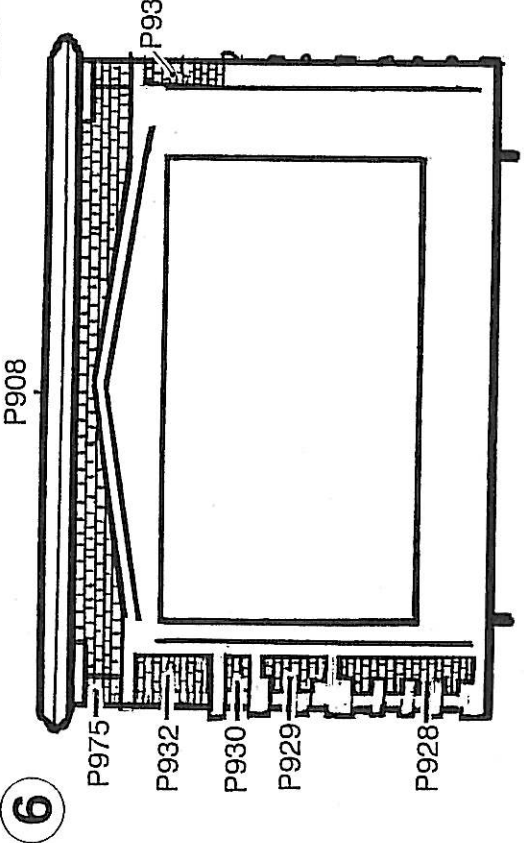

12

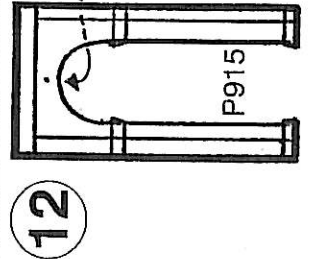

13

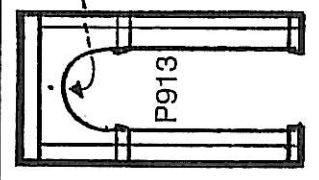

14

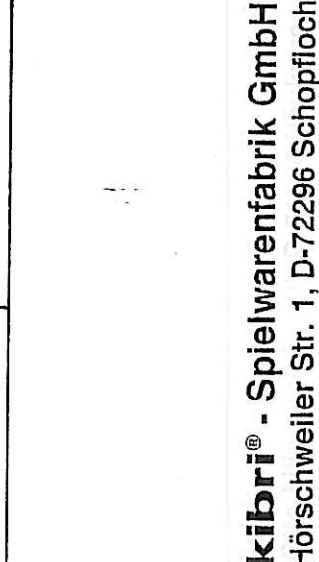
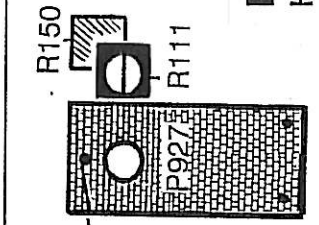
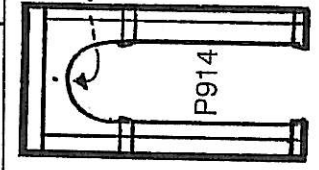

# 9373 F

17

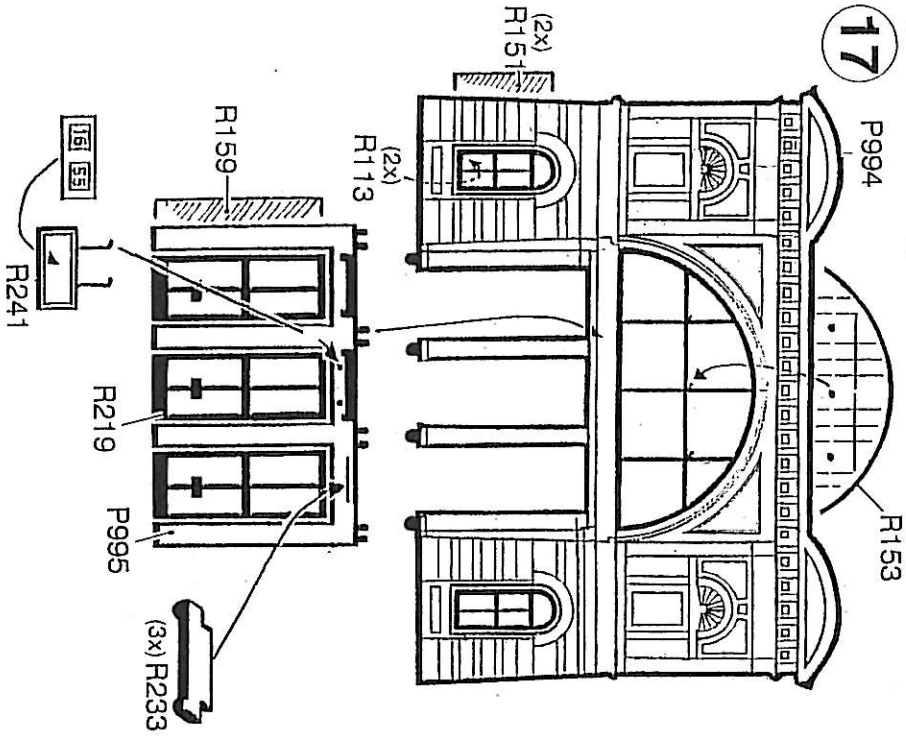

19

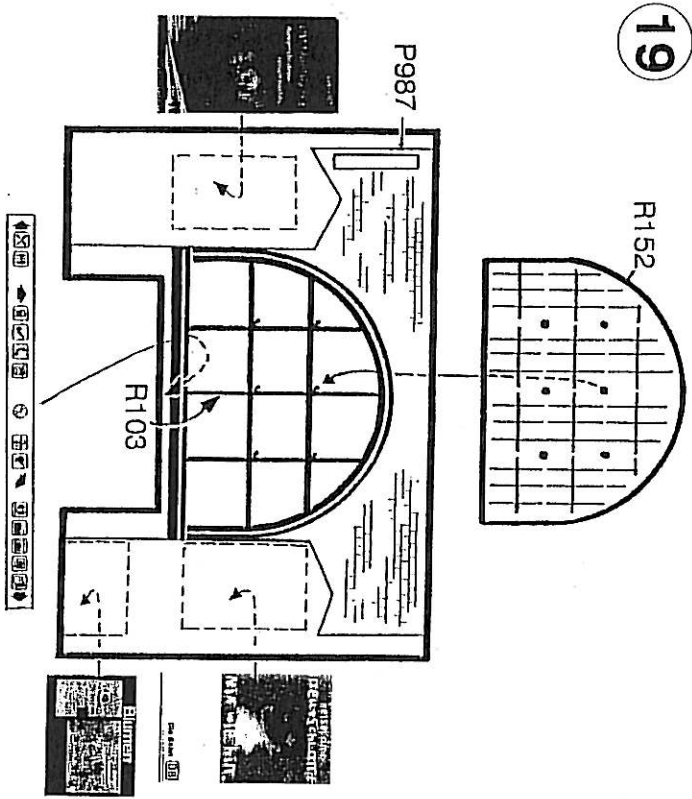

20

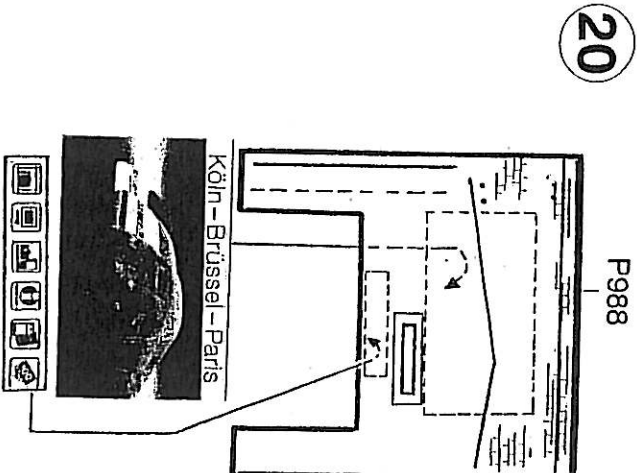

21

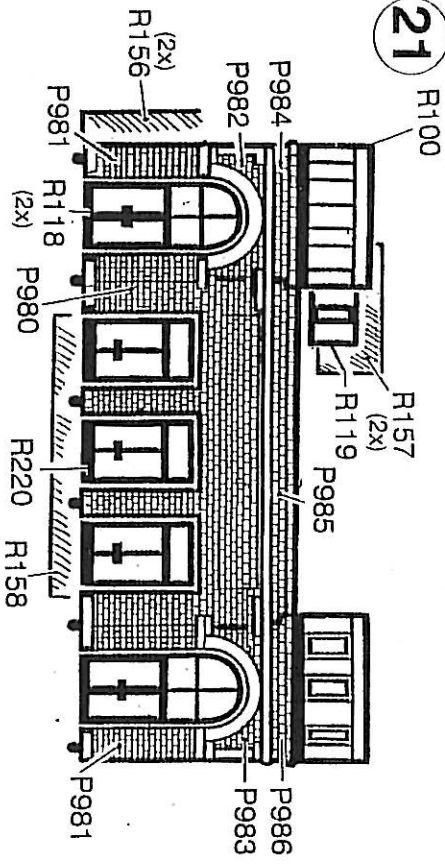

23

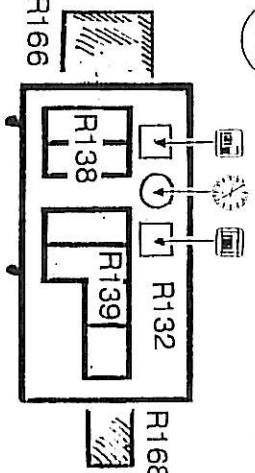

18

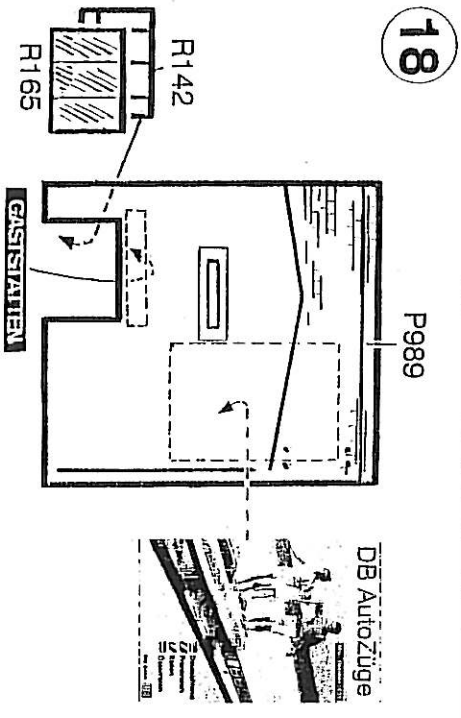

22

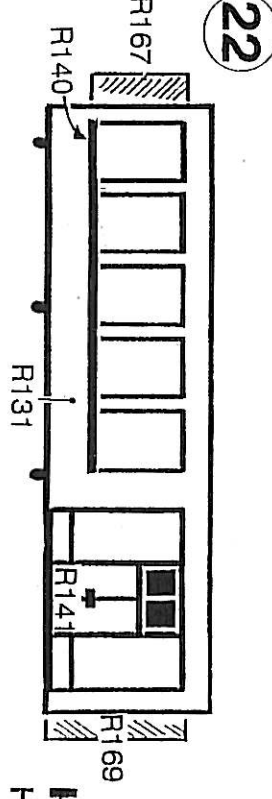

**kibri® - Spielwarenfabrik GmbH**  
Hörschweiler Str. 1, D-72296 Schopfloch

9373E

15

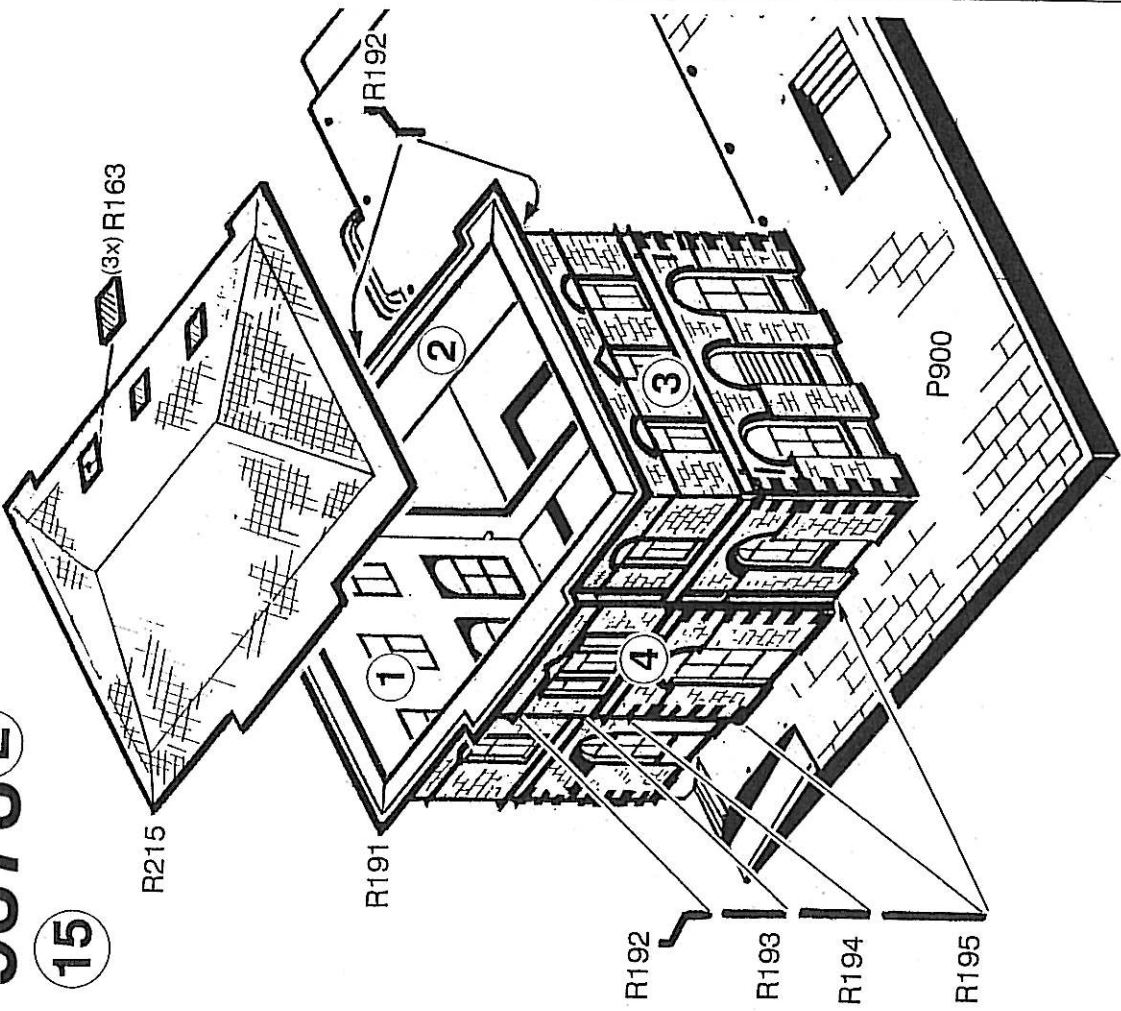

16

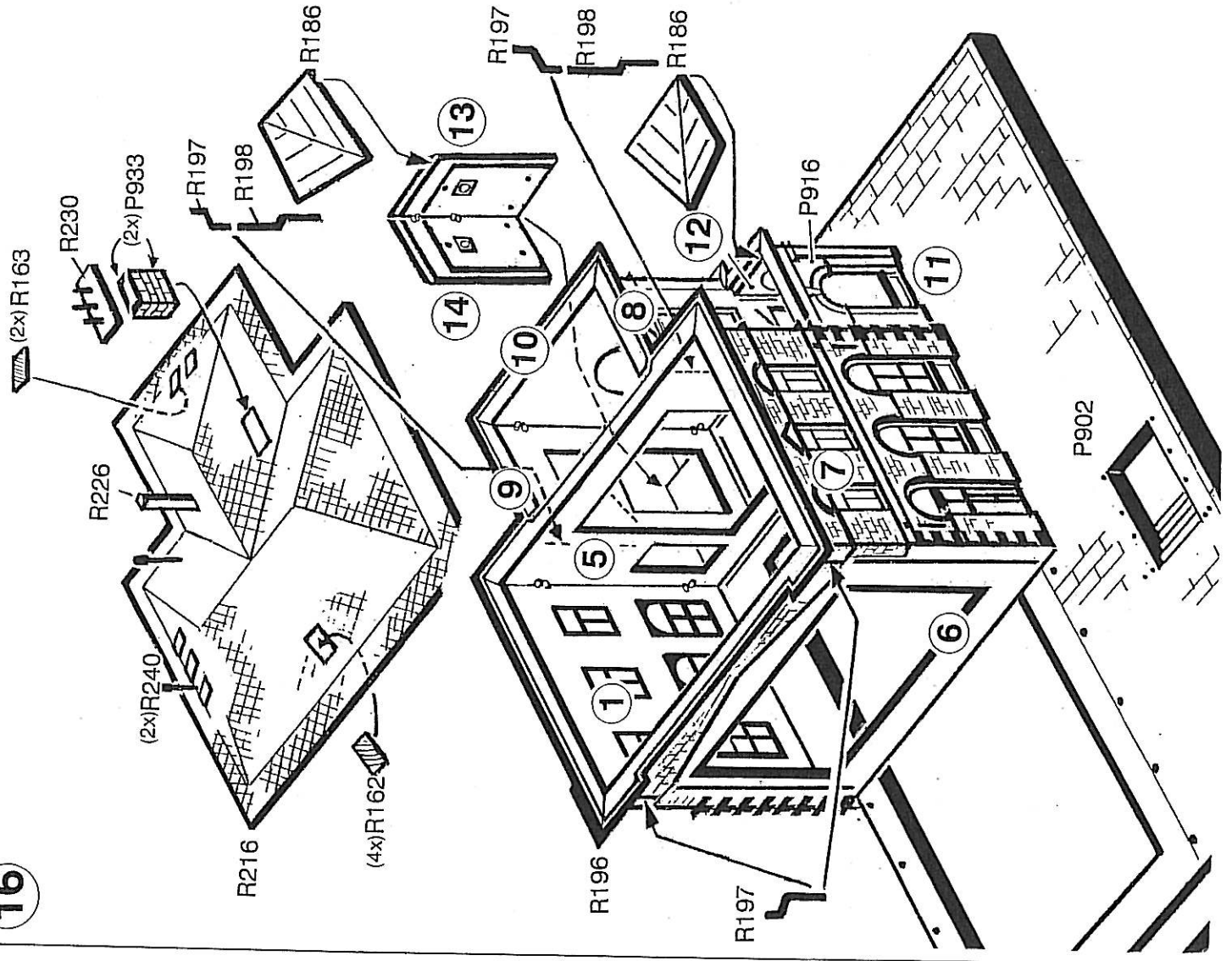

**kibri® - Spielwarenfabrik GmbH**  
 Hörschweiler Str. 1, D-72296 Schopfloch

24

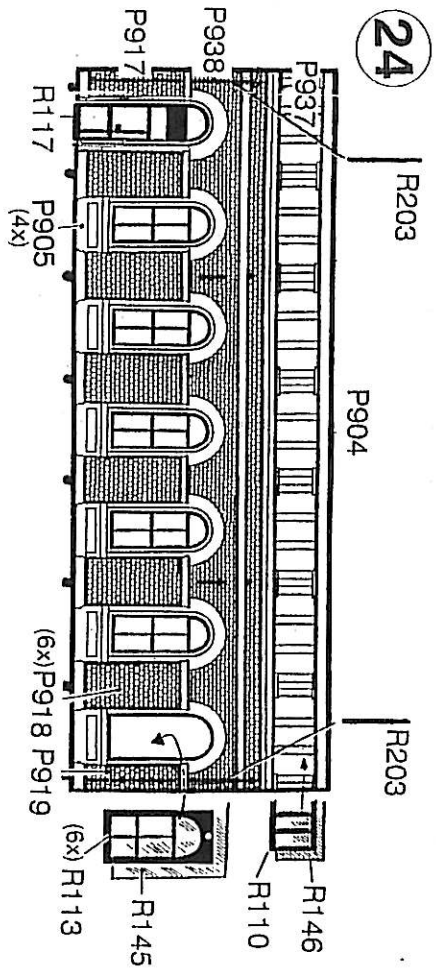

25

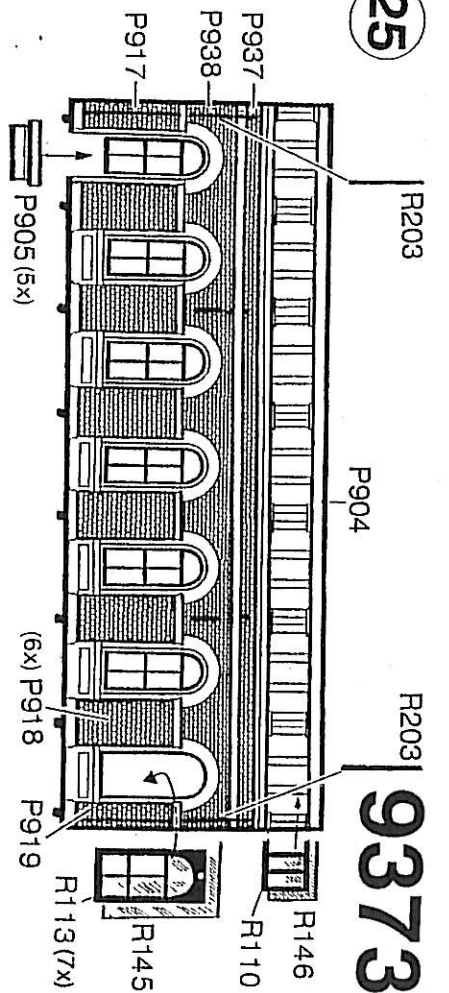

9373G

26

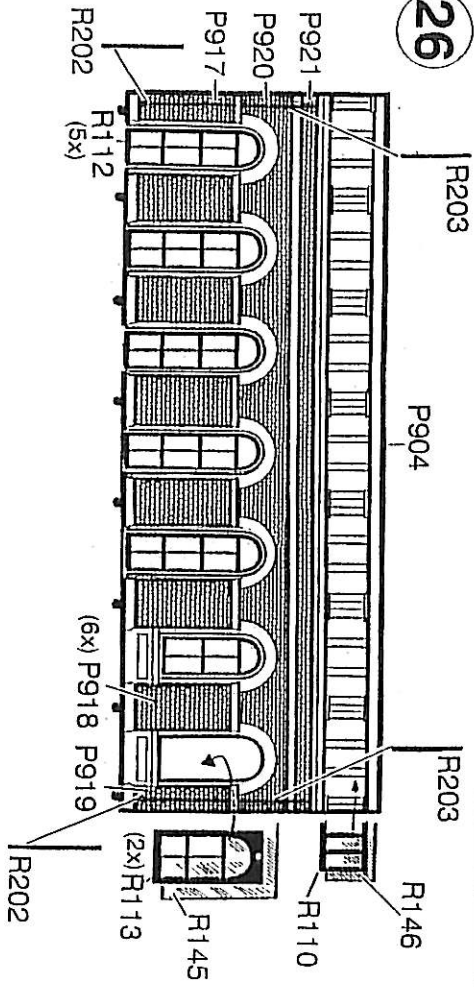

27

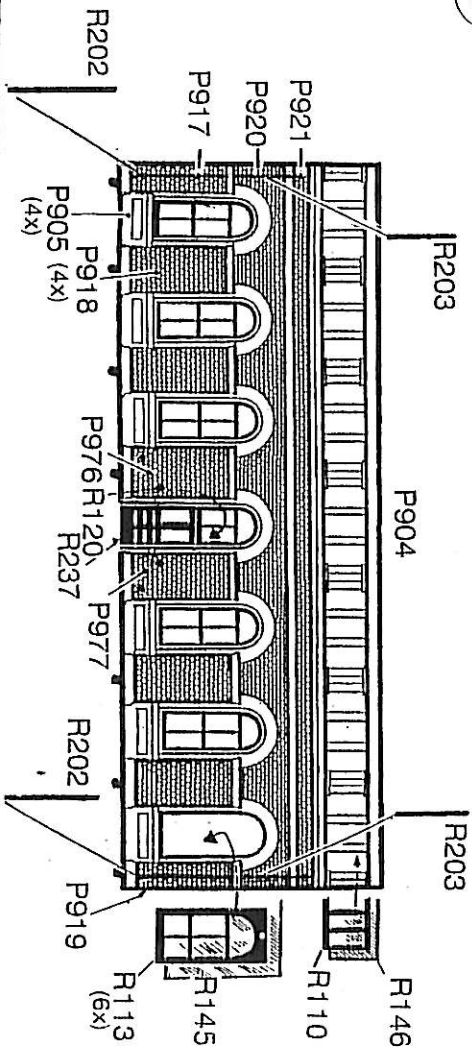

28

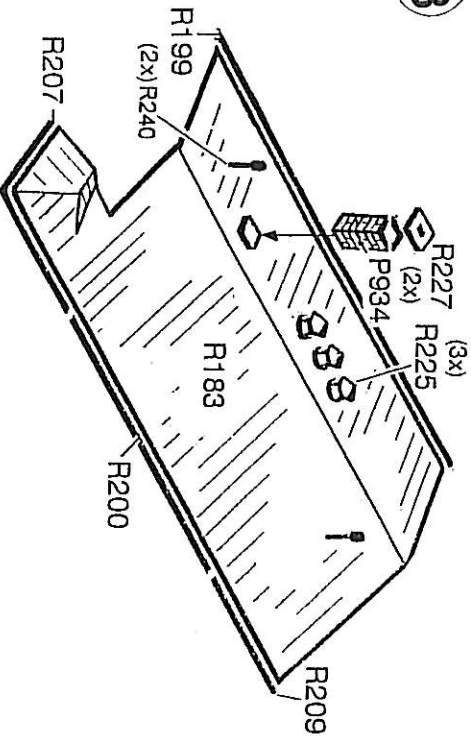

29

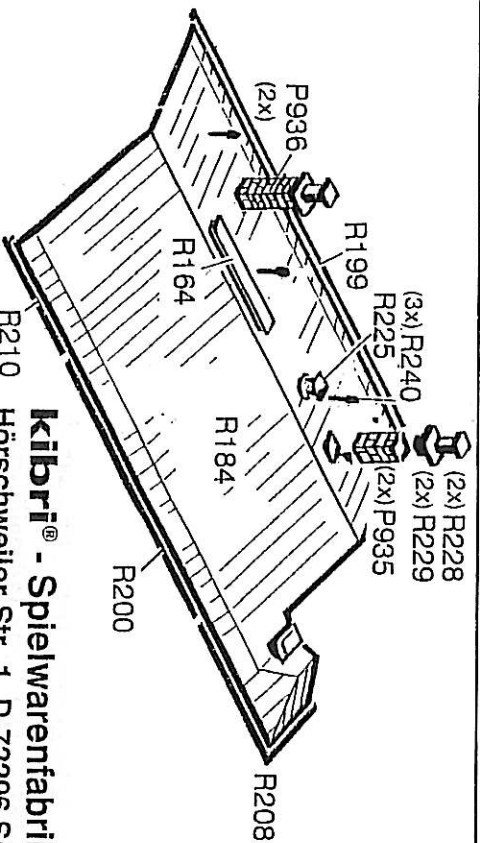

9373H

30

