

Nr. 3520
 Bauanleitung für „Bahnhof Benediktbeuern“, Nr. 3520
 Instructions for "Country station", No. 3520
 Instructions d'assemblage pour «Gare», No. 3520
 Bouwbeschrijving voor „Station Benediktbeuern“, No. 3520
 Instrucciones de montaje para «Estación», No. 3520
 Istruzione per la costruzione «Stazione Benediktbeuern», No. 3520

Bitte legen Sie die Einzelteile nach Buchstabengruppen zusammen und beginnen Sie dann den Zeichnungen entsprechend mit dem Zusammenbau.

Arrange the individual parts by letter groups, and then begin assembling in accordance with the drawings.

Pour l'assemblage, il faut suivre l'ordre alphabétique des dessins, et dans chaque dessin l'ordre numérique des pièces.

De onderdelen volgens lettergroepen indelen en overeenkomstig de afbeeldingen monteren.

Ordenar las piezas por el orden de las letras indicadas para empezar con el montaje siguiendo el croquis.

Pregho mettere insieme i pezzi singoli secondo gruppi alfabetici, poi cominciare il montaggio corrispondente ai disegni.

Inhalt/Contents/Contenu/Inhoud

24417 = 4 x	28655 = 1 x	28695 = 1 x	28735 = 1 x	28760 = 4 x	28789 = 1 x
24855 = 2 x	28656 = 1 x	28696 = 1 x	28737 = 2 x	28761 = 2 x	28790 = 1 x
25344 = 15 x	28663 = 1 x	28697 = 1 x	28738 = 1 x	28762 = 2 x	28791 = 1 x
25984 = 1 x	28664 = 2 x	28698 = 1 x	28739 = 1 x	28763 = 1 x	28792 = 1 x
26301 = 1 x	28665 = 1 x	28699 = 1 x	28740 = 3 x	28765 = 1 x	28793 = 2 x
26624 = 10 x	28666 = 2 x	28700 = 2 x	28741 = 1 x	28766 = 1 x	28795 = 1 x
26779 = 5 x	28668 = 1 x	28702 = 1 x	28742 = 1 x	28767 = 2 x	28796 = 1 x
26801 = 1 x	28669 = 1 x	28716 = 2 x	28744 = 1 x	28768 = 1 x	28797 = 4 x
26802 = 4 x	28670 = 1 x	28720 = 4 x	28745 = 1 x	28769 = 4 x	28798 = 2 x
27115 = 1 x	28671 = 2 x	28721 = 1 x	28746 = 1 x	28770 = 4 x	28799 = 1 x
27582 = 4 x	28672 = 2 x	28722 = 2 x	28747 = 1 x	28771 = 4 x	28800 = 2 x
28635 = 1 x	28673 = 4 x	28723 = 4 x	28748 = 1 x	28772 = 2 x	28801 = 1 x
28637 = 4 x	28677 = 1 x	28724 = 2 x	28749 = 1 x	28773 = 2 x	28802 = 1 x
28638 = 15 x	28682 = 7 x	28725 = 1 x	28750 = 1 x	28774 = 1 x	28803 = 4 x
28639 = 10 x	28683 = 1 x	28727 = 1 x	28751 = 2 x	28775 = 1 x	28804 = 1 x
28640 = 1 x	28684 = 3 x	28728 = 1 x	28752 = 2 x	28776 = 2 x	28805 = 1 x
28642 = 1 x	28686 = 2 x	28729 = 1 x	28753 = 4 x	28777 = 1 x	28949 = 1 x
28643 = 2 x	28687 = 4 x	28730 = 1 x	28754 = 2 x	28778 = 2 x	
28644 = 1 x	28688 = 3 x	28731 = 1 x	28755 = 2 x	28785 = 1 x	
28652 = 1 x	28689 = 2 x	28732 = 1 x	28756 = 1 x	28786 = 1 x	
28653 = 1 x	28690 = 3 x	28733 = 1 x	28758 = 1 x	28787 = 1 x	
28654 = 1 x	28691 = 2 x	28734 = 1 x	28759 = 1 x	28788 = 1 x	

Unsere Erzeugnisse entsprechen den Sicherheitsanforderungen an Spielzeug und dürfen deshalb das Verbandszeichen

DIN tragen.

Wir verwenden den recycelfähigen Kunststoff Polystyrol



Zum Erwerb dieses **VOLLMER**-Bausatzes gratulieren wir Ihnen. Sie haben beim Zusammenfügen bestimmt viel Freude, weil alles paßt und somit keine Nacharbeit erforderlich ist.

Ein erstklassiger Kunststoff-Kleber gehört dazu, um jede Enttäuschung auszuschließen. (Ist nicht im Bausatz enthalten)

VOLLMER Suprezement S 30 und Supranol 2000 – die giftfreien Superkleber – kleben sauber und verschweißen dauerhaft. Durch hohen Verzögerungseffekt wird vorzeitiges Austrocknen verhindert.

Suprezement S 30 mit handlichem Pinselverschluss für großflächige Teile.

Supranol 2000 mit Feinkanüle für punktgenaues Arbeiten in der ergonomisch richtig geformten Flasche.

Irrtum und Änderungen vorbehalten.

Vollmer GmbH & Co. KG, Postfach 40 09 20, D-70409 Stuttgart



Printed in Germany – Imprimé en Allemagne
 Gedruckt in Duitland

(A)

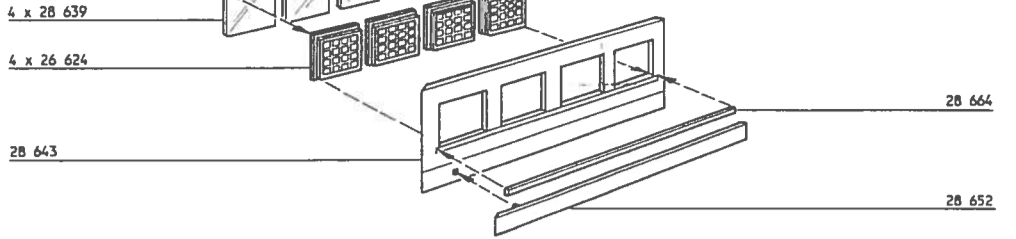

(B)

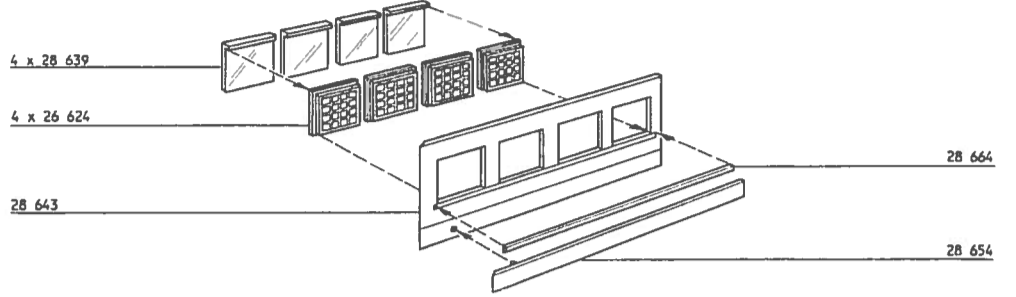

(C)

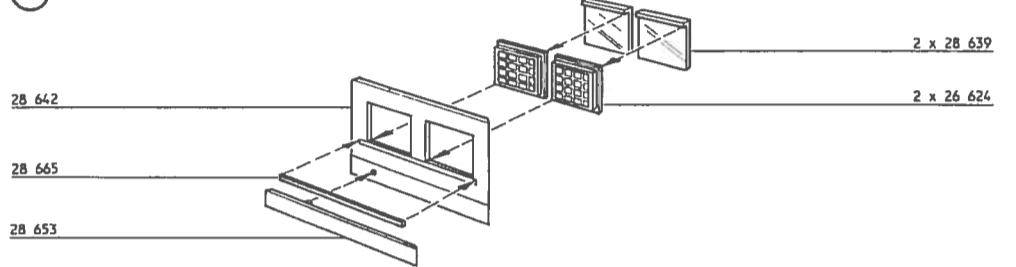

(D)

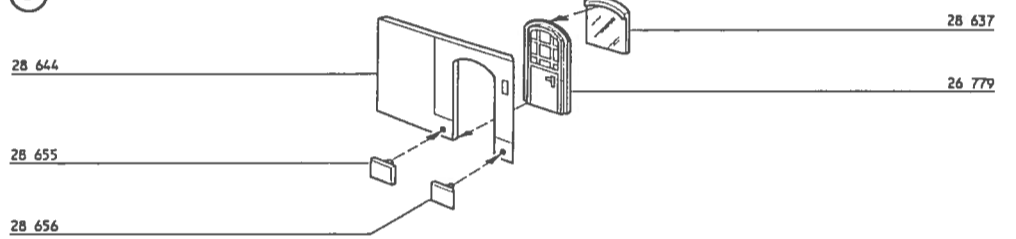

2

(E)

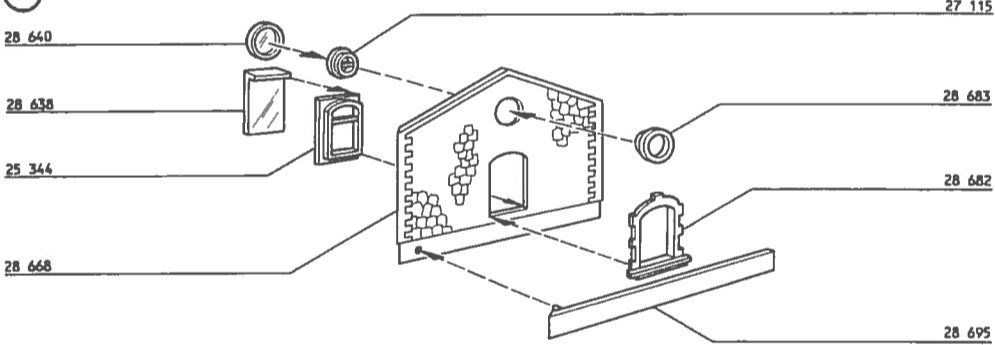

(F)

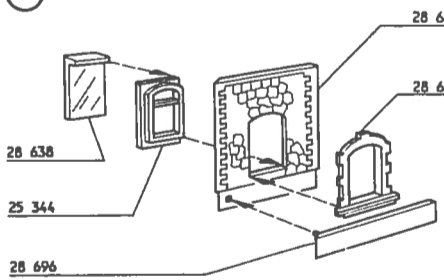

(G)

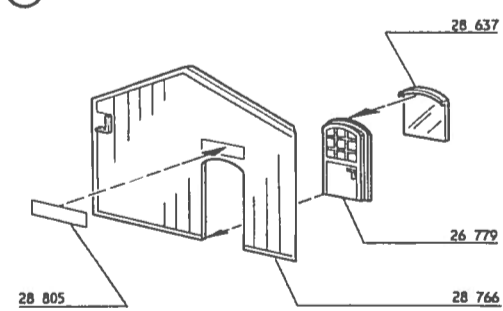

(H)

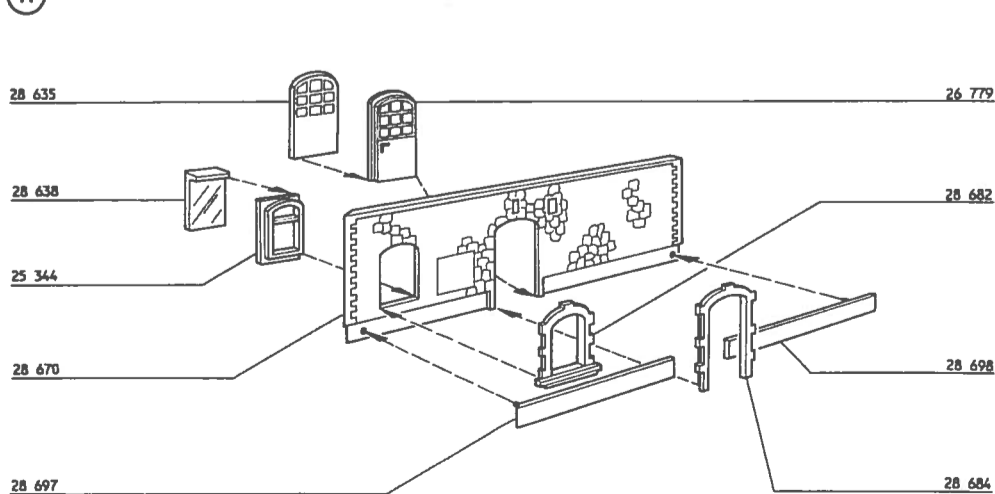

3

(I)

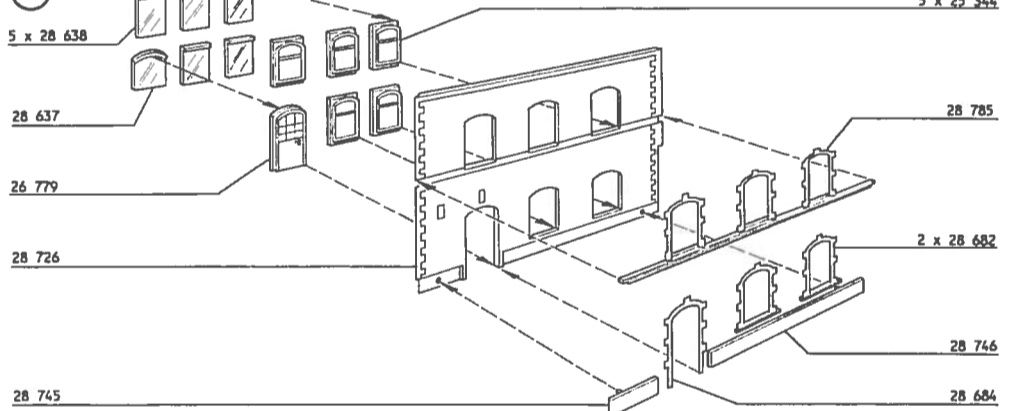

(J)

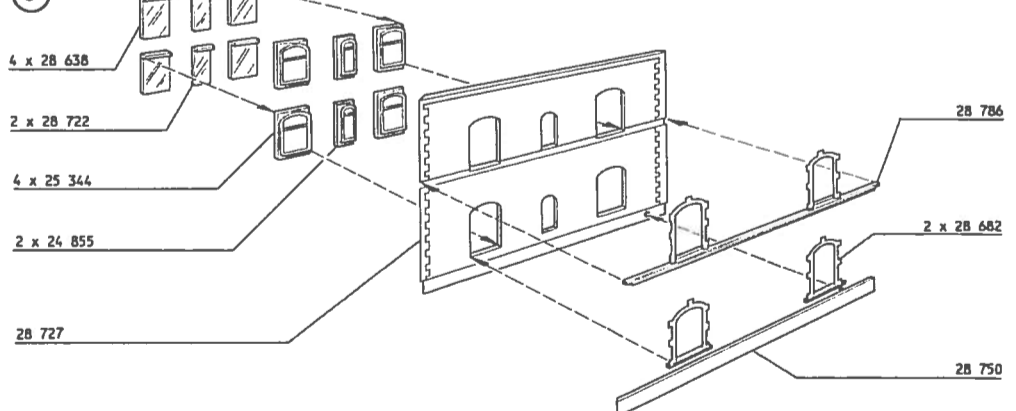

(K)

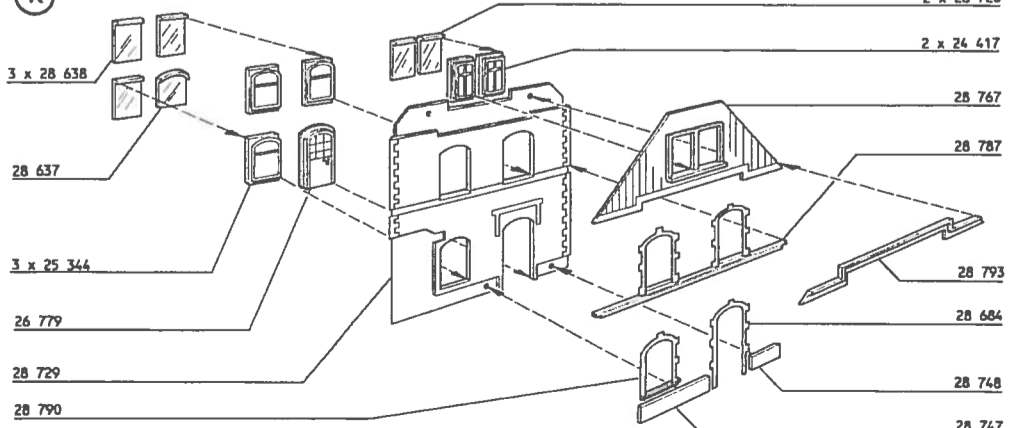

4

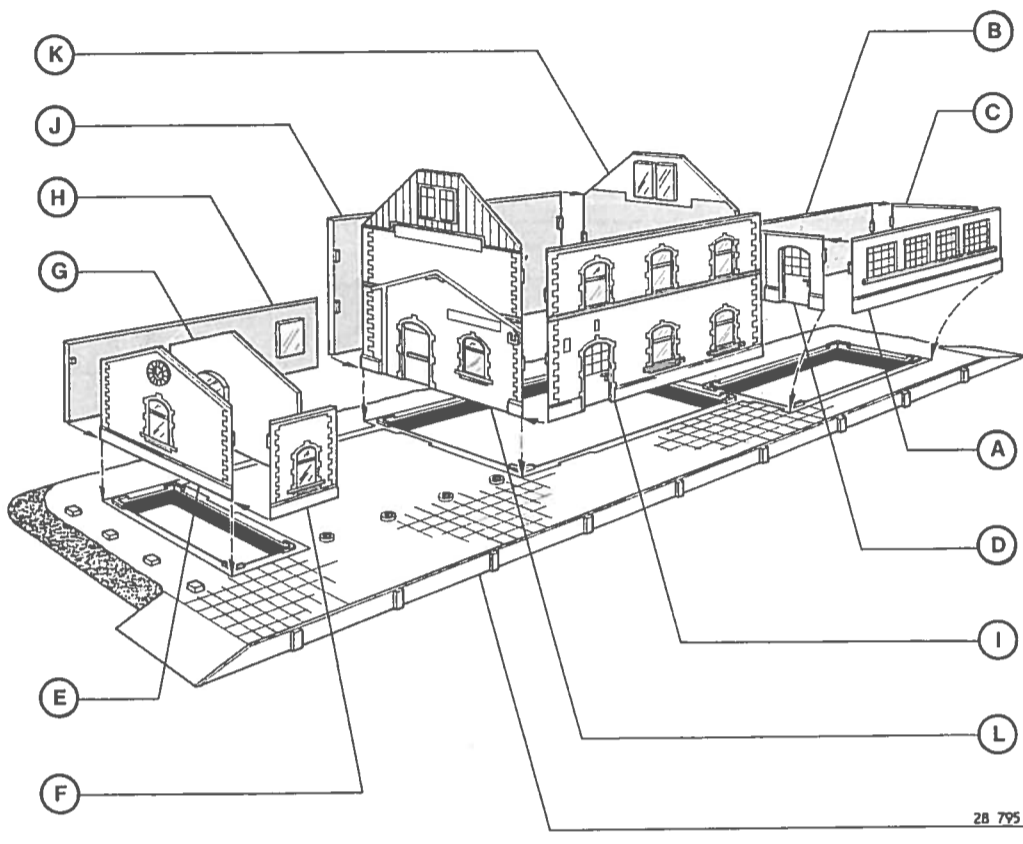
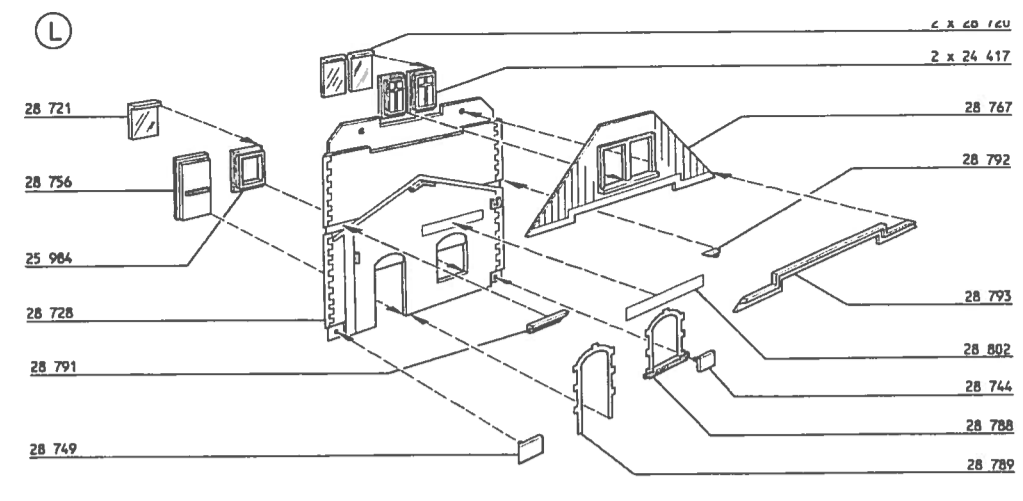

5

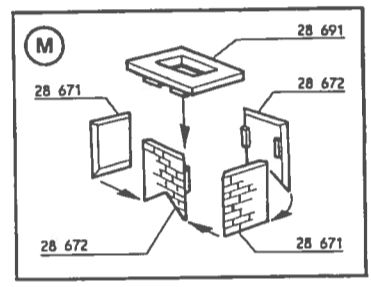
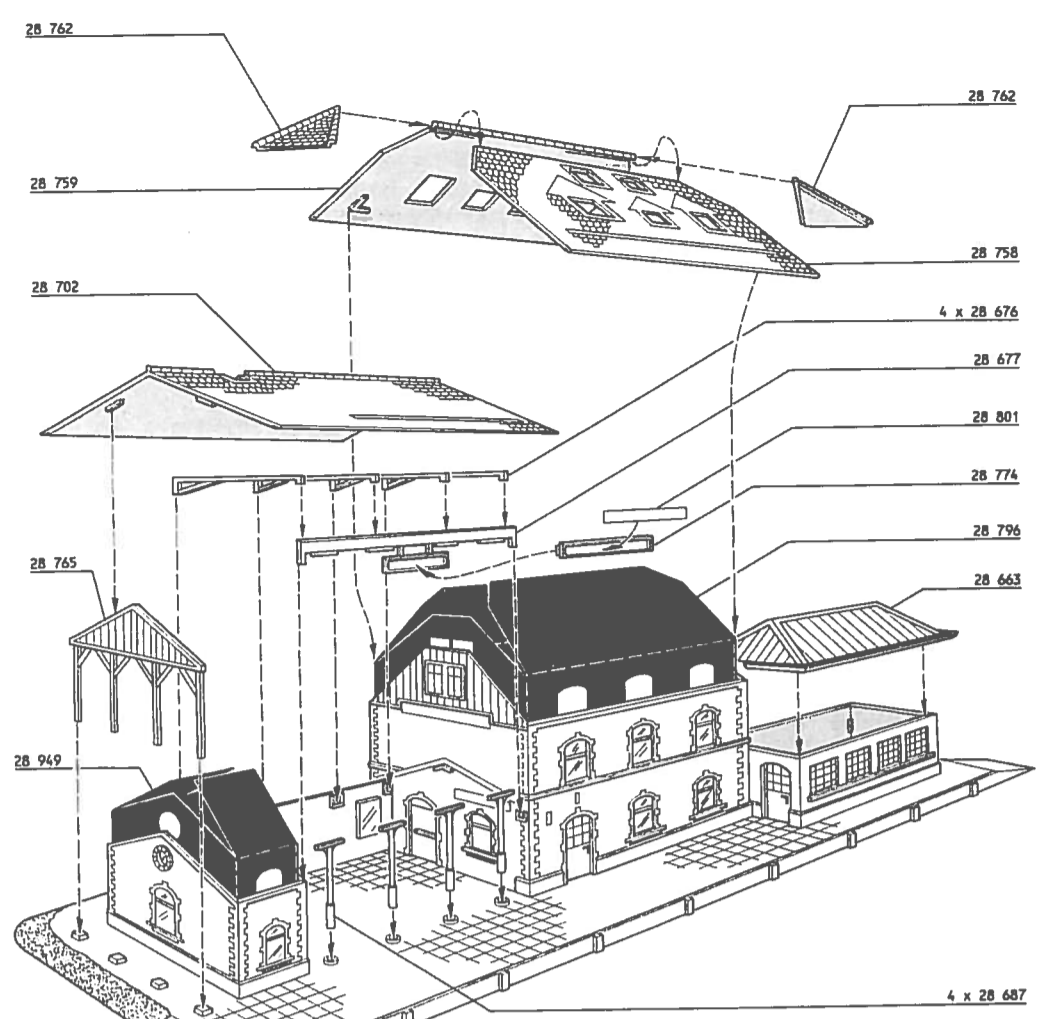

6

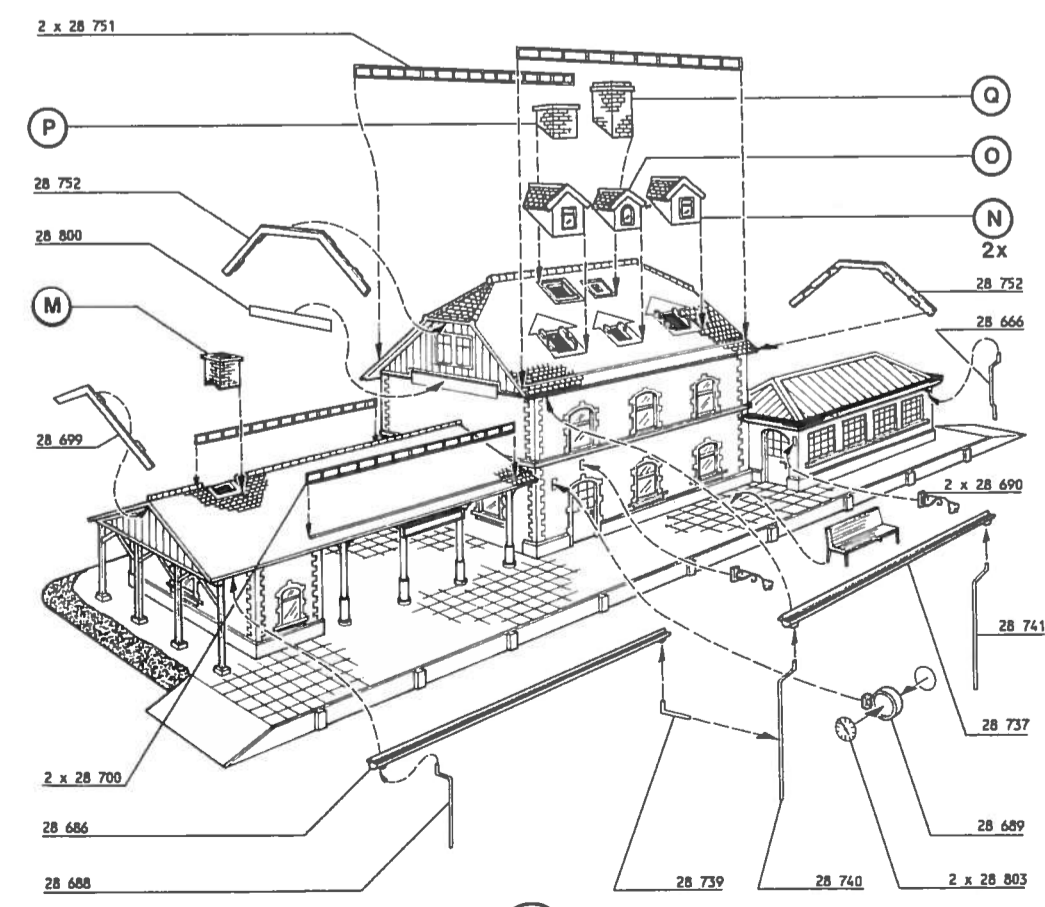
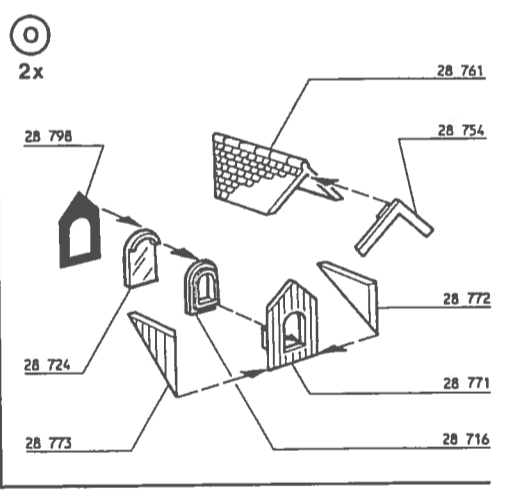
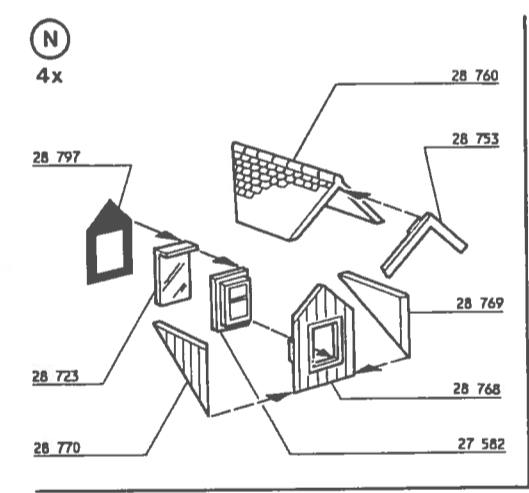
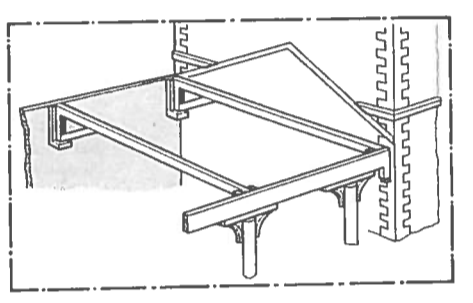

7

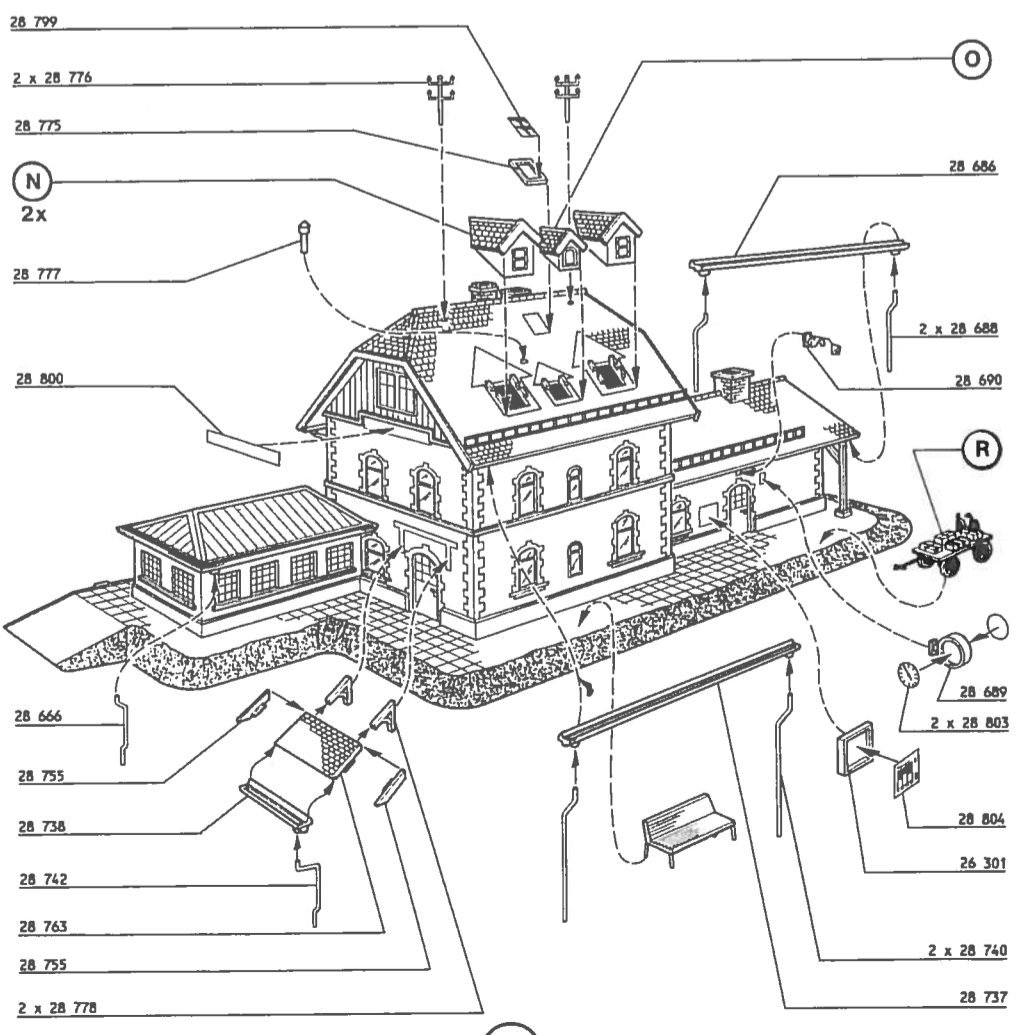
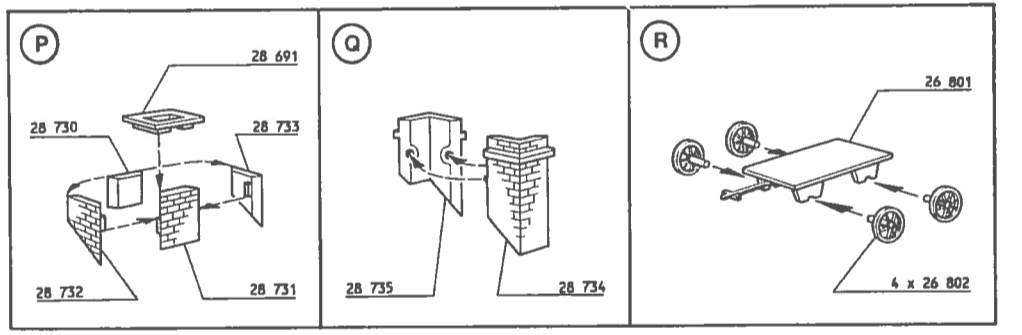

8