

61123 Sandwerk Beladebrücke / Loading Bridge

BAUANLEITUNG • INSTRUCTION • INSTRUCTION DE MONTAGE • BOUWBESCHRIJVING



D Mit dem Kauf dieses PIKO-Modells haben Sie ein präzises und leicht zusammenbaubares Gebäudemodell erworben. Um möglichst viel Spaß beim Bauen zu haben sollten Sie aber dennoch einiges beachten:

- Prüfen Sie den Bausatz auf Vollständigkeit. Sollte trotz sorgfältiger Prüfung durch PIKO ein Bauteil fehlen oder defekt sein, senden Sie diese Bauanleitung mit einem Vermerk zu dem fehlenden Einzelteil an uns. Sie erhalten dann kostenlos ein neues Teil. Bewahren Sie die Adresse auf.
- Die Einzelteile sind erst dann mit einem scharfen Messer vom Spritzling abzutrennen, wenn sie benötigt werden.
- Um ein sauberes Modell zu erhalten, benutzen Sie nur wenig handelsüblichen Plastikklebstoff.
- Entsorgen Sie die Plastikabfälle in die von den Städten und Gemeinden bereitgestellten Kunststoff-Sammelbehälter.

PIKO kennzeichnet seine Spritzlinge mit dem Recycling-Schrittstempel. Daraus ist zu erkennen, das PIKO seine Bauteile aus Polystyrol (PS) unter der Codierung 06 herstellt. Der Kunststoff wird nach DIN 6120 eingeordnet.

GB In buying this PIKO model you have acquired a precisely fitting building model which is easy to assemble. To make sure that you enjoy your model to the full, we make the following recommendations:

- Check that the kit is complete. If despite all the care taken by PIKO a part should be missing or faulty, please send us this sheet of instructions with a note of the missing part. You will then receive a replacement part free of charge. Please keep the address.
- Use a sharp knife to detach each part from the moulding immediately before you need it.
- Use small amounts of one of the plastic glues on the market to ensure that the final model has a clean appearance.

F Avec l'achat de cette maquette PIKO, vous avez acquis un bâtiment miniature fidèle et facile à monter. Pour avoir si possible beaucoup de plaisir au montage, vous devez cependant faire attention à:

- Vérifiez la composition de la construction dans son intégralité. S'il devait, malgré la vérification de PIKO, manquer une pièce ou y avoir un défaut, envoyez-nous cette instruction de montage

avec une mention de la pièce manquante. Vous obtiendrez alors sans frais une nouvelle pièce. Gardez bien l'adresse.

- Les pièces sont séparées avec un couteau aiguisé si nécessaire.
- Pour obtenir une maquette propre, utilisez seulement en petite quantité de la colle plastique d'usage.

NL Met de koop van dit PIKO model heeft U een pasklaar en makkelijk in elkaar te zetten bouwmodel. Om zoveel mogelijk plezier te hebben bij het opbouwen moet U het volgende in acht nemen:

- Kijk U na of de bouwset compleet is. Mocht ondanks zorgvuldige controle door PIKO toch een onderdeel ontbreken of defekt zijn, stuurt U dan deze gebruiksaanwijzing met een aantekening welk onderdeel het betreft naar ons op. U ontvangt dan kosteloos een nieuw onderdeel. Bewaar U wel het adres.
- De individuele onderdelen moet U losmaken met een scherp mes, echter pas als U ze nodig hebt.
- Om een schoon model te krijgen, hoeft U slechts een weinig plaklijm te gebruiken.

PIKO Modellspielwaren GmbH • Lutherstraße 30 • 96505 Sonneberg • Telefon (0 36 75) 89 72 - 0 • Fax (0 36 75) 89 72 50

61123-90-7000

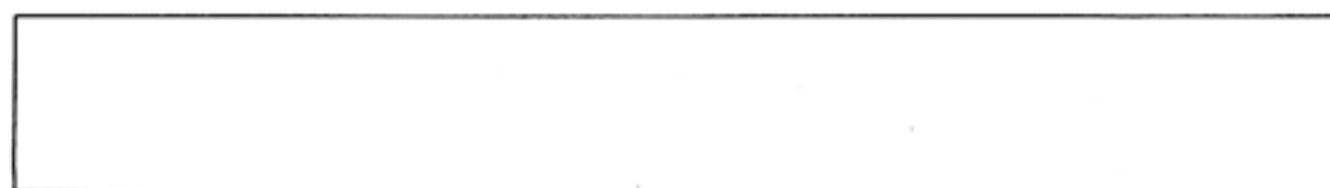

2x61101-0121.53

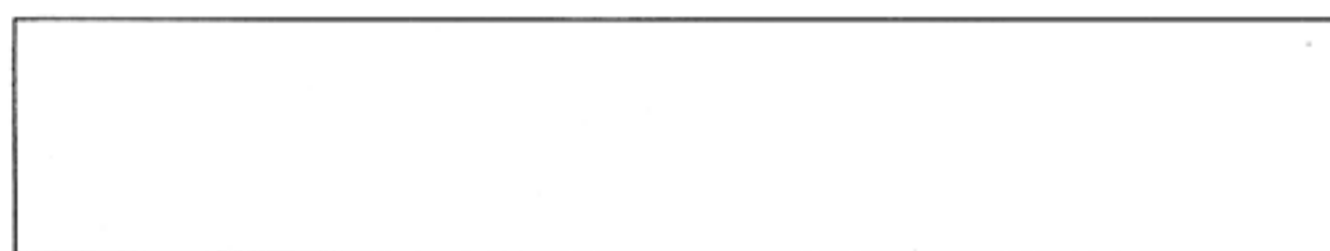

2x61101-0122.53

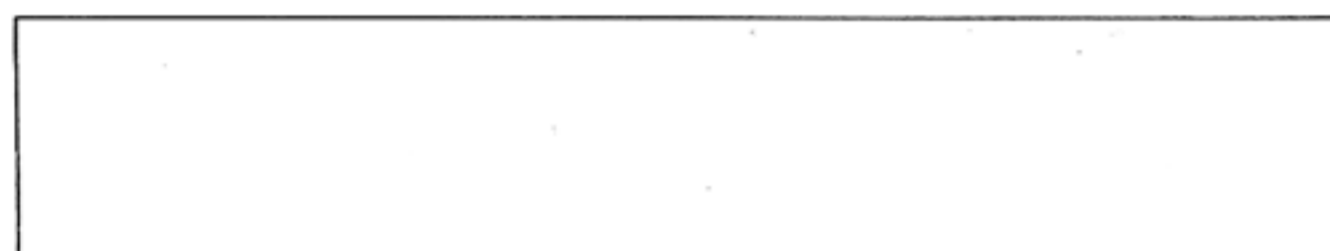

2x61101-0123.53



4x61101-0124.53



2x61123-0121.50



2x61123-0122.50



4x61123-0124.50

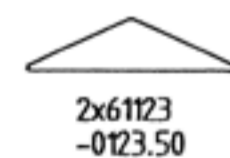

2x61123-0123.50

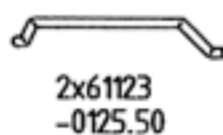

2x61123-0125.50

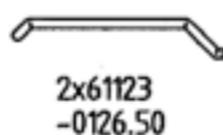

2x61123-0126.50

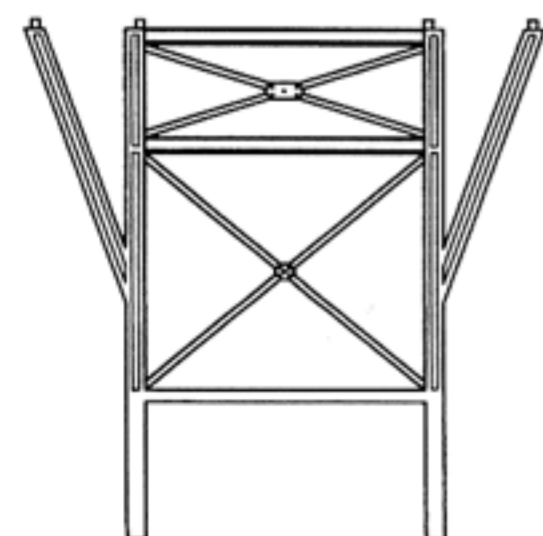

4x61123-0321.50

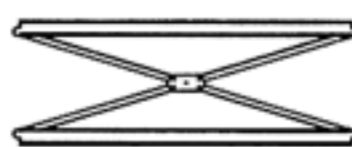

6x61123-0322.50

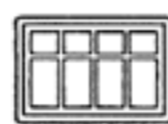

12x61123-0323.50



8x61123-0324.50



2x61123-0325.50



2x61123-0326.50



12x61123-0327.50

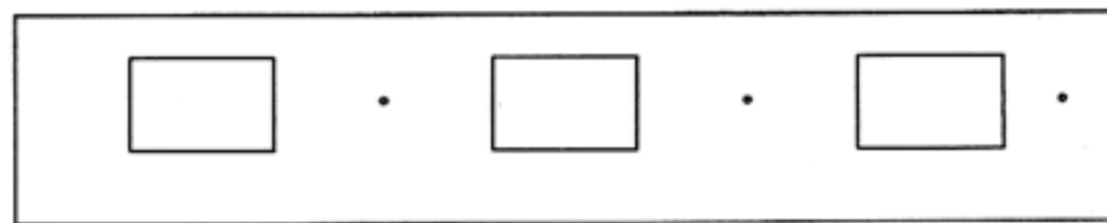

4x61113-0221.52

2x61113-0223.52



6x61113-0224.52



2x61113-0225.52



2x61113-0226.52

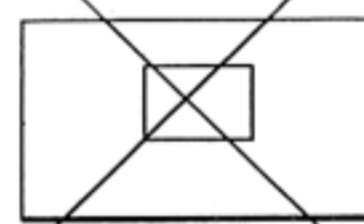

2x61113-0227.52

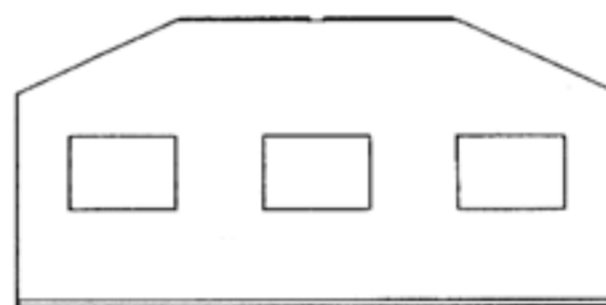

2x61113-0229.52



2x61113-0231.52

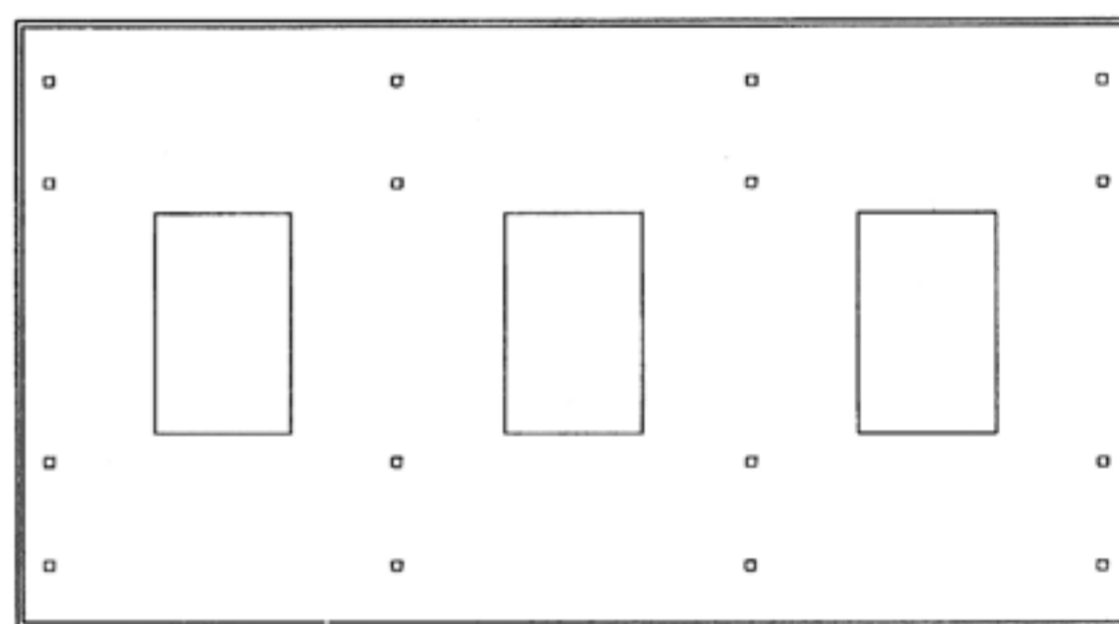

61123-0221.50



3x61123-0421.50

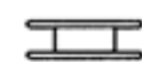

3x61123-0422.50



3x61123-0424.50

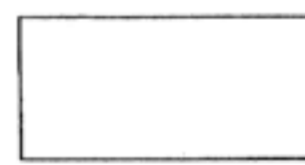

4x61114-0529.50

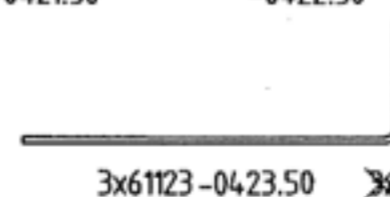

3x61123-0423.50



2x61123-0425.50



2x61114-0530.50



99999-83-2000

1 2x

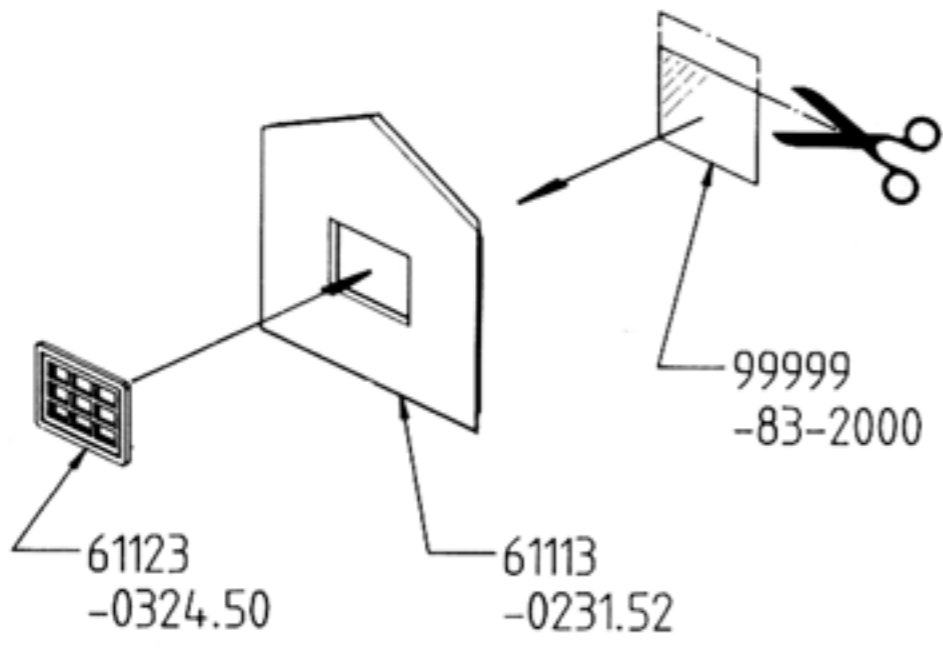

2 2x

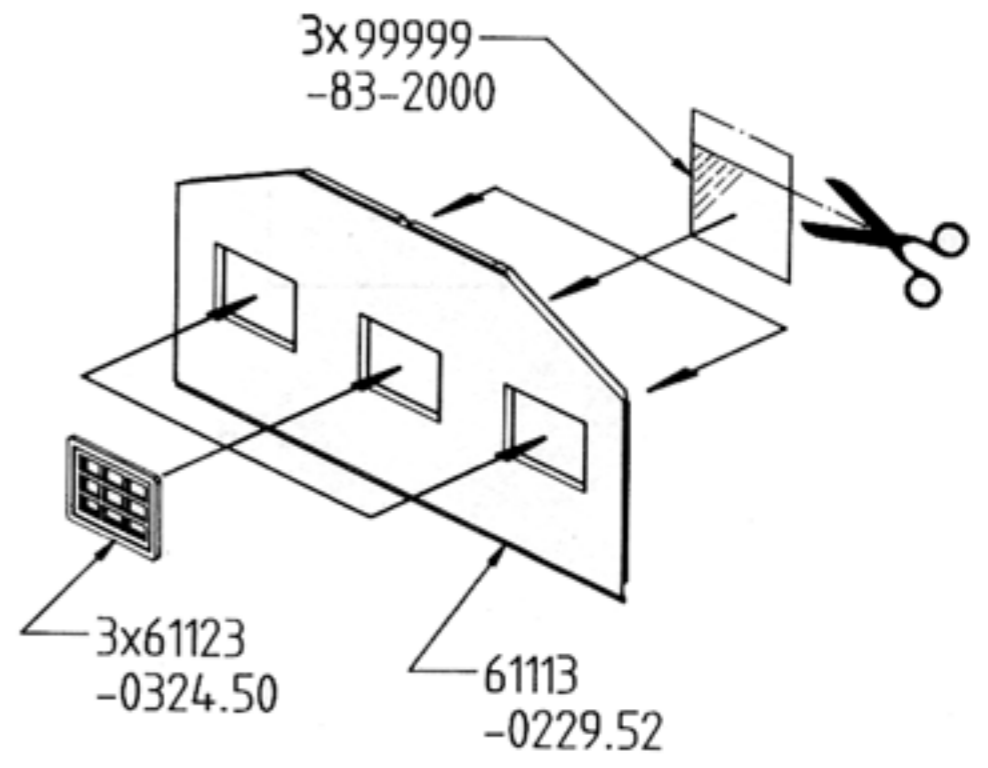

3 4x

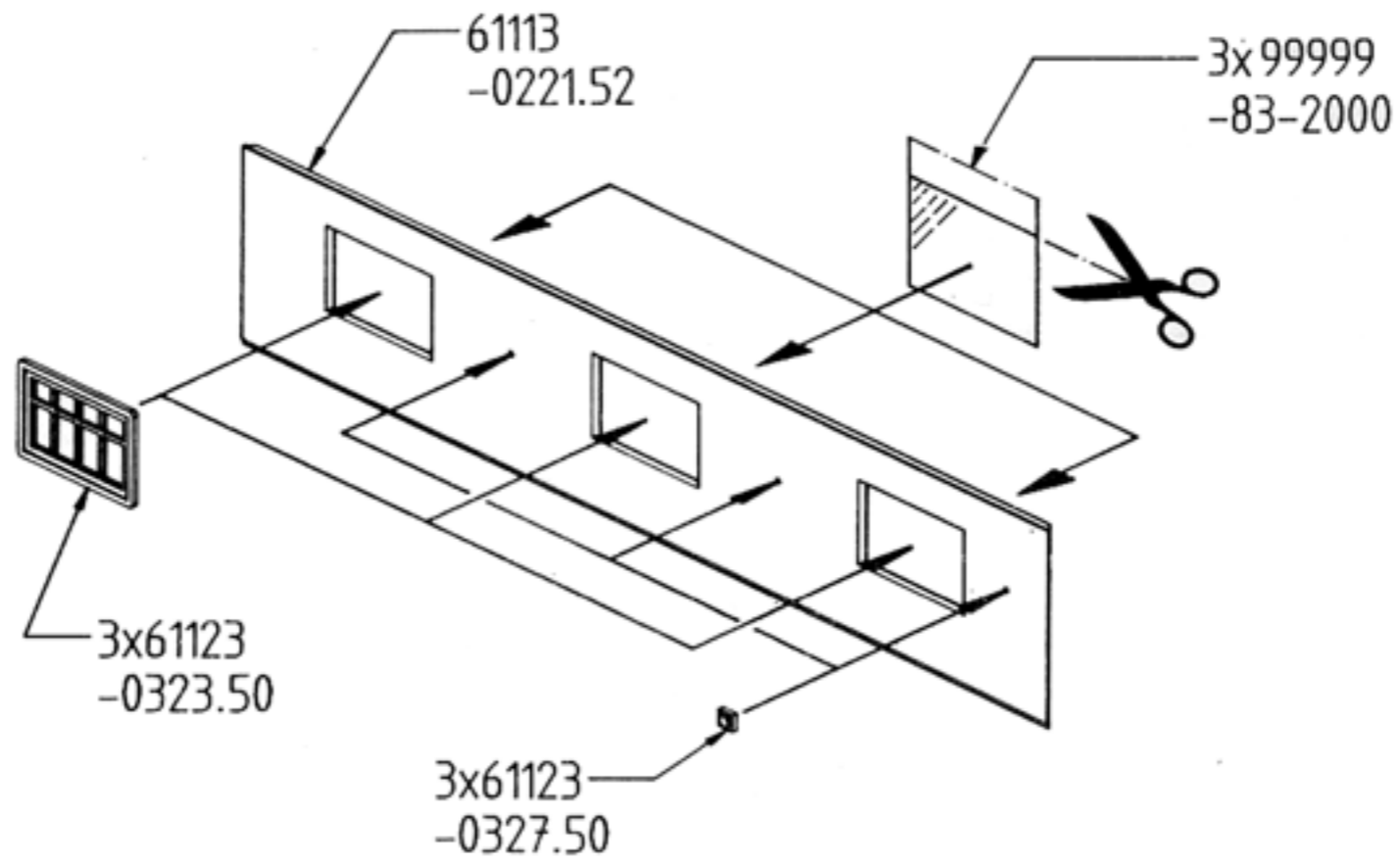

4

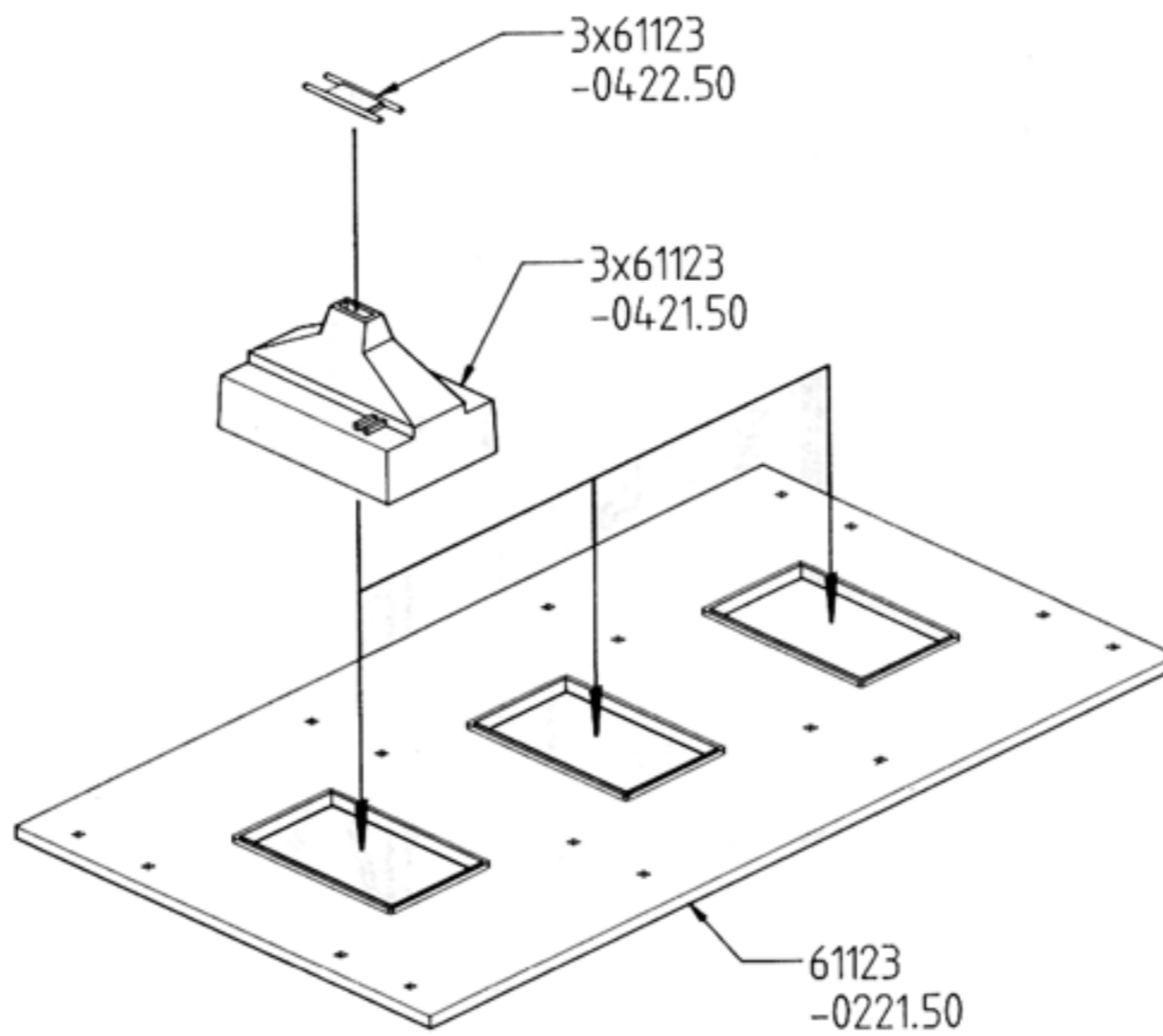

5 4X

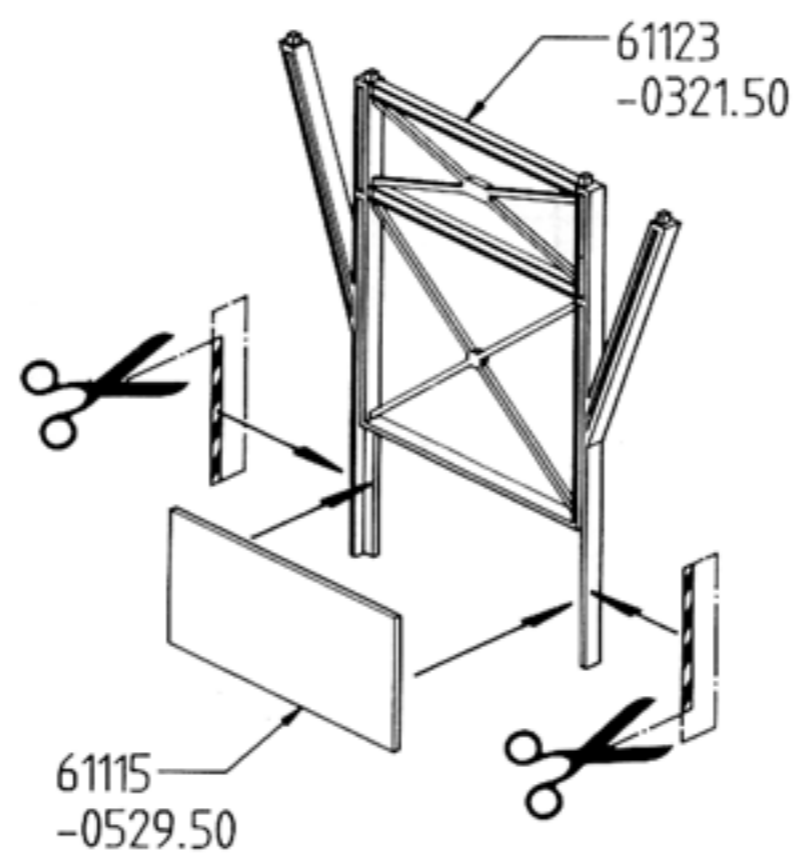

6

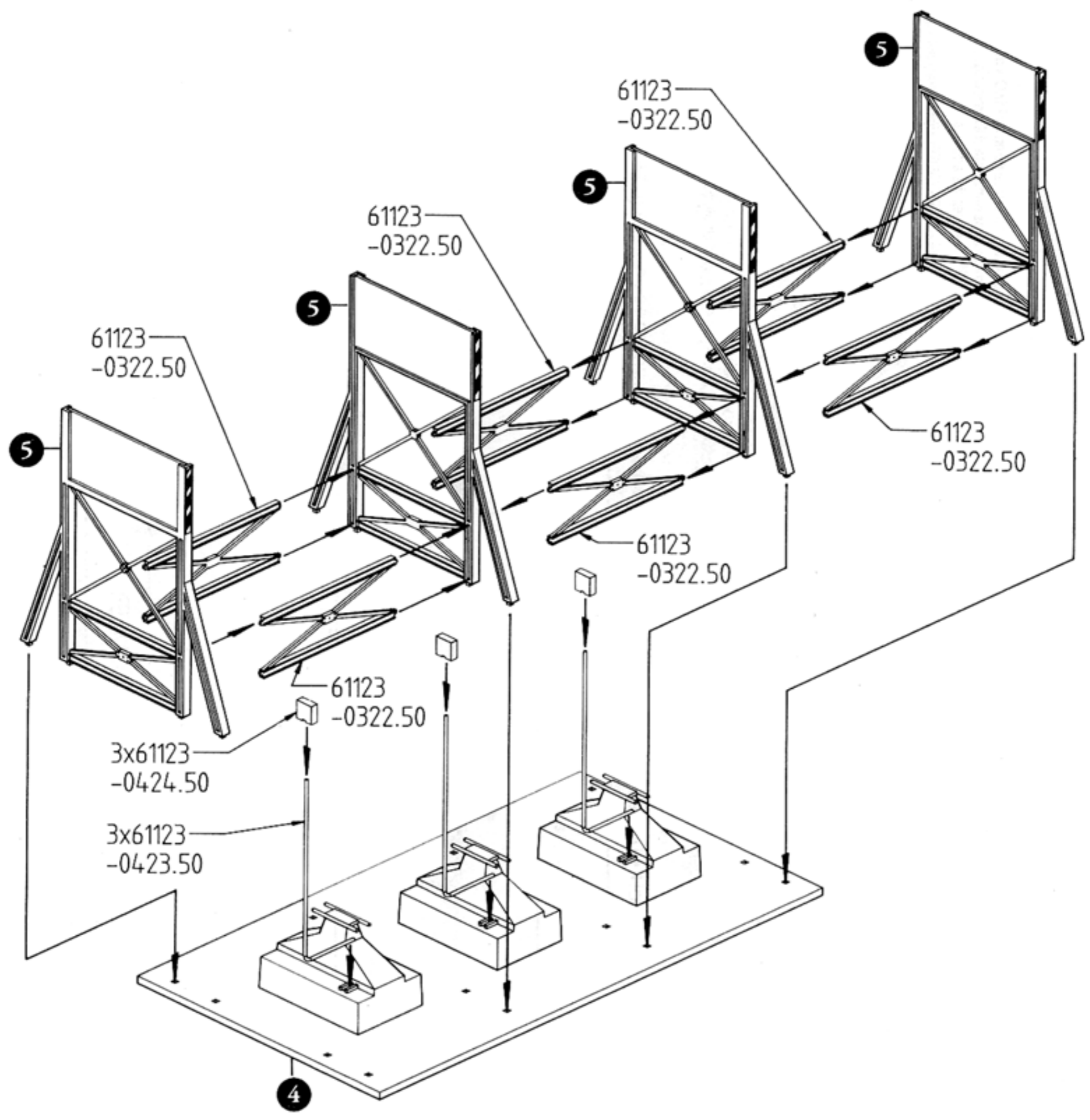

7

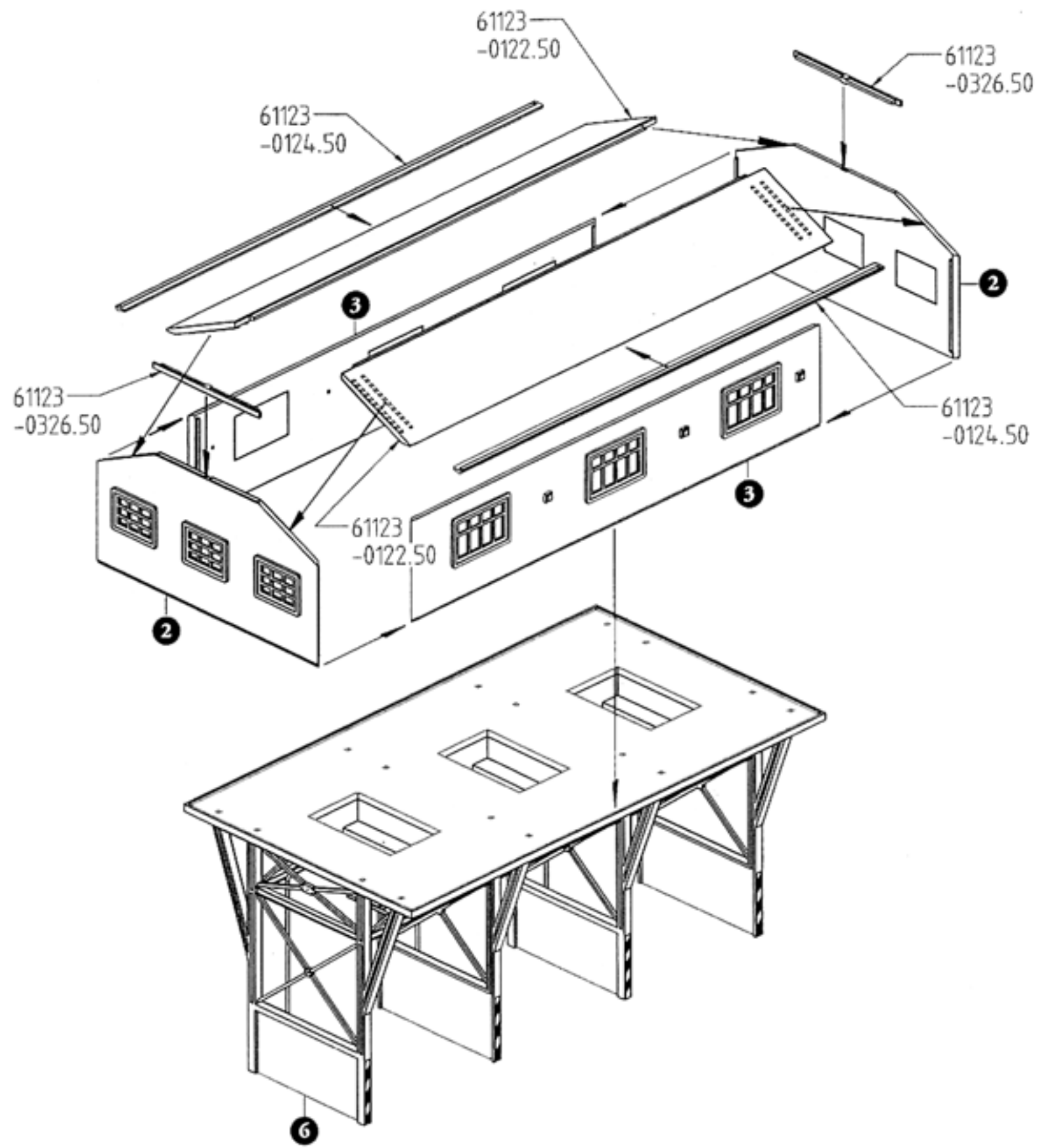

8

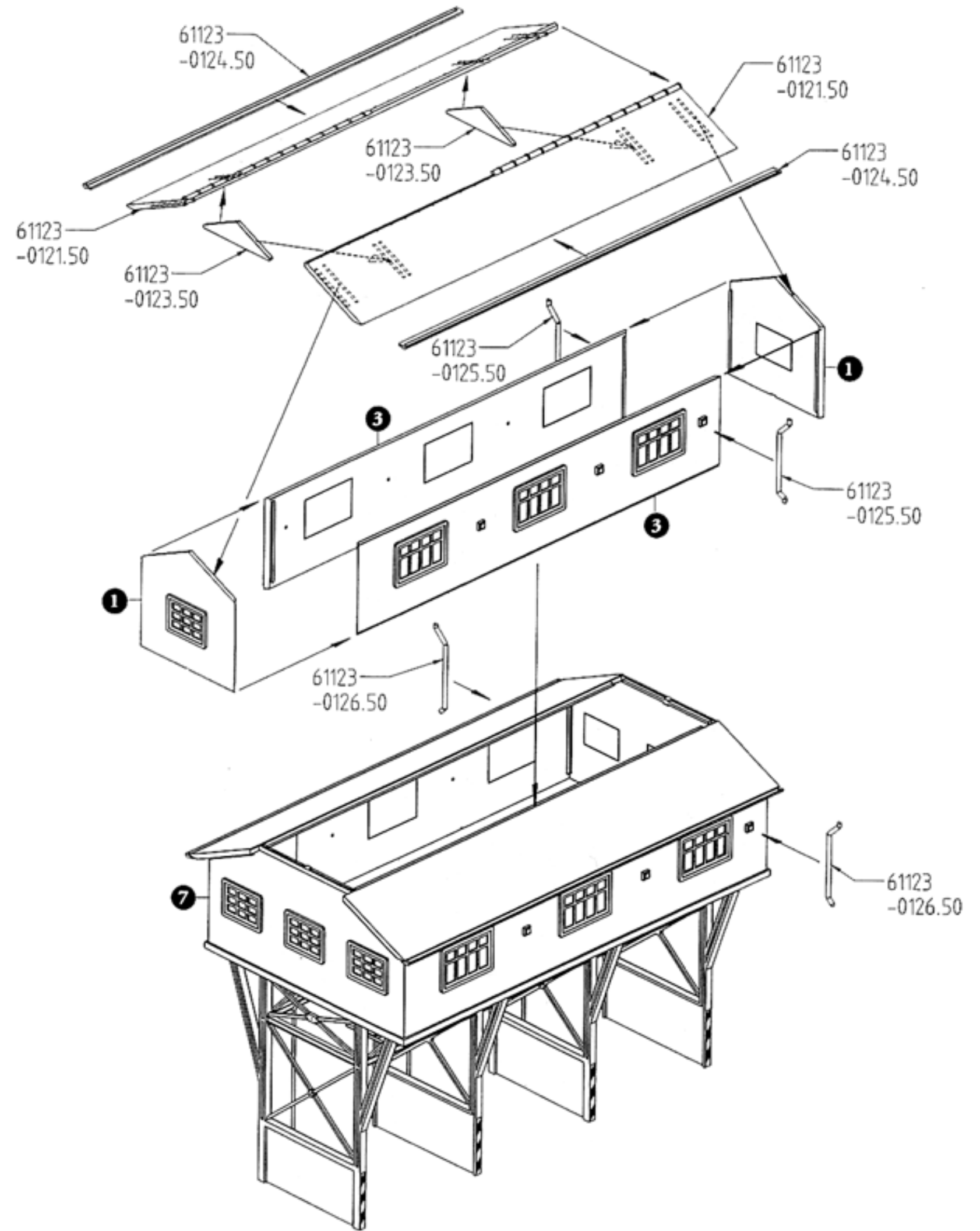

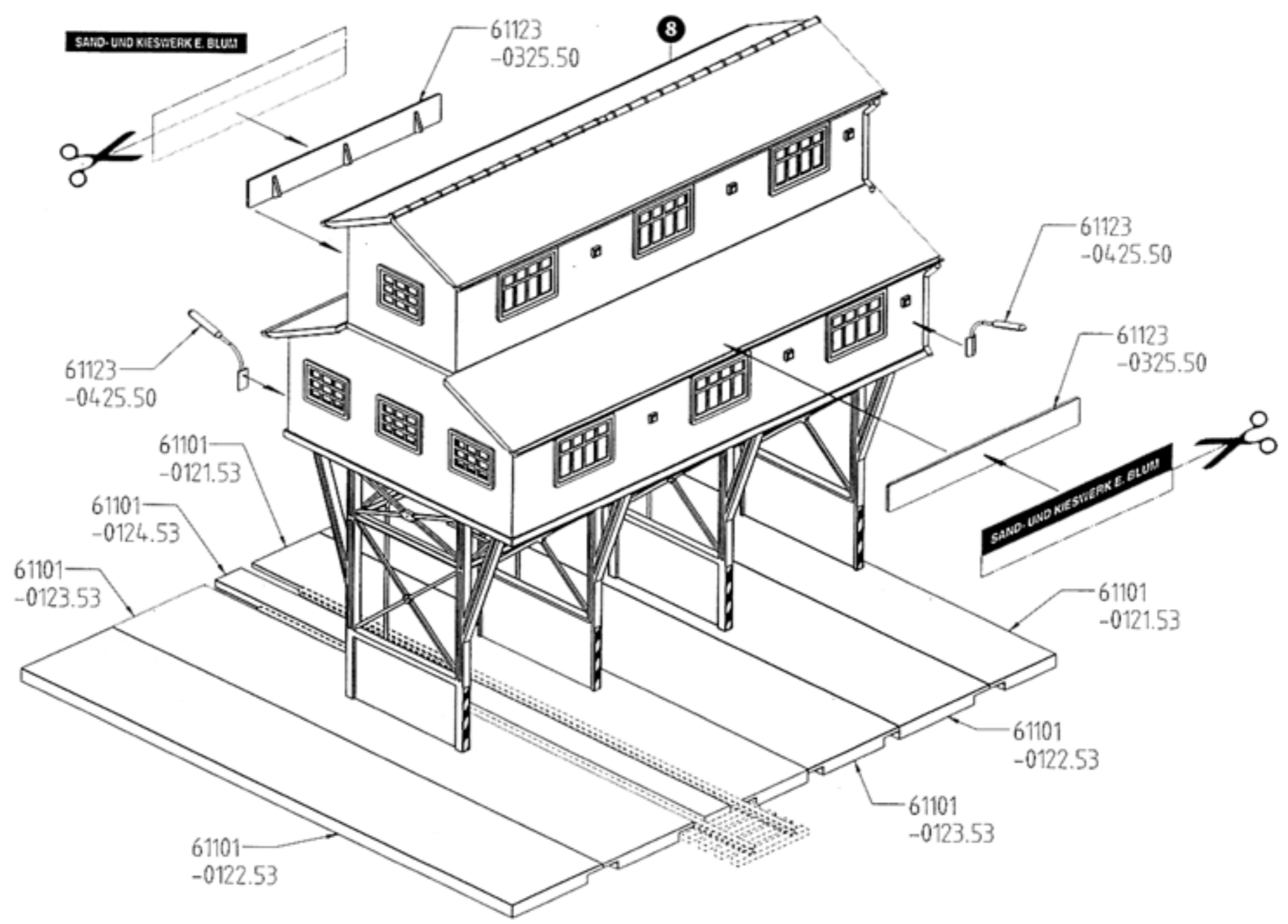

PIKO Art.-Nr. 61124

