



... wie im Original

63800 Bergrestaurant "Grosser Mythen" N

Mountain Restaurant "Grosser Mythen" N

L'auberge de montagne "Grosser Mythen" N

Restaurante de Montaña "Grosser Mythen" N

Bergrestaurant "Grosser Mythen" N



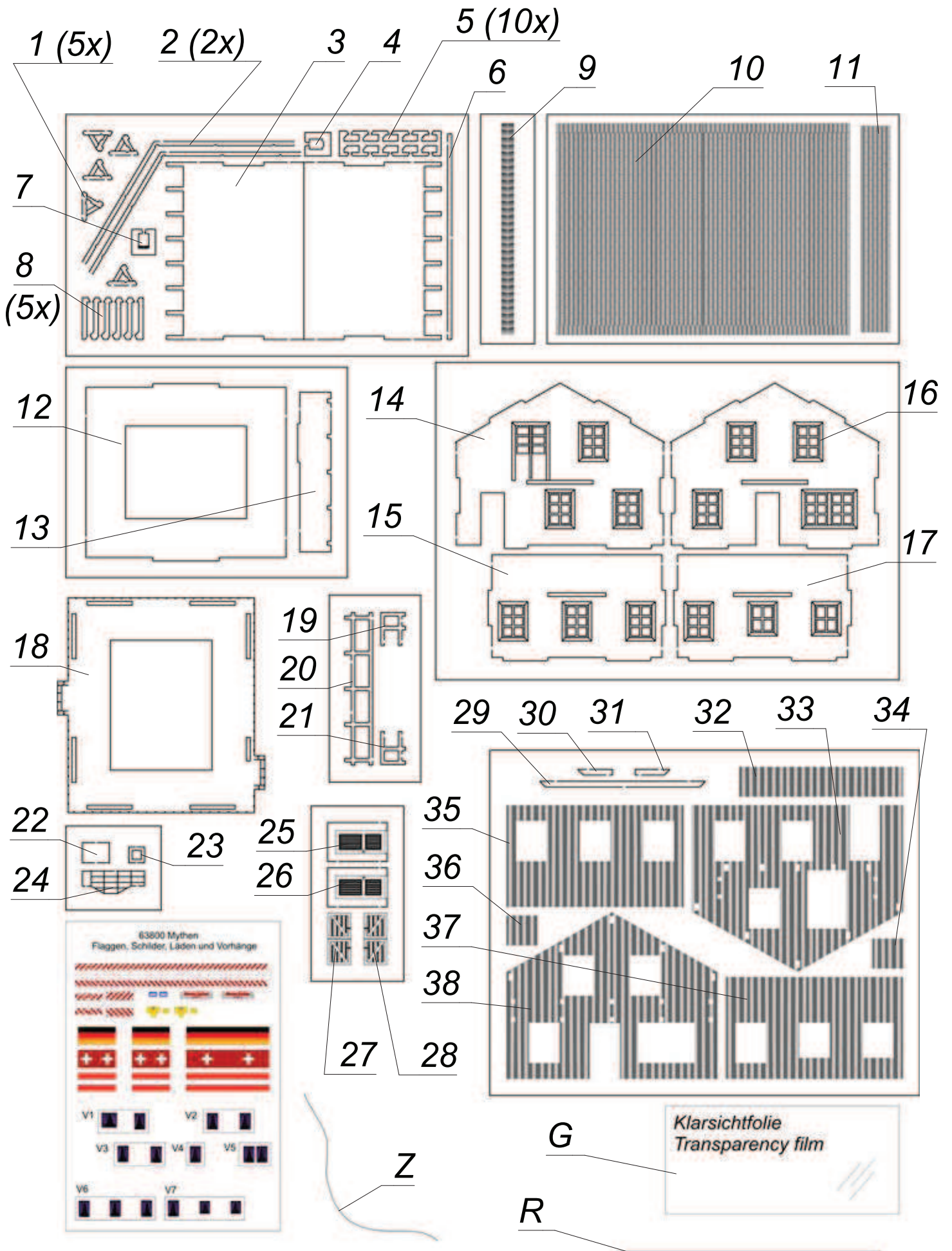

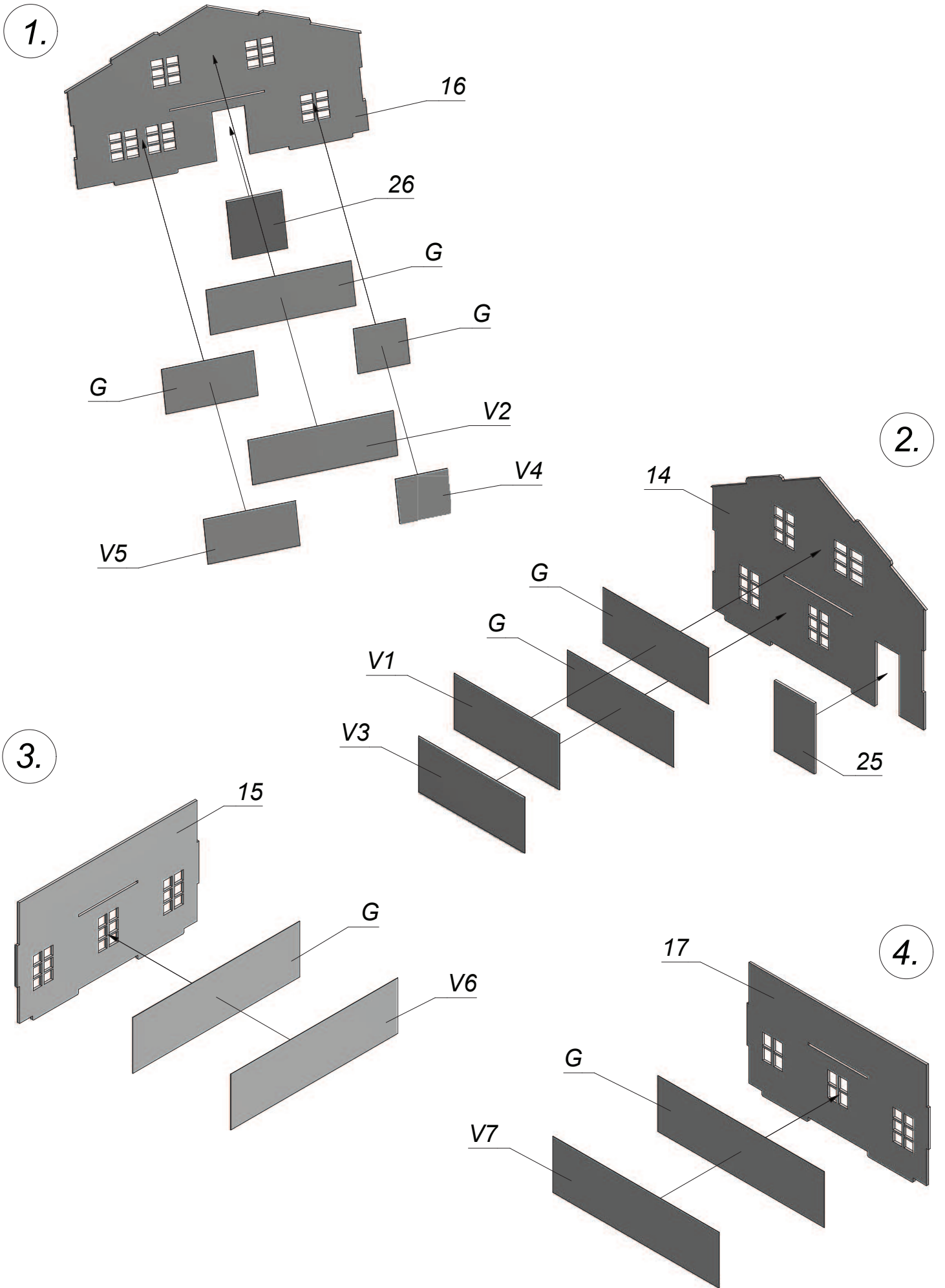

5.

Achtung!
Teil 15 und 17 richtig ausrichten! Sie sind **nicht** formgleich (Fenster).

Attention!
Add parts 15 and 17 in the correct position! They are **different** (windows).

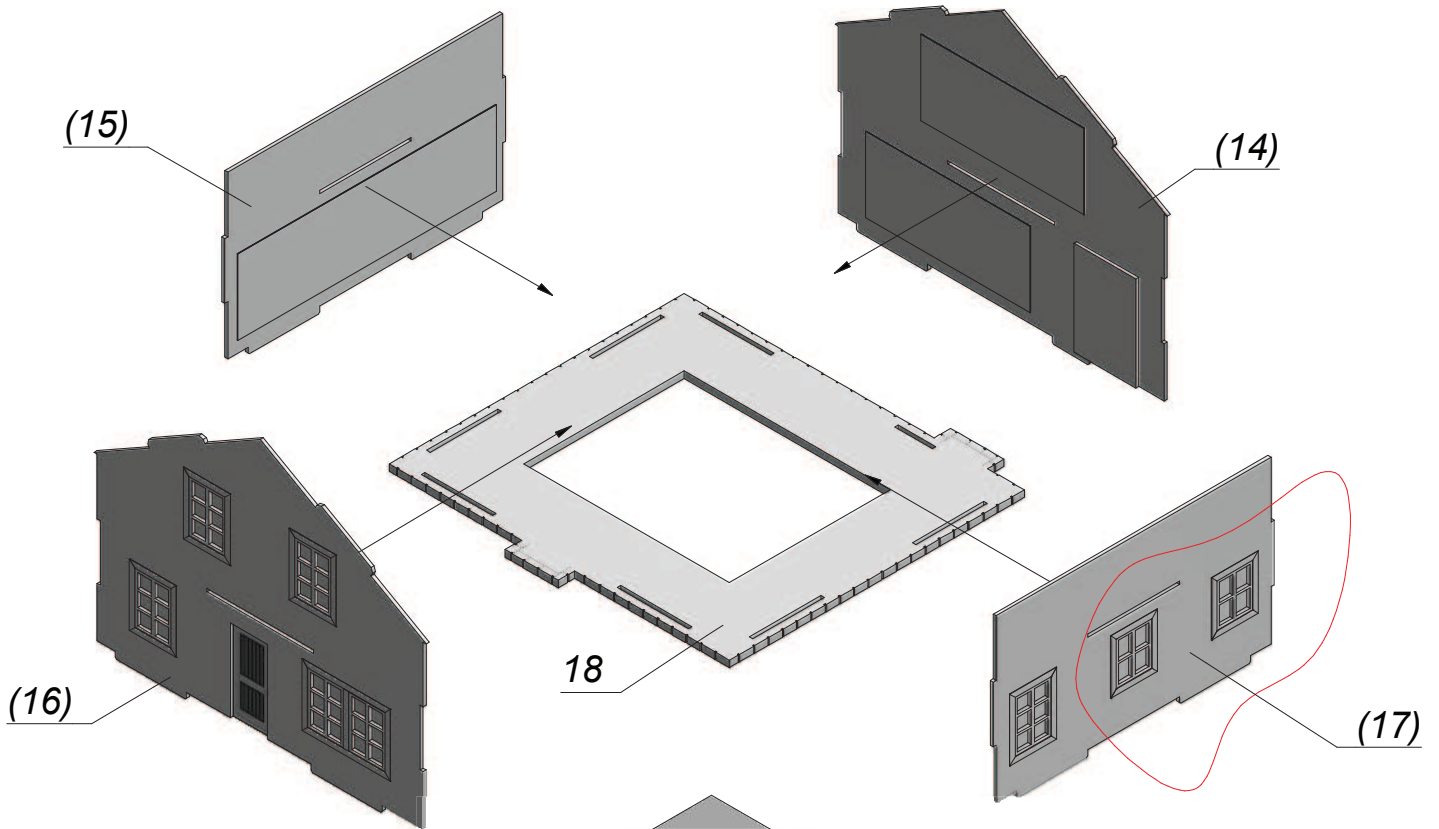

6.

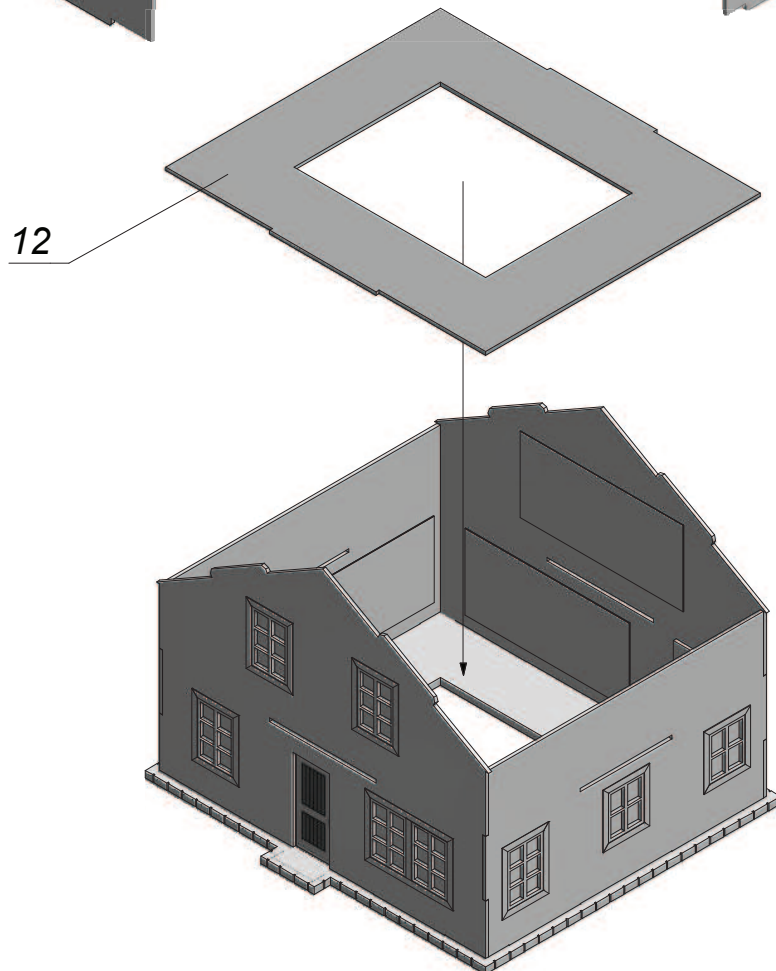

7.

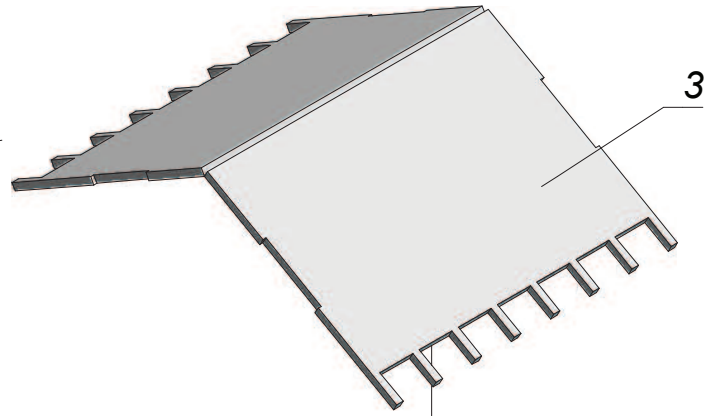

3

8.

Achtung!
Teil 35 und 37 richtig ausrichten!
Sie sind **nicht** formgleich (Fenster).

Attention!
Add parts 35 and 37 in the correct
position! They are **different** (windows).

**Kleber auf die Teile 33, 35,
37 und 38 aufbringen.**

Add glue to the parts 33, 35, 37 and 38!

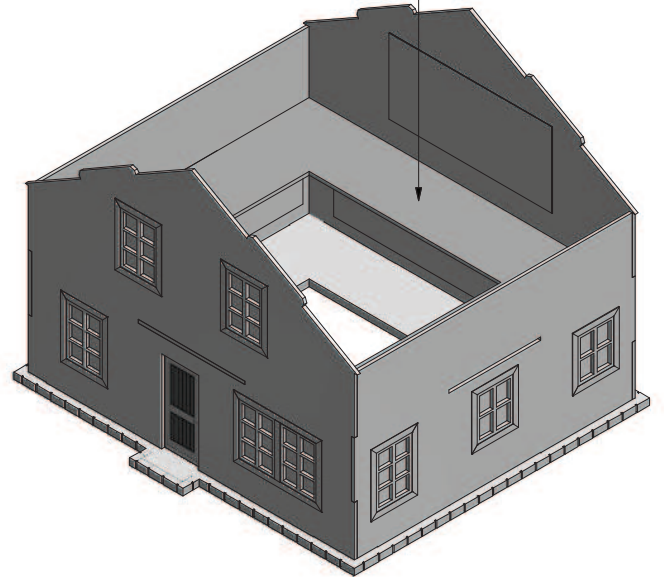

35

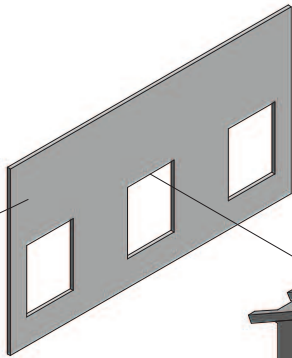

33

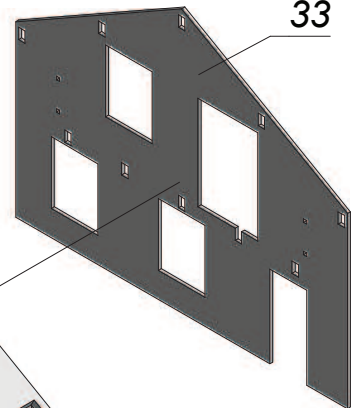

38

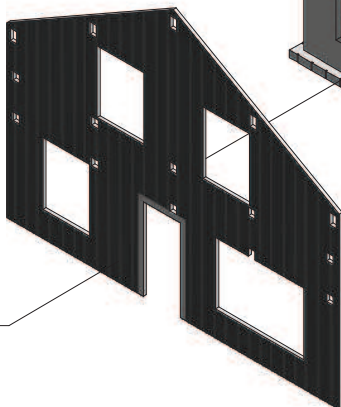

37

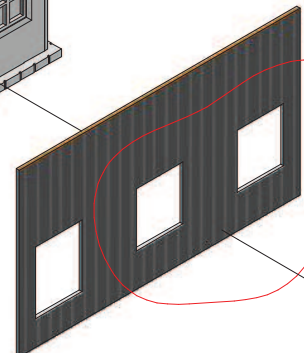

9.

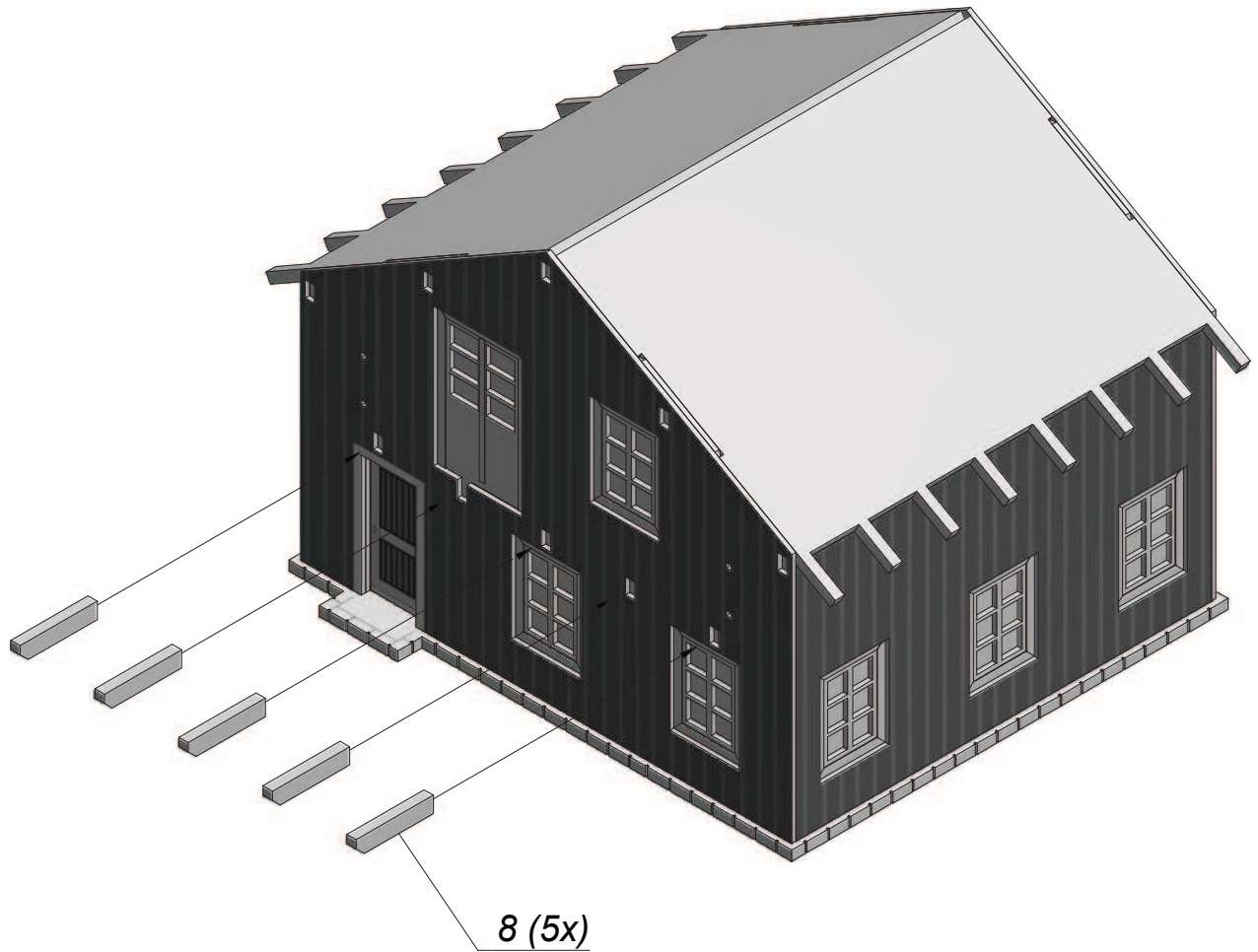

10.

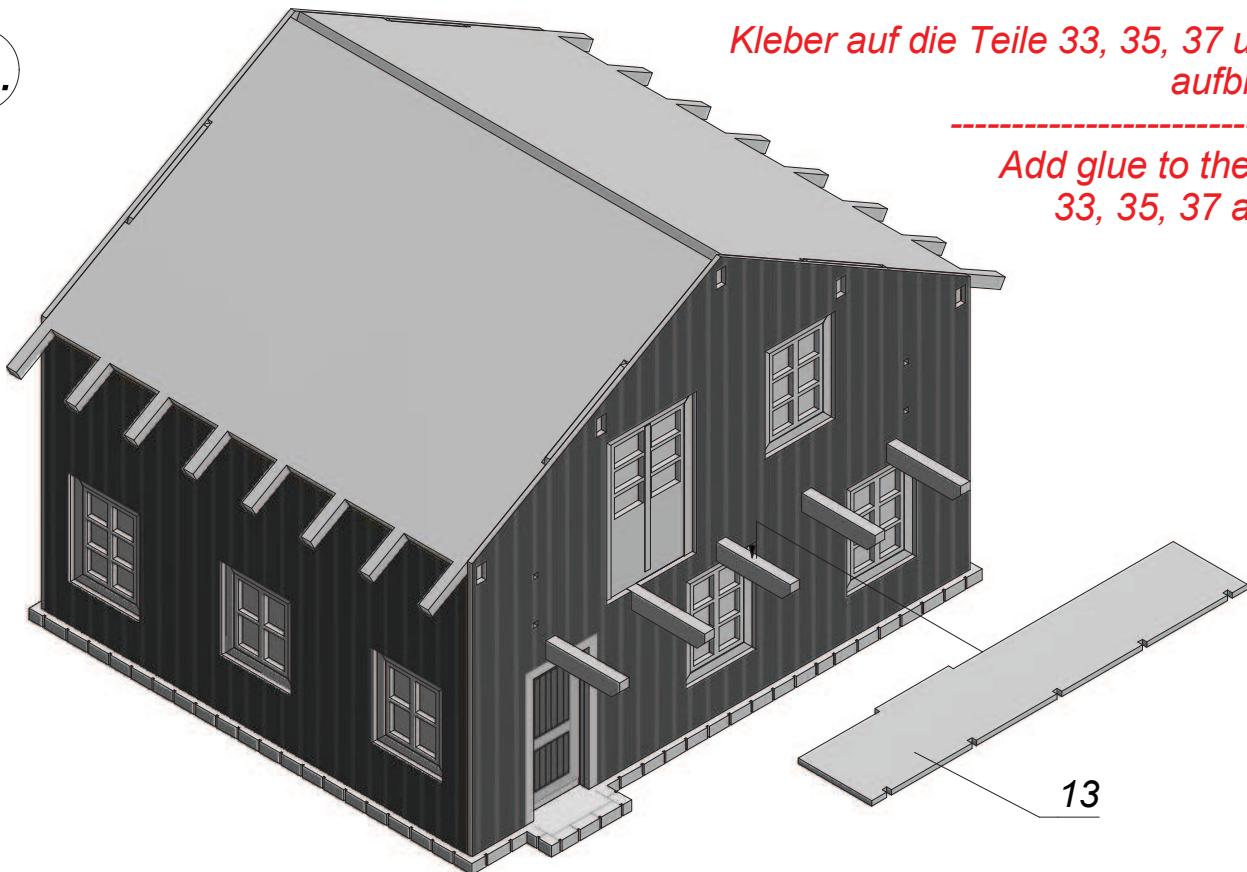

Kleber auf die Teile 33, 35, 37 und 38 aufbringen.

Add glue to the parts 33, 35, 37 and 38!

11.



FL1 (2x): 13 mm x 4 mm

FL2 (4x): 6,5 mm x 3 mm

FL3 (24x): 8 mm x 3 mm

12.

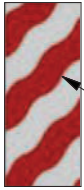

Auf richtige Ausrichtung achten!

Pay attention to correct position!

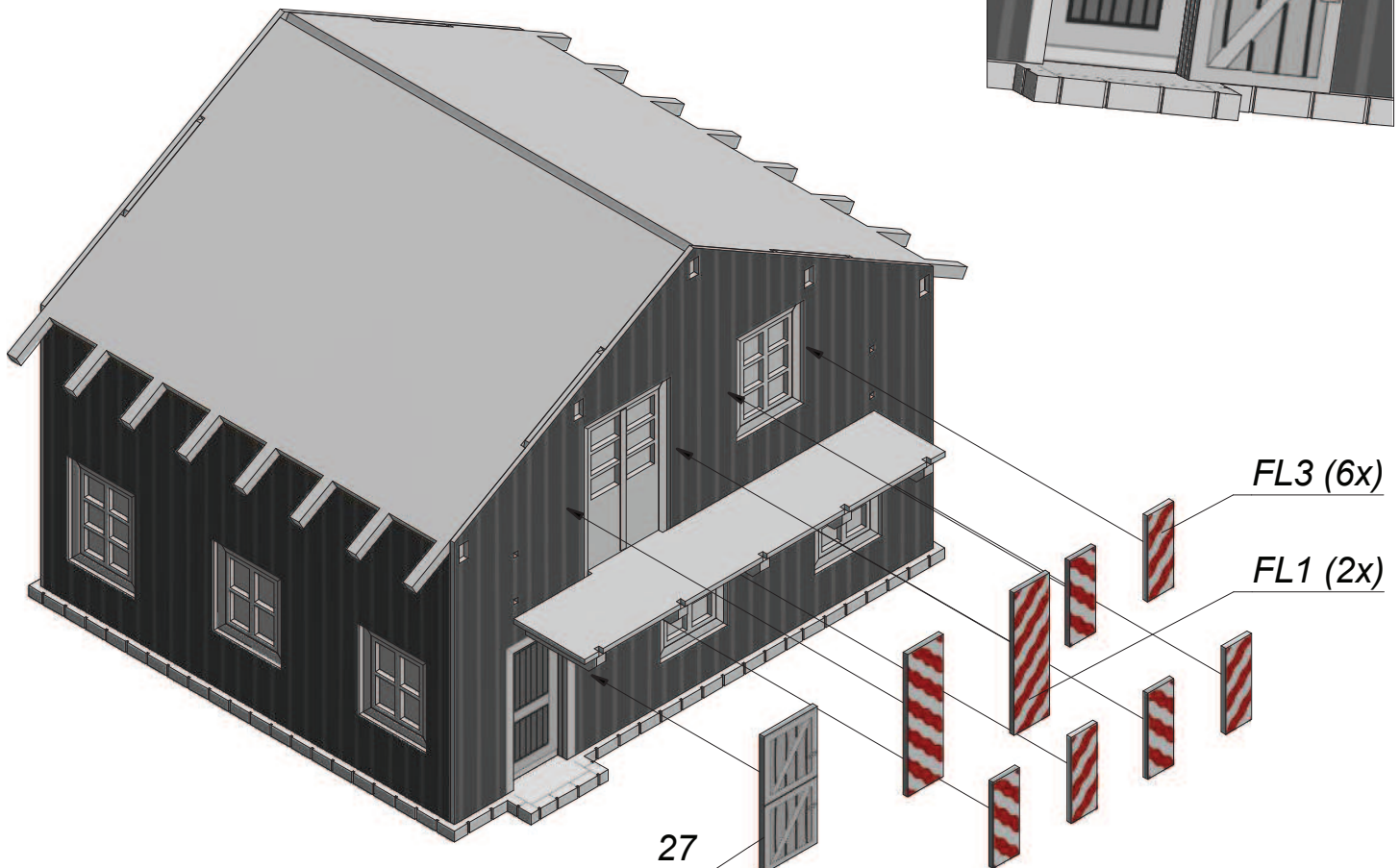
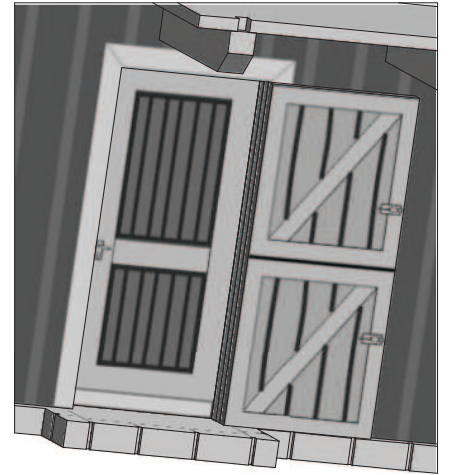

13.

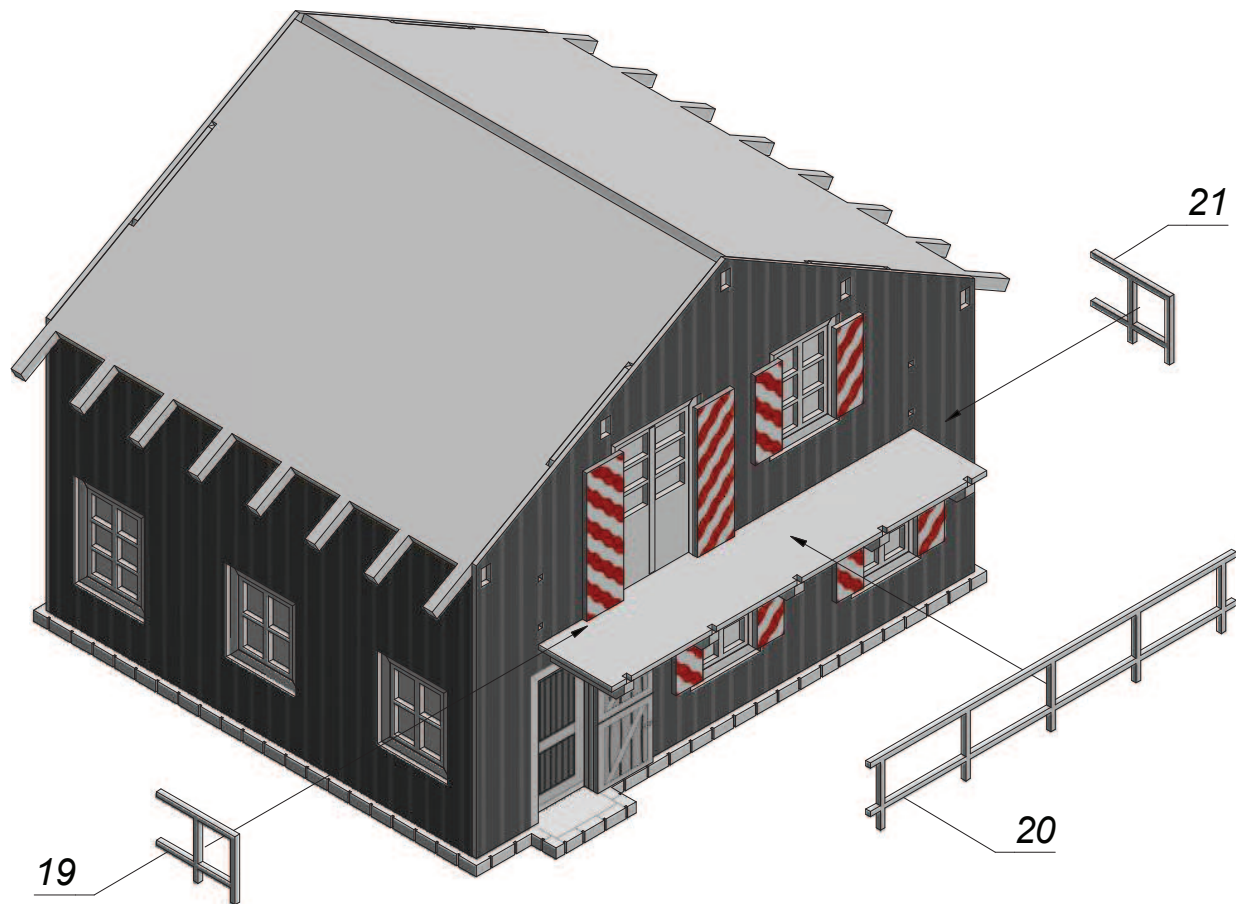

14.

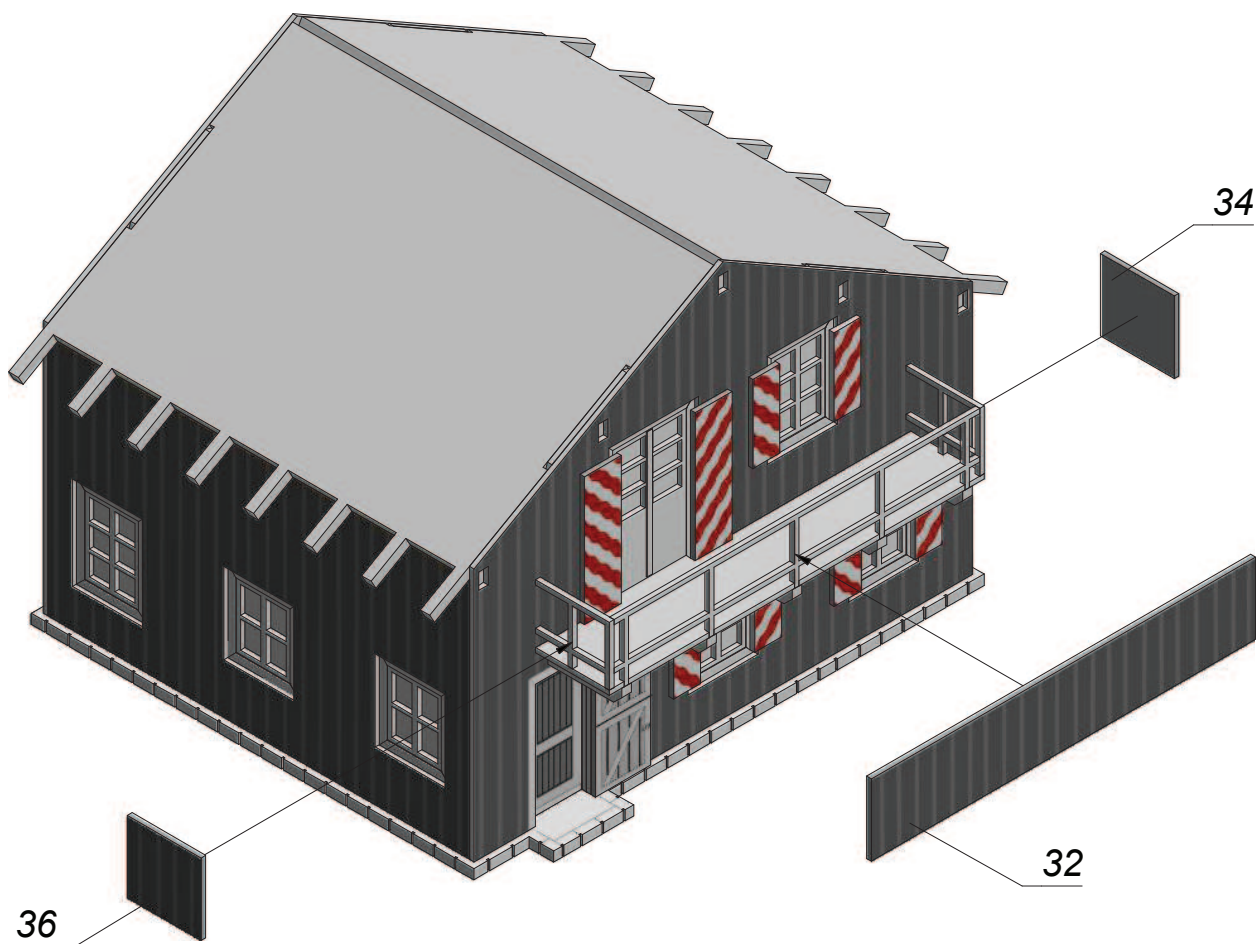

15.

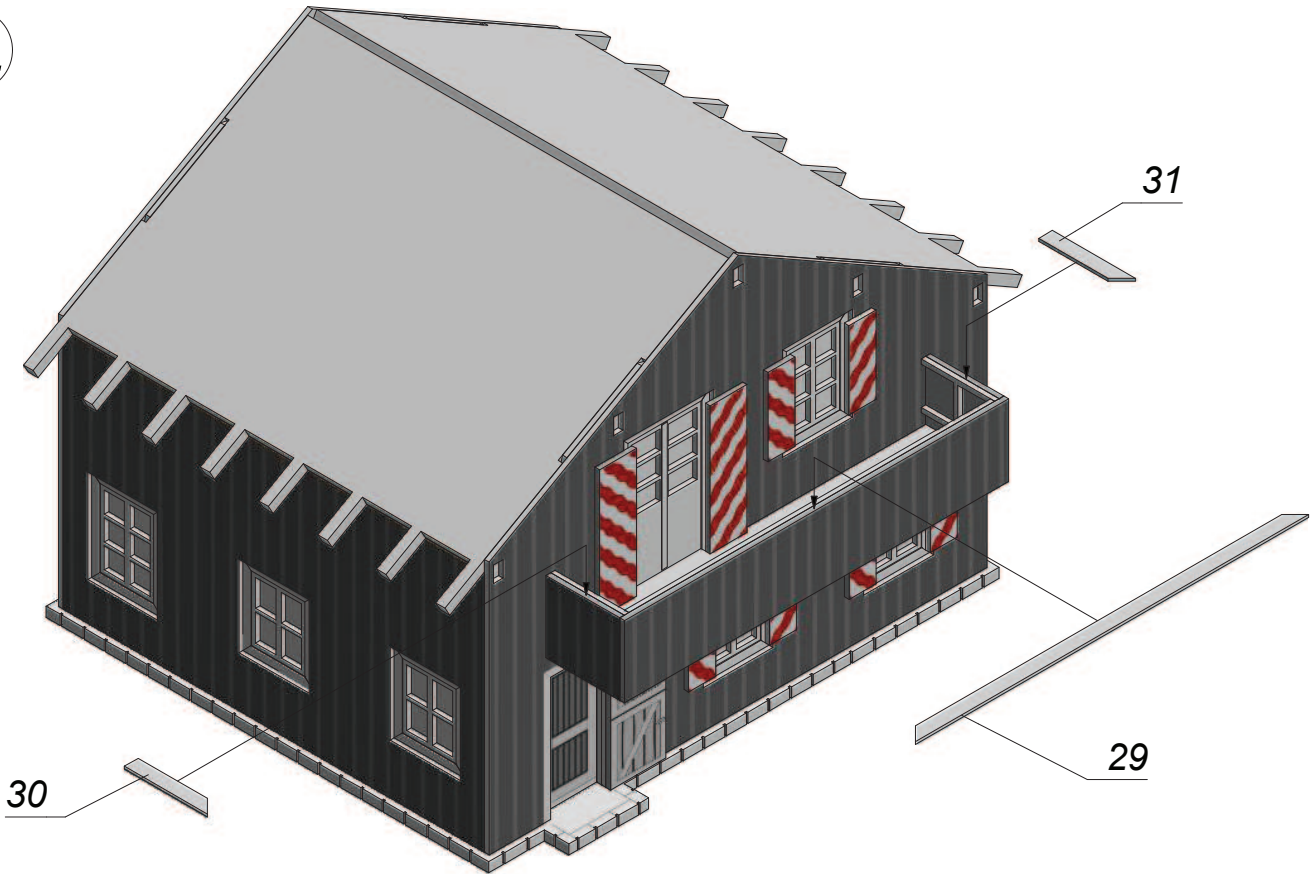

16.

FL3 (6x)

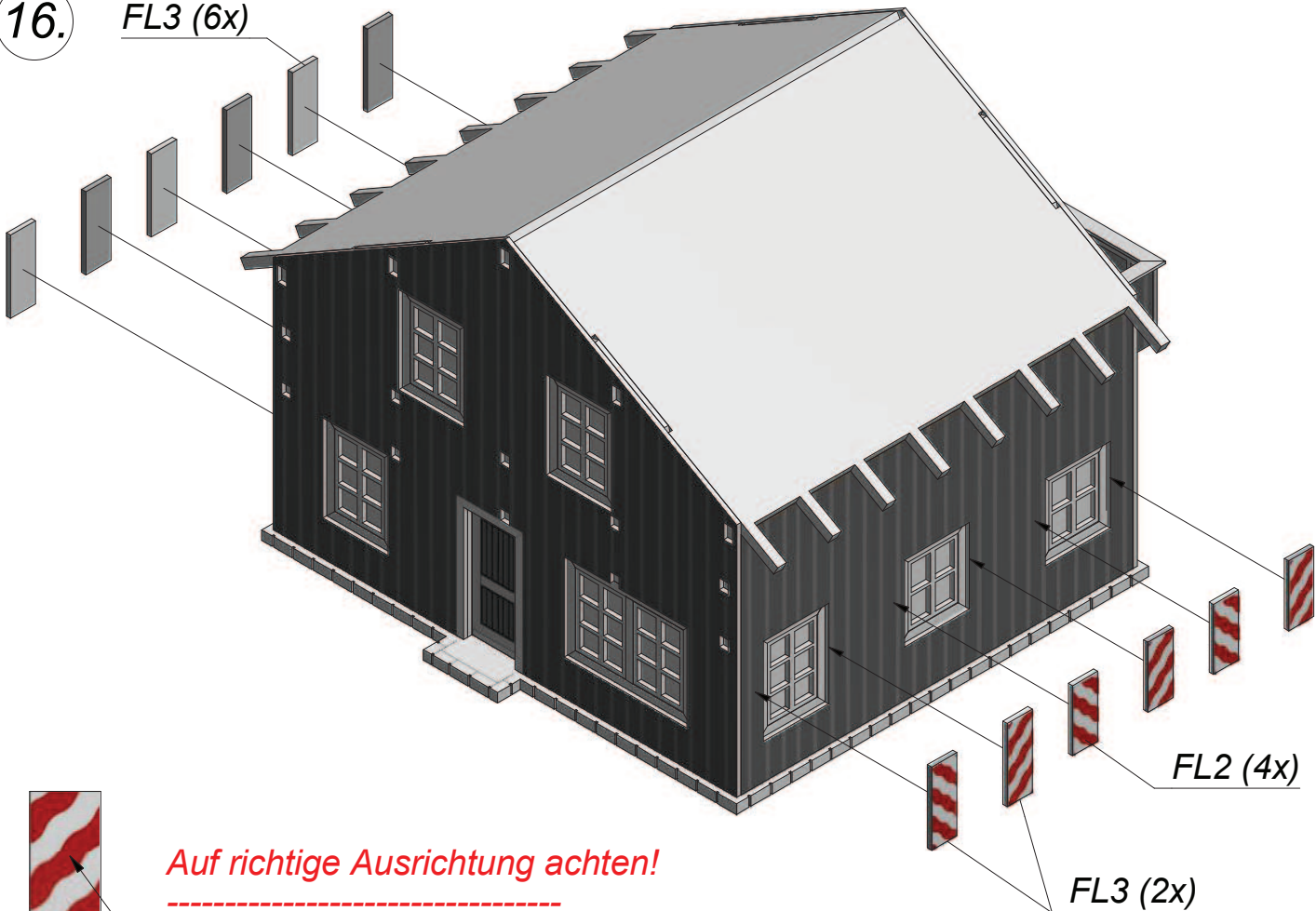

FL2 (4x)

FL3 (2x)



Auf richtige Ausrichtung achten!

Pay attention to correct position!

17.

Auf richtige Ausrichtung
achten!

Pay attention
to correct position!



oben / at the top



1 (5x)

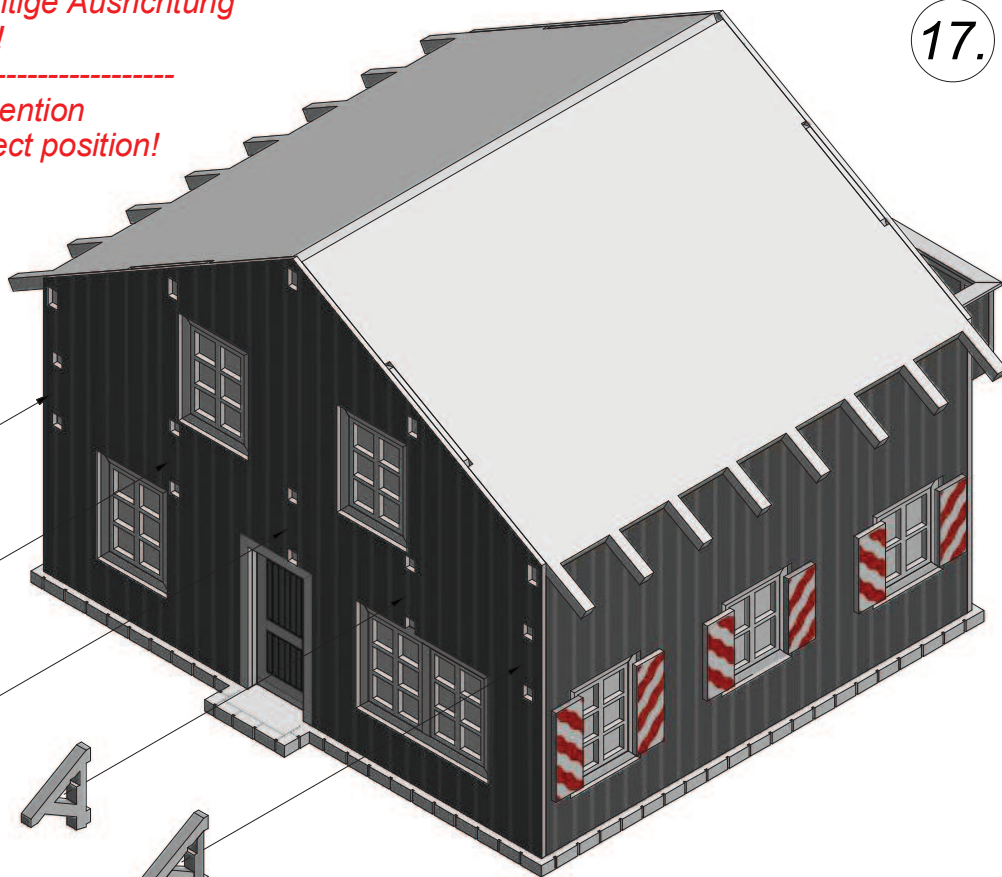

18.

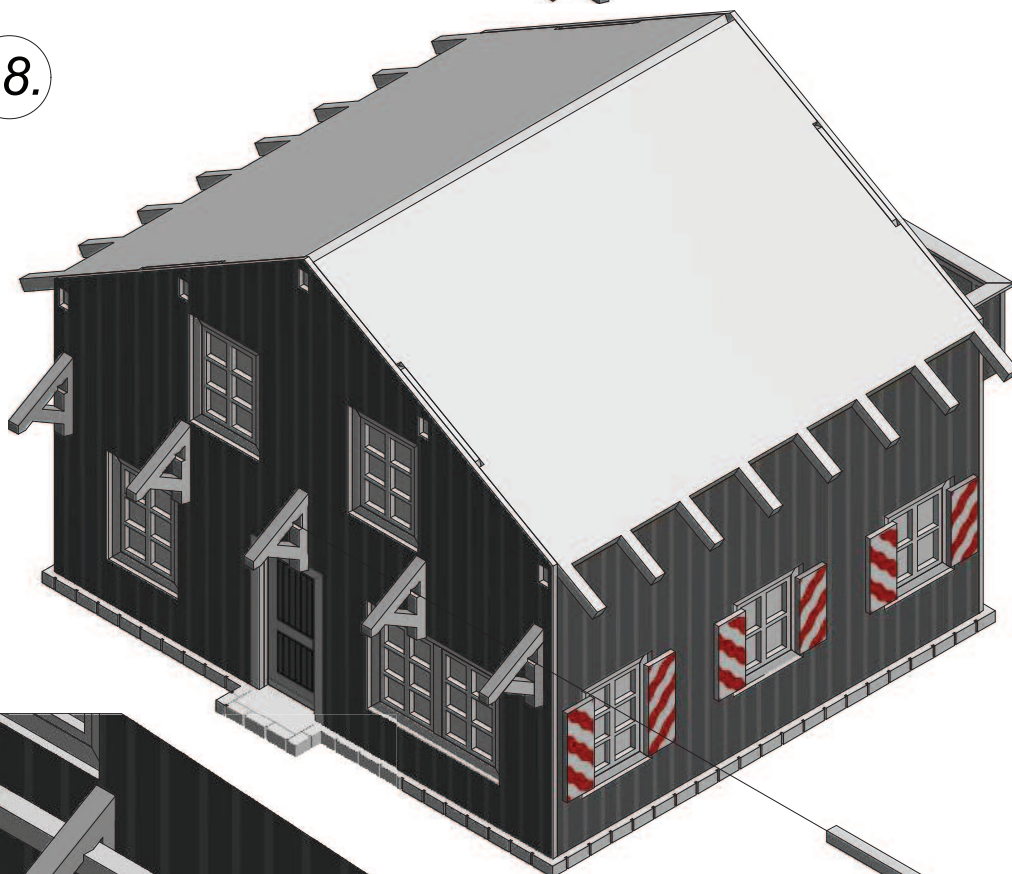

6

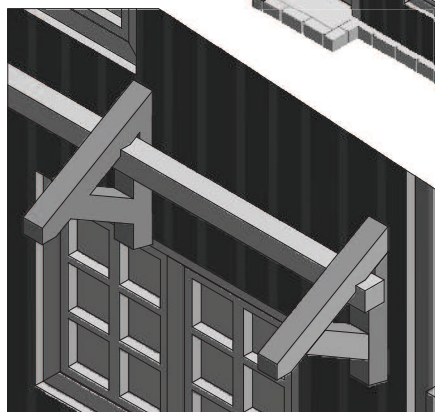

19.

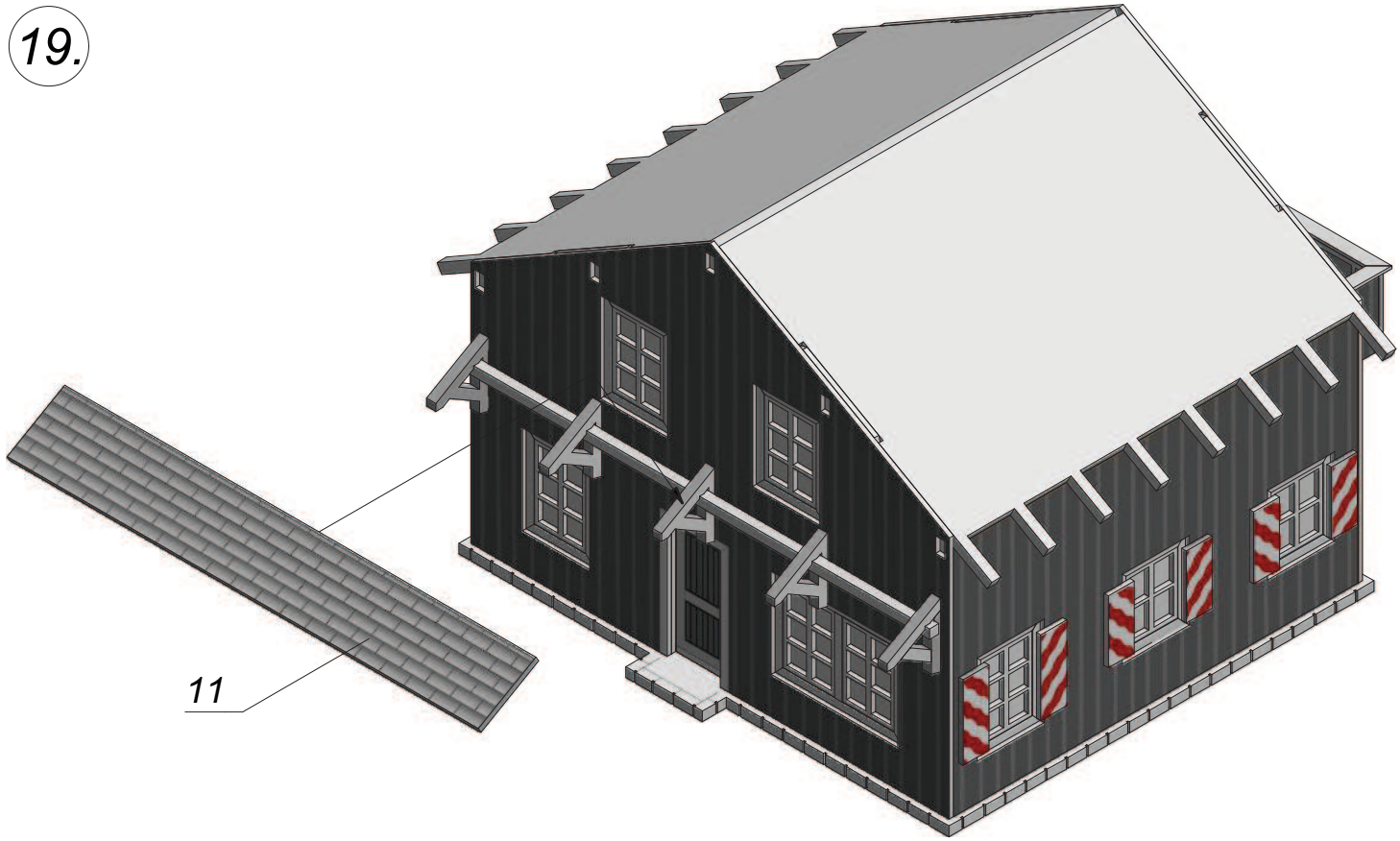

20.

- *Schneiden*

Cut
- *Knicken*

Fold
- *Kleben*

Glue

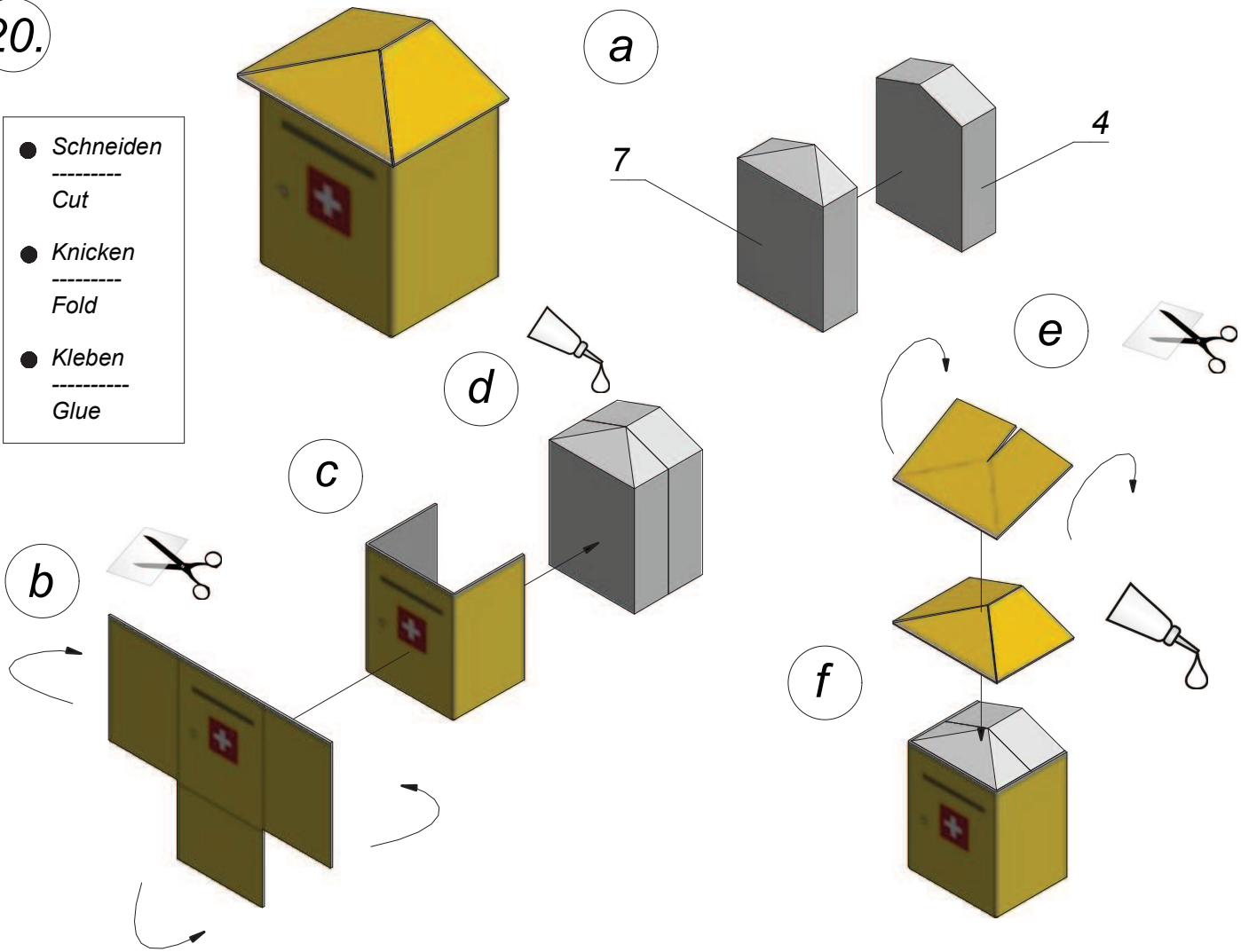

21.

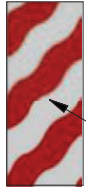

Auf richtige Ausrichtung achten!

Pay attention to correct position!

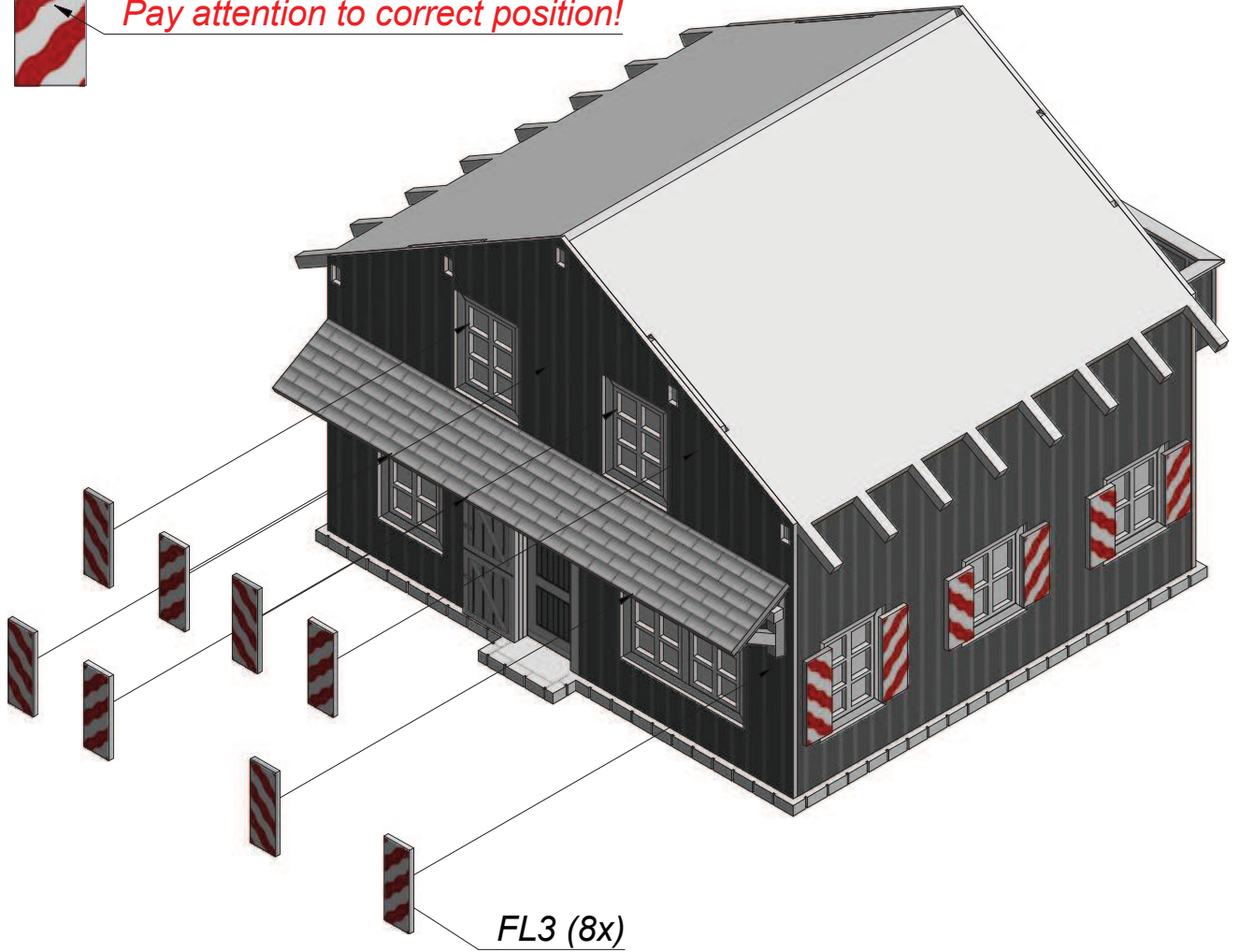

FL3 (8x)

22.

28

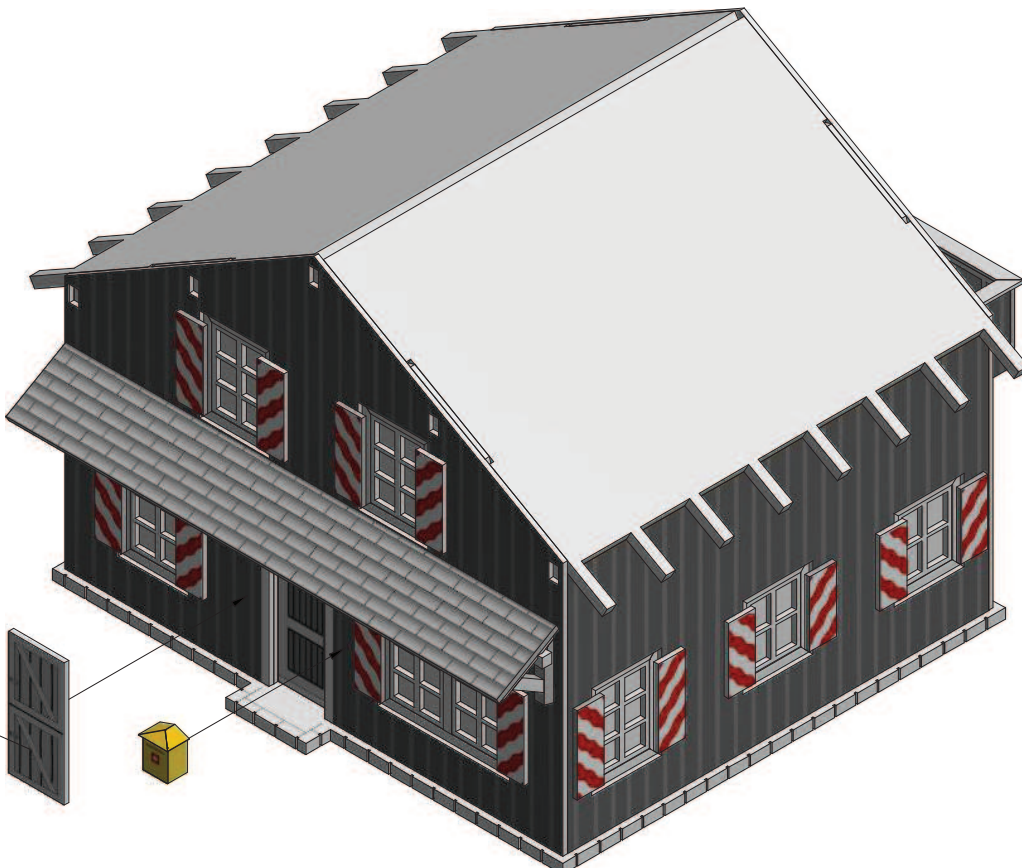

23.

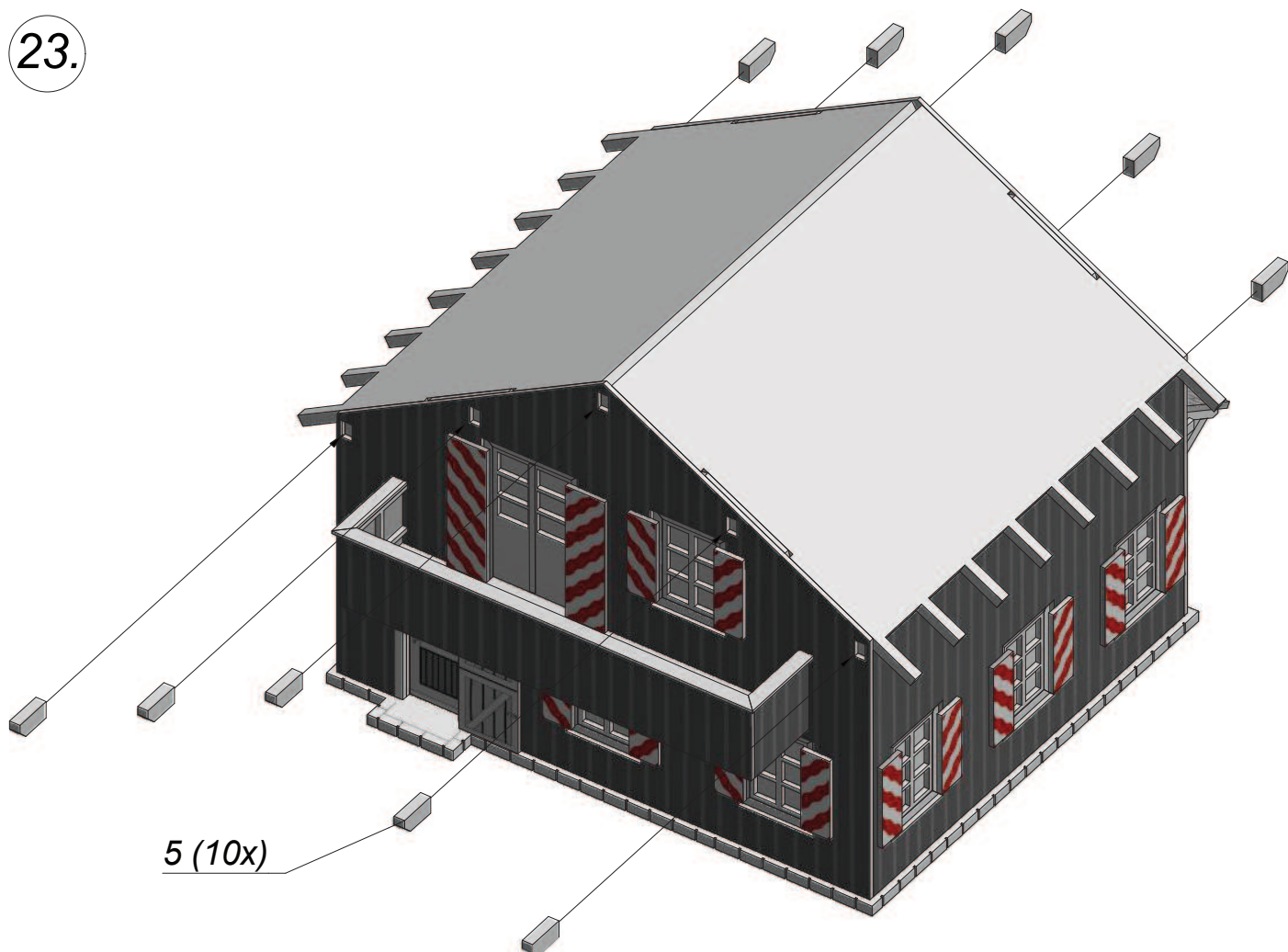

24.

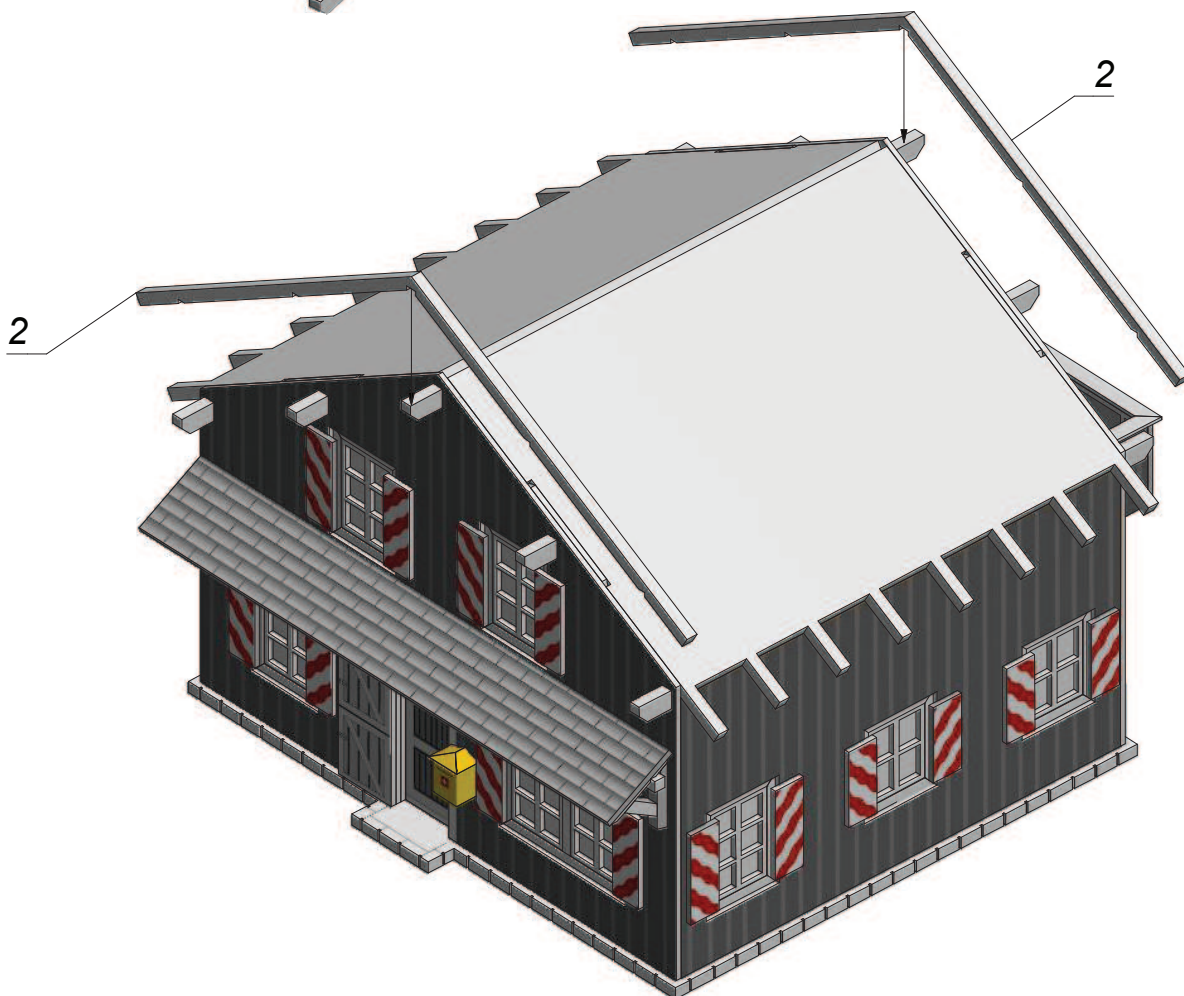

25.

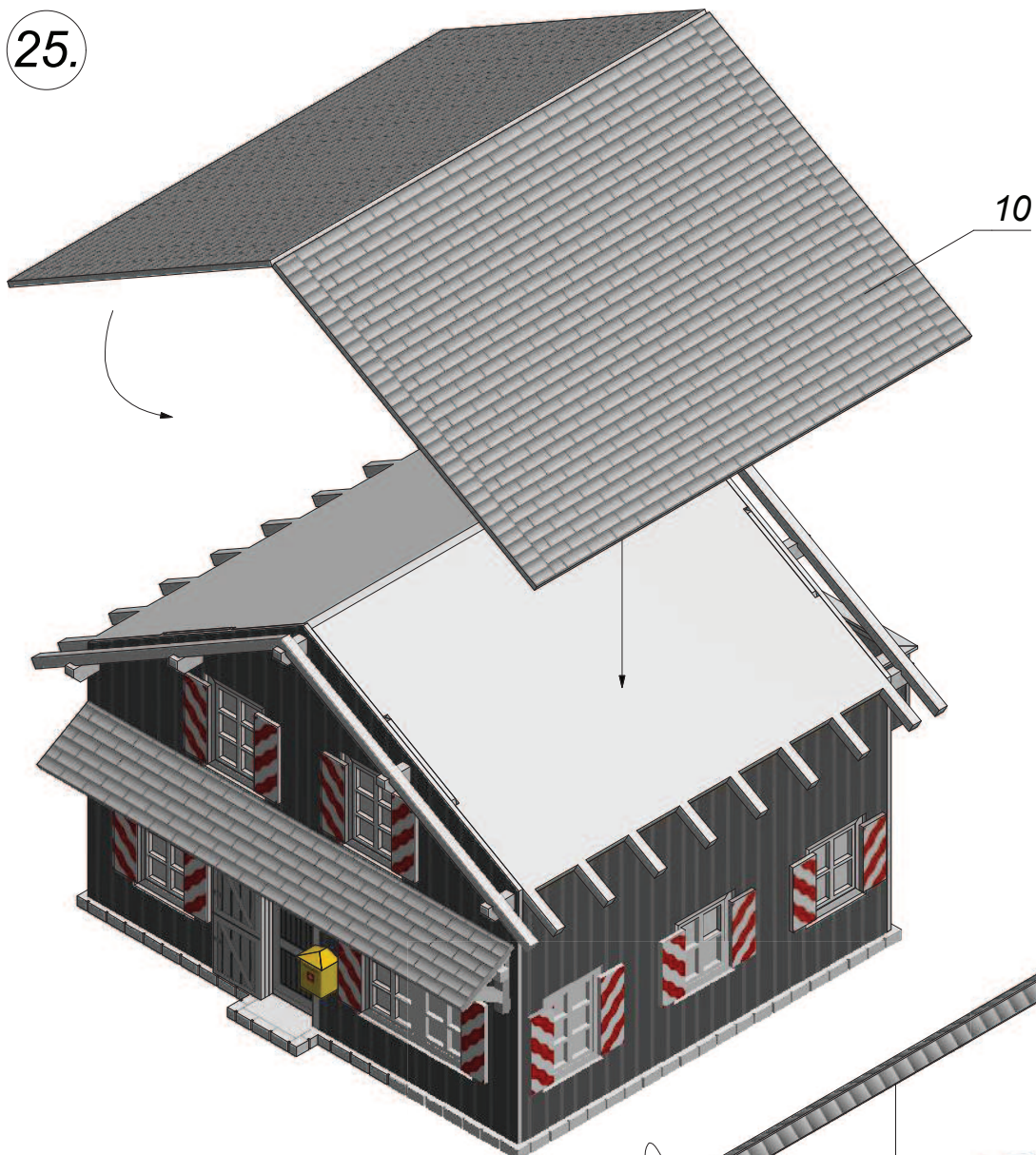

9

26.

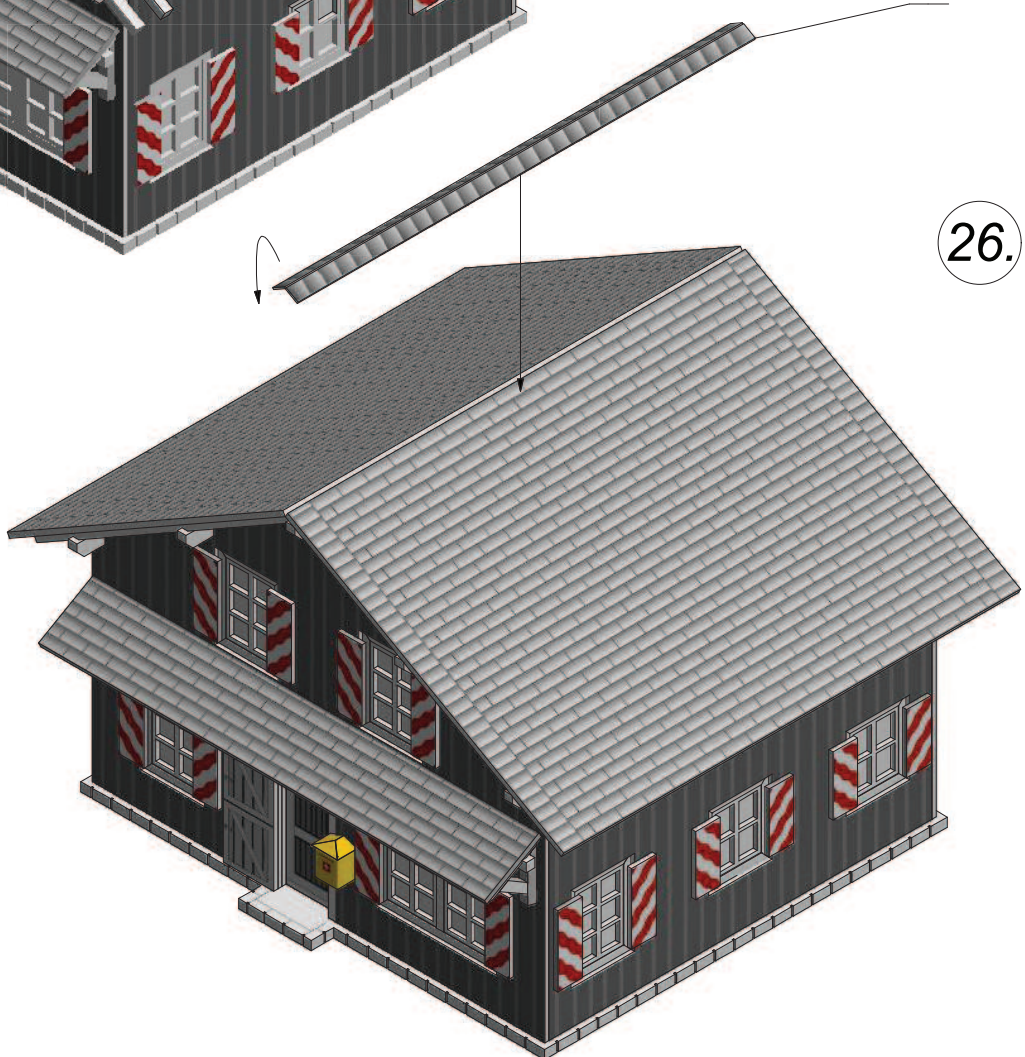

27.

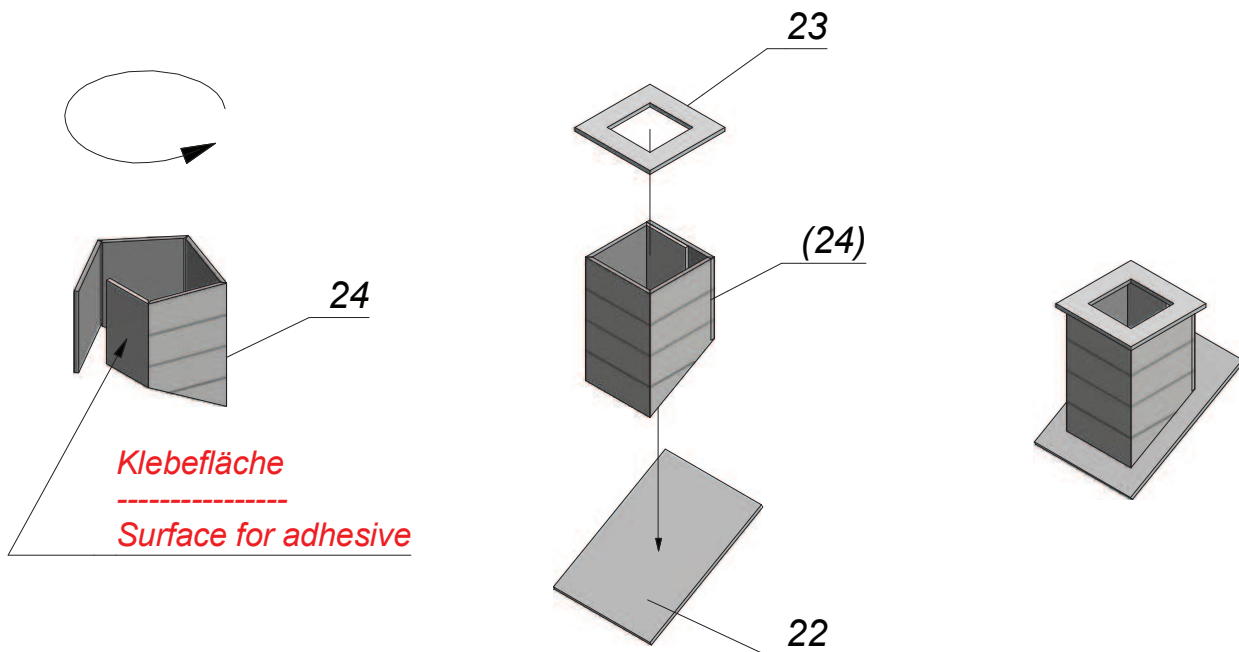

28.



29.

S = Schilder nach Wahl.

Add labels at your choice.

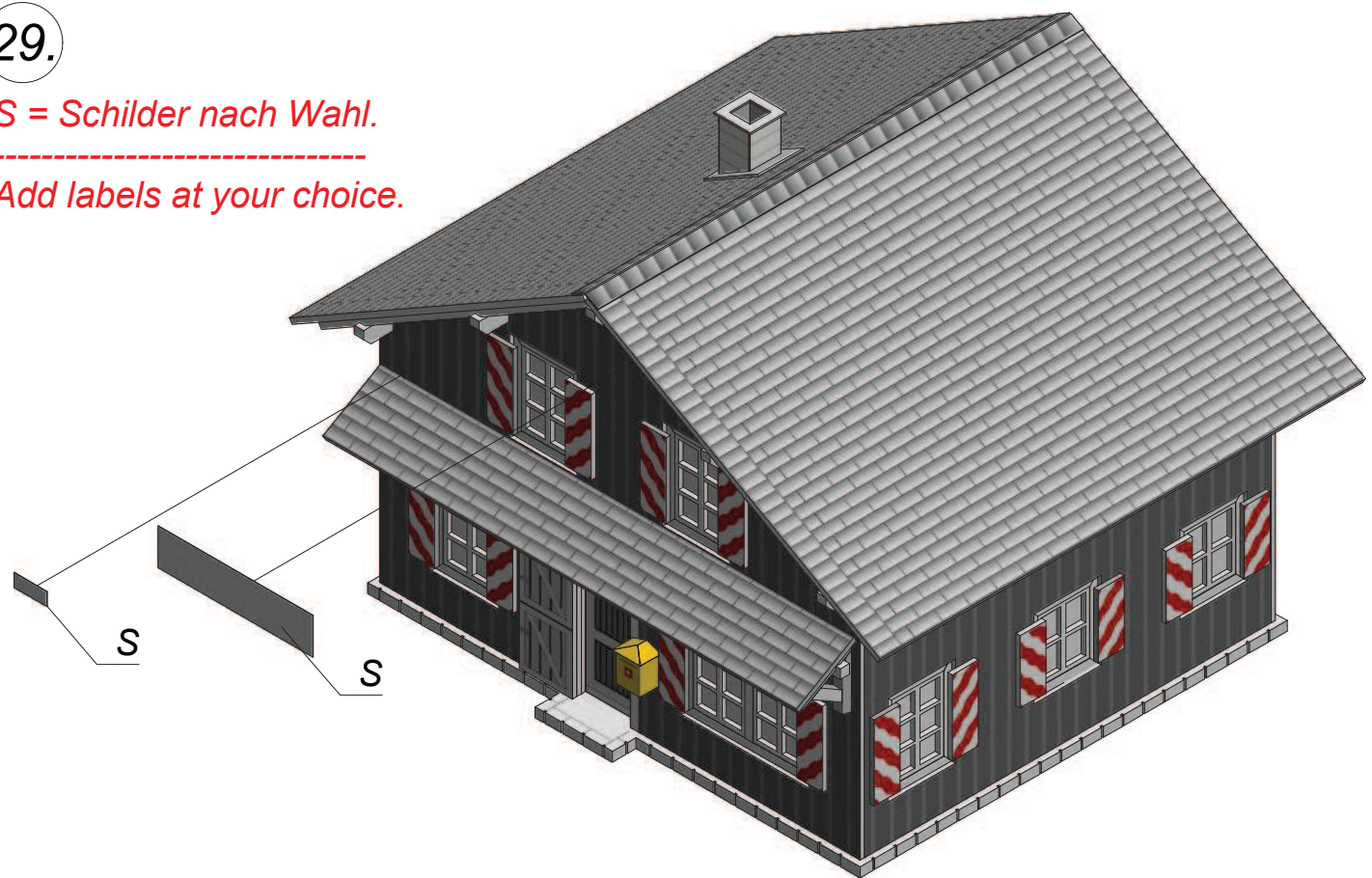

30.

Freie Gestaltungsmöglichkeit mit Deko-Bogen.

Arrange with the deco-sheet at your choice.

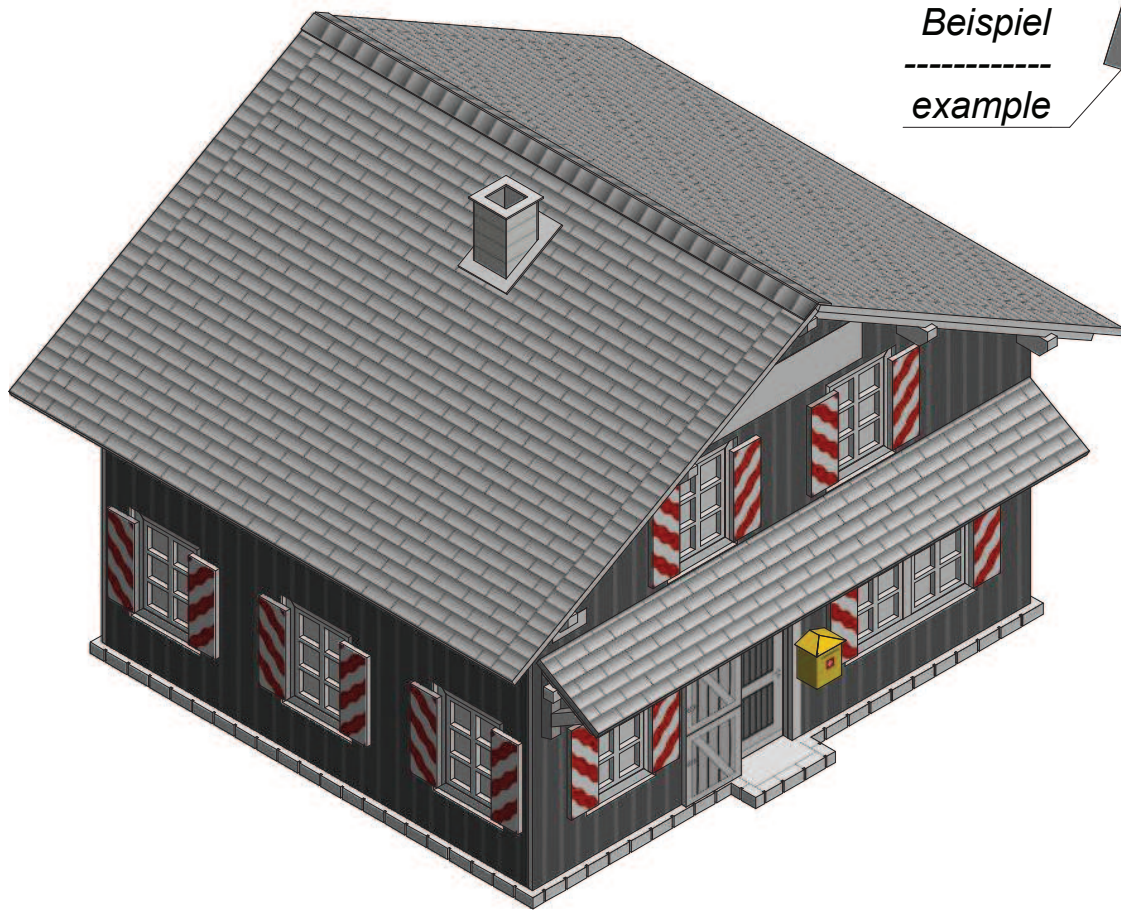

Beispiel

example

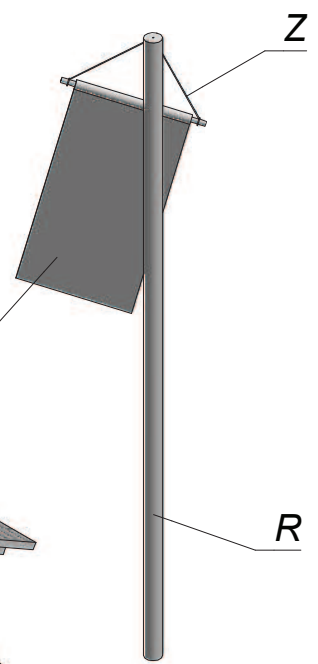

- Schneiden

Cut
- Knicken

Fold
- Kleben

Glue