

**TRIX**  
H0

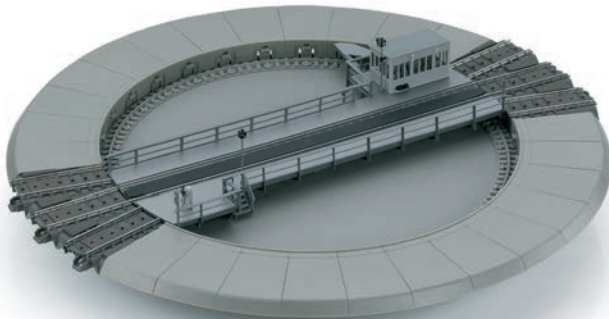

---

C-Gleis Drehscheibe  
**66861**

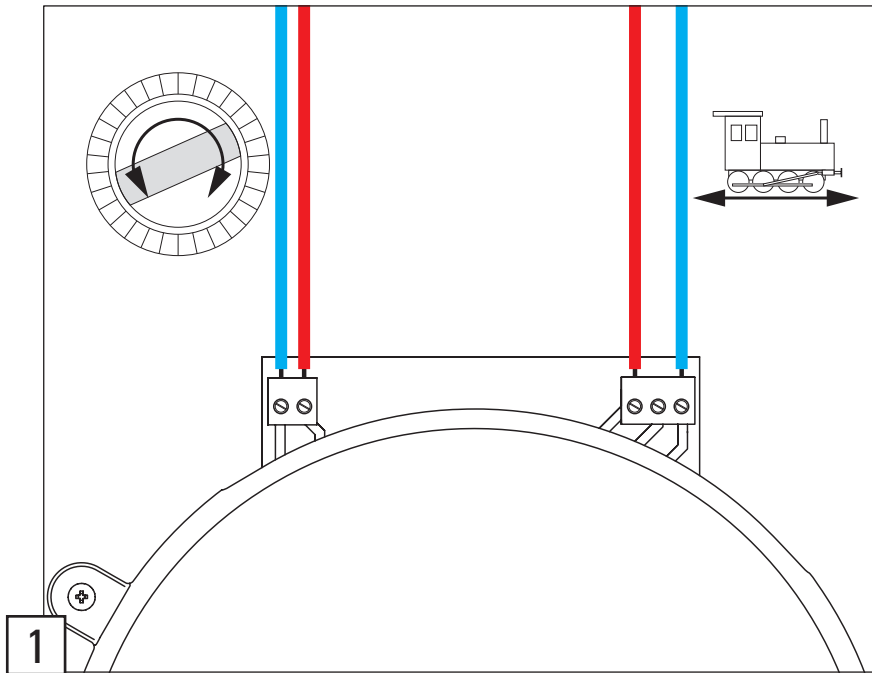

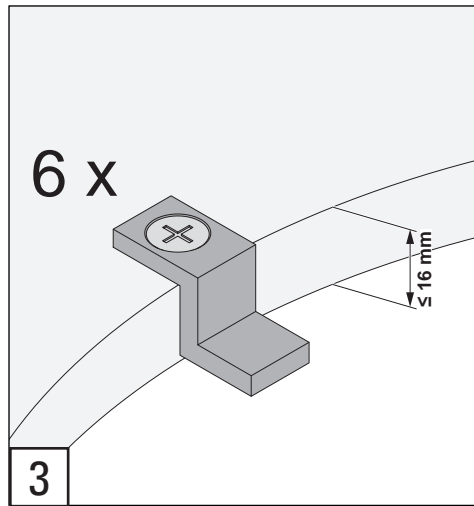
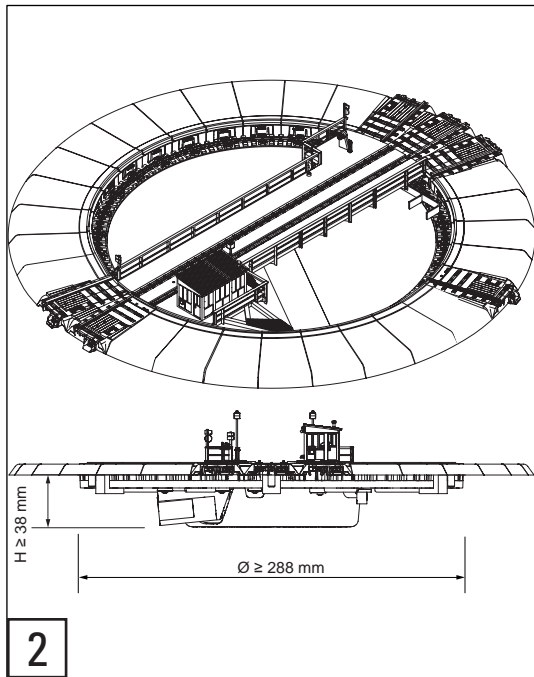

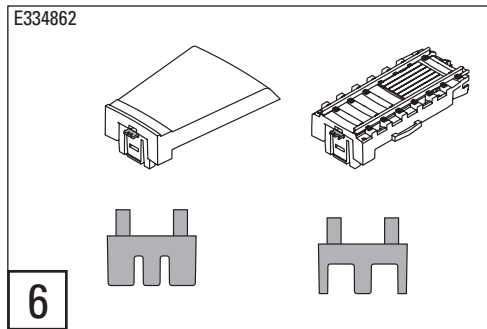
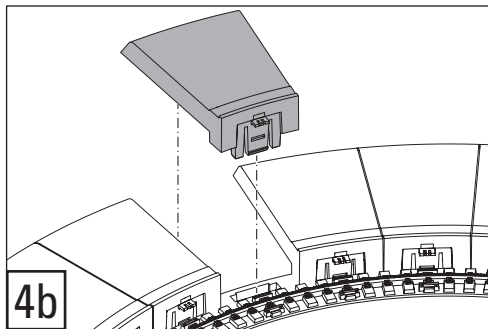
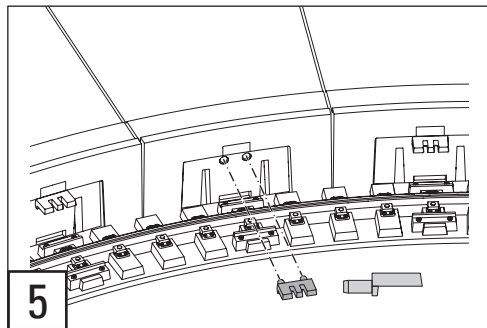
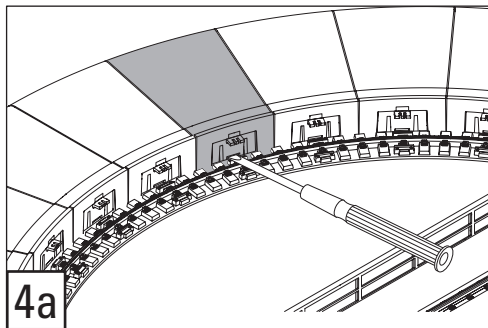

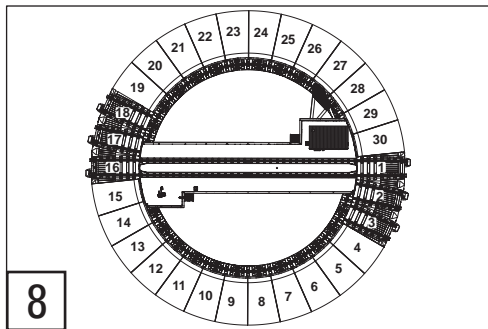
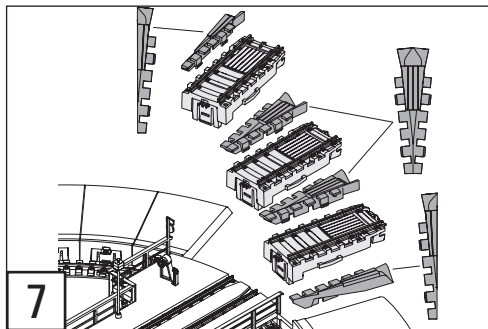

Bilder zum Aufbau und Anschluss	2
Sicherheitshinweise	8
Allgemeine Hinweise	8
Funktionen	8
Ergänzungen	8
Anschluss	8
Aufbau	8
Wartung	9
Betrieb	9
Gleispläne	42

Illustrations pour montage et raccordement	2
Consignes de sécurité	16
Indications générales	16
Fonctions	16
Compléments	16
Raccordement	16
Montage	16
Entretien	17
Exploitation	17
Tracés des voies	42

Images for Setup and Connections	2
Safety Notes	12
General Notes	12
Functions	12
Add-Ons	12
Connections	12
Setup	12
Maintenance	13
Operation	13
Track Plans	42

Afbeeldingen over opbouw en aansluiting	2
Veiligheidswenken	20
Algemene informatie	20
Functies	20
Uitbreidingen	20
Aansluiting	20
Opbouw	20
Onderhoud	21
Bedrijf	21
Sporschema's	42

Imágenes para el montaje y la conexión	2
Consejos de seguridad	24
Indicaciones generales	24
Funciones	24
Complementos	24
Conexión	24
Montaje	24
Mantenimiento	25
Empleo	25
Esquemas de vías	42

Bilder på montering och anslutning	2
Säkerhetsanvisningar	32
Allmänna anvisningar	32
Funktioner	32
Utbyggnad	32
Anslutning	32
Montering	33
Underhåll	33
Drift	33
Spårplaner	42

Figure per il montaggio e il collegamento	2
Avvertenze di sicurezza	28
Avvertenze generali	28
Funzioni	28
Ampliamenti	28
Collegamento	28
Montaggio	28
Manutenzione	29
Esercizio	29
Tracciati di binario	42

Illustrationer til montering og tilslutning	2
Sikkerhedsvejledning	36
Generel vejledning	36
Funktioner	36
Tilføjelser	36
Tilslutning	36
Montering	36
Vedligeholdelse	37
Drift	37
Spørplaner	42

## Sicherheitshinweise

- nur zur Verwendung in geschlossenen Räumen
- **ACHTUNG!** Funktionsbedingte scharfe Kanten und Spitzen.
- Verbaute LED's entsprechen der Laserklasse 1 nach Norm EN 60825-1.

## Allgemeine Hinweise

- Die Bedienungsanleitung ist Bestandteil des Produktes und muss deshalb aufbewahrt sowie bei Weitergabe des Produktes mitgegeben werden.
- Entsorgung: [www.maerklin.com/en/imprint.html](http://www.maerklin.com/en/imprint.html)

## Funktionen

Die Drehscheibe 66861 ist sowohl bei analogem als auch bei digitalem **Fahrbetrieb** einsetzbar. Für den digitalen Betrieb der Drehscheibe selbst ist ein zusätzliches digitales Steuergerät (mfx oder DCC) notwendig. Ein eigener Spannungsanschluss für die Drehscheibe wird nicht benötigt.

Im Auslieferungszustand sind 2 x 3 Anschlussgleise vorgesehen. Mit dem Erweiterungsset 66871 kann die Drehscheibe auf max. 30 Anschlussgleise (12°-Raster) ausgebaut werden.

## Ergänzungen

Die Rand-Segmente der Drehscheibe können beliebig ausgetauscht werden und lassen somit eine optimale Anpassung an die gewünschte Gleisanlage zu (Randsegment nach oben aus der Drehscheibe herausheben, Seite 4, Bilder 4). Mit der Erweiterung 66871 kann die Drehscheibe um weitere Anschlussgleise ergänzt werden. Diese Anschlussgleise können auch mit dem Endstück 62001 zu einem vorbildgerechten Blindgleis ausgebildet werden.

Der Ringlokschuppen (Märklin) 72886 kann passend neben der Drehscheibe aufgestellt werden.

## Anschluss

Die Drehscheibe hat einen Anschluss zur Steuerung der Drehscheibe mit einem digitalen Steuergerät (z.B. Central Station 2 / 3) sowie einen Gleisanschluss zur Versorgung des Gleises auf der Drehbühne (S. 2, Bild 1).

Die Anschlussgleise der Drehscheibe werden nur durch die Gleise auf der Anlage versorgt. Die Versorgung der Anschlussgleise über die Drehbühne ist nicht möglich.

## Aufbau

Die Drehscheibe ist zum versenkten Einbau in der Anlage vorgesehen. Dazu ist in der Grundplatte eine kreisförmige Aussparung mit einem **Durchmesser von mindestens 288 mm** und einer für den Betrieb notwendigen **Mindesthöhe von 38 mm** erforderlich (Seite 3, Bild 2). Es liegen 6 Kunststoffwinkel bei, die am Rand der Öffnung befestigt werden (Seite 3, Bild 3). Die Drehscheibe wird dann auf diesen Winkeln aufgelegt. Die Winkel müssen so platziert werden, dass sie jeweils **mittig** unter einem Blind- oder Auffahrtsgleise angeordnet sind.

Beachten Sie bitte, dass die eingebaute Drehscheibe von unten zugänglich sein sollte.



1. Geeignete Stelle für die Drehscheibe auf der Anlage auswählen (genug Platz auch nach unten; die Drehscheibe sollte von unten zugänglich sein).
2. Die Aussparung in der Anlagenplatte fräsen ( $\varnothing \geq 288$  mm). Die beiliegende Schablone kann bei der genauen Positionierung hilfreich sein.
3. Die benötigten Anschlussgleise an der Drehscheibe anbauen und die entsprechenden Abfragezapfen überprüfen (siehe auch Bilder 5 & 6).
4. Drehscheibe in die Aussparung legen. Jetzt können die geeigneten Stellen für die Befestigungswinkel auf der Platte markiert werden.
5. Drehscheibe wieder auf die Seite legen und die Befestigungswinkel am Rand der Aussparung anschrauben (Schrauben vorbohren).
6. Drehscheibe elektrisch anschließen.
7. Drehscheibe einbauen und mit den vorgesehenen Gleisen verbinden.

**Die Drehscheibe muss schwimmend, zwangsfrei und eben montiert sein!**

## Wartung



Die Drehscheibe 66861 ist wartungsfrei.

## Betrieb

Voreingestellt ist die Adresse 225 (DCC).

Die Drehscheibe kann mit maximal 2 x 15 Anschlussgleisen ausgestattet werden. Ausgehend vom Gleis 1 sind die möglichen Anschlussgleise im Uhrzeigersinn durchnummeriert (Seite 5, Bild 8). Nachdem zunächst die Drehrichtung vorgegeben wurde, können die einzelnen Gleise wahlweise direkt oder schrittweise angesprungen werden.

Die Umschaltung der Gleispolarität erfolgt beim Wechsel zwischen den Gleisen 8 und 9 bzw. zwischen 23 und 24. Eingaben werden von der Drehscheibe über unterschiedliche Beep-Töne quittiert.

normale Eingabe	Beep	
Programmierung erfolgreich	Beep Beep Beep	
Fehler	Beep Beep Beep	

### Betrieb mit der Central Station 3

Die Drehscheibe 66861 muss wie andere mfx-fähige Zubehörartikel über die Funktion „mfx-Artikel suchen“ angemeldet werden. Danach muss das Gleis 1 festgelegt und die Drehscheibe initialisiert werden.

### Betrieb mit der Central Station 2

Die Drehscheibe wird zunächst über die Funktion „mfx-Artikel suchen“ im keyboard angemeldet (keyboard, Konfiguration, Taste ). Danach kann sofort das Gleis 1 festgelegt und die Drehscheibe initialisiert werden.

### **Betrieb mit dem Signal-Schaltpult 72760 (Analogbetrieb)**

Der eingeschränkte Analogbetrieb mit dem Signal-Stellpult (Märklin) 72760 ist möglich. Dazu muss der Decoder mit einer CS2/CS3 auf den MM-Betrieb (Adresse 255) umgestellt werden. Die Festlegung von Gleis 1, die Initialisierung und das Anspringen von bestimmten Gleisen sind nicht möglich. Zum Anschluss der Drehscheibe an das Stellpult kann das Kabel E242325 verwendet werden. Es muss jedoch der kleinere Stecker (Signalseite!) dazu abgeschnitten werden. Für den Betrieb mit dem Stellpult 72760 muss die Drehscheibe auf die Adresse 1 programmiert werden.

### **Drehscheibe mit 72760 auf Adresse 1 programmieren**

Die hier beschriebene Programmierung funktioniert immer, egal welche Adresse zu Beginn eingestellt ist. Die Programmierung beginnt etwa eine Sekunde nach dem die Spannung eingeschaltet wird.

- Taste 1 einschalten → Taste 1 ausschalten →
- Taste 2 einschalten → Taste 2 ausschalten →
- Taste 3 einschalten → Taste 3 ausschalten →
- Taste 4 einschalten → Taste 4 ausschalten

Mit dem Umgekehrten Ablauf (Taste 4 an, Taste 4 aus, ...) kann die Drehscheibe wieder auf die Adresse 225 zurück gestellt werden.

### **Gleis 1 selbst festlegen**

1. gewünschtes Gleis 1 anfahren
2. Anlage ausschalten („STOP“ am Steuergerät)
3. Anlage wieder einschalten und innerhalb von 5 Sekunden die Tasten <clear><input><clear> drücken

Hinweis: Solange die Verriegelung der Bühne offen ist, nimmt die Drehscheibe keine Schaltbefehle entgegen.

### **Initialisierung**

































Bei der Initialisierung läuft die Drehscheibe ein Mal durch den ganzen Kreis und liest die Anschlussgleise aus. So bleibt die Drehscheibe im Betrieb nur noch an tatsächlichen Anschlussgleisen stehen.

Wenn die Anordnung der Anschluss- oder Blindgleise an der Drehscheibe geändert wurden, muss die Drehscheibe neu initialisiert werden.

Die Initialisierung kann innerhalb von 5 Sekunden nach dem Einschalten über die Tasten <end><input><end> gestartet werden.

### **Betrieb unter DCC**

Die Drehscheibe 66861 ist auf den Betrieb unter DCC / mfx voreingestellt. Sie kann auf MM umprogrammiert werden. Das ist aber nur mit der Central Station 2 / 3 unter mfx möglich. Sie kann auch nur so wieder zurück gestellt werden. Das Umprogrammieren für den Betrieb mit dem Schaltpult 72760 ist unter DCC **nicht** möglich.

CS2*/CS3	(CS2)*	72760	MS2 Adresse	Funktion
	end		225	Drehbewegung wird am nächsten Gleis beendet
	input	Taste 1	225	Ent- / Verriegeln der Bühne (ein = entriegeln)
	clear		226	Weiterfahren nach STOP
	turn	Taste 2	226	Drehung um 180°
	step 	Taste 4	227	Bühne dreht bis zum nächsten Gleis im Uhrzeigersinn
	step 	Taste 3	227	Bühne dreht bis zum nächsten Gleis gegen den Uhrzeigersinn
			228	Vorwahl der Drehrichtung im Uhrzeigersinn
			228	Vorwahl der Drehrichtung gegen den Uhrzeigersinn
**			229 – 236	Zielgleis das angefahren werden soll
			236	Geräusch: Ansage Drehscheibenwärter
	16 		237	Betriebsgeräusch aus
	17 		237	Betriebsgeräusch an
	18 		238	Soundsignal: „(Lok) rankommen“
	19 		238	Soundsignal: „(Bühne) wegfahren“
	20 		239	Licht aus (innen)
	21 		239	Licht an (innen)
	22 		240	Licht aus (außen)
	23 		240	Licht an (außen)
	24 		240	Licht an (außen)

\* die Darstellung auf der CS2 ist abhängig von der Software-Version der CS2

\*\* In der CS3 können die Gleise über die Berührung des gewünschten Gleises auf dem Display angefahren werden. Es sind keine besonderen Tasten vorgesehen.  
Hinweis: Solange die Verriegelung der Bühne offen ist, nimmt die Drehscheibe keine Schaltbefehle entgegen.

## Safety Notes

- Only for use in enclosed spaces
- **IMPORTANT!** Sharp edges and points due to the model's function.
- Built-in LEDs correspond to Laser Class 1 according to Norm EN 60825-1.

## General Notes

- The operating instructions are a standard part of the product must therefore be kept in a safe place when transferring the product to a third party.
- Disposal: [www.maerklin.com/en/imprint.html](http://www.maerklin.com/en/imprint.html)

## Functions

The 66861 turntable can be used with analog as well as with digital **running operation** of locomotives. An additional digital control device is necessary for operation of the turntable itself (mfX or DCC). The turntable does not require its own voltage connection.

As delivered, the turntable is provided with 2 x 3 spoke tracks. The turntable can be expanded to a maximum of 30 spoke tracks (12° spacing) with the 66871 extension set.

## Add-Ons

The edge segments for the turntable can be removed as desired and therefore allow optimal adaption to the desired track location (Lift the edge segments up and out of the turntable, page 4, figure 4).

The turntable can be expanded by several spoke tracks with the 66871 extension set. These spoke tracks can also be finished off with the 62001 end piece to make a prototypical

blind track.

The (Märklin) 72886 roundhouse locomotive shed can be set up appropriately next to the turntable.

## Connections

The turntable has a connection for control of the turntable with a digital controller (example: Central Station 2 / 3) as well as a track connection for supplying power to the track on the turntable deck (page 2, figure 1).

The spoke tracks for the turntable can only be supplied with power from the tracks on the layout. It is not possible to supply power from the turntable deck.

## Setup

The turntable is designed for sunken installation on the layout. To do this, a circular opening in the benchwork with a **diameter of at least 288 mm / 11-3/8"** and a **minimum depth of 38 mm / 1-1/2"** necessary for operation is required (page 3, figure 2). Six (6) plastic brackets are included with the turntable, and they are mounted on the edge of the opening (page 3, figure 3). The turntable is then installed on these brackets. The brackets must be placed so that they are **centrally** located under a blind or spoke track.

Please note that the installed turntable should be accessible from below.

1. Select a suitable location for the turntable on the layout (also enough space below; the turntable should be accessible from below).
2. Cut the opening in the layout's benchwork (dia.  $\geq 288$  mm / 11-3/8"). The pattern included with the turntable will help in positioning the turntable exactly.
3. Install the required spoke tracks on the turntable and check the appropriate detection pins (see also figures 5 & 6).
4. Lay the turntable in the opening. Now suitable locations for the mounting brackets can be marked on the benchwork.
5. Put the turntable aside and screw the mounting brackets on the edge of the opening (predrill screws).
6. Make the electrical connections for the turntable.
7. Install the turntable and connect it to the tracks provided for it.

**The turntable must be mounted floating, free of constraints and level!**

## Maintenance

The 66861 turntable requires no maintenance.



## Operation

The address is preset at 225 (DCC).

The turntable can be equipped with a maximum of 2 x 15 spoke tracks. Starting with Track 1, the possible spoke tracks are consecutively clockwise (page 5, figure 8). After first setting the direction of rotation, you can move the deck directly to the individual tracks or in steps.

The track polarity is changed by changing between Tracks 8 and 9 or between 23 and 24.

Entries are confirmed by the turntable using various beeping sounds.

Normal entry	Beep	
Programming successful	Beep Beep Beep	
Errors	Beep Beep Beep	

### Operation with the Central Station 3

The 66861 turntable must like other mfx-capable accessory items be registered using the function „Search mfx Items“. After that, Track 1 must be defined and the turntable must be initialized.

### Operation with the Central Station 2

The turntable is initially registered in the keyboard using the function „Search mfx Items“ (keyboard, Configuration, button ). After that, Track 1 can be defined immediately and the turntable can be initialized.

### Operation with the 72760 Signal Controller (Analog Operation)

Limited analog operation is possible with the 72760 (Märklin) signal controller. To do this, the decoder must be set using a CS2/CS3 to MM operation (Address 255). Defining Track 1, the initialization and jumping from particular tracks are not possible.

The E242325 cable can be used to connect the turntable to the controller. However, the smaller plug (signal side!) to it must be cut off. The turntable (ex. with a Central Station) must be programmed to Address 1 for operation with the 72760 controller (Reprogramming with the controller is not possible!).

### Programming the Turntable with the 72760 for Address 1

The programming described here always works regardless of which address is set at the beginning. The programming begins about one second after the voltage is turned on.

Turn Button 1 on → turn Button 1 off →

Turn Button 2 on → turn Button 2 off →

Turn Button 3 on → turn Button 3 off →

Turn Button 4 on → turn Button 4 off

With the opposite procedure (Button 4 on, Button 4 off, ...), the turntable can be set back to address 225.

### Define Track 1 itself

1. Run onto desired Track 1
2. Turn off layout („STOP“ on controller)
3. Turn layout back on and within 5 seconds press the buttons <clear><input><clear>

Note: The turntable accepts no switching commands as long as the locking feature for the deck is open.

### Initializing































When initializing, the turntable rotates a complete circle and evaluates the spoke tracks. The turntable thus remains only at actual spoke tracks.

If you change the order of the spoke or blind tracks on the turntable, the turntable must be initialized again.

The initialization can be started within 5 seconds using the buttons <end><input><end> after turning the layout on.

### Operation with DCC

The 66861 turntable is preset for operation using DCC / mfx. It can be reprogrammed to MM. This is only possible however with the Central Station 2 / 3 using mfx. It can also be reprogrammed back. Reprogramming for operation with the 72760 control box using DCC **is not** possible.

CS2*/CS3	(CS2)*	72760	MS2 address	Function
	end		225	Rotation is ended at the next track
	input	Button 1	225	Unlocking/Locking the turntable deck (on = unlock)
	clear		226	Continuing to run after STOP
	turn	Button 2	226	Rotating 180°
	step 	Button 4	227	Deck rotates clockwise to the next track
	step 	Button 3	227	Deck rotates counterclockwise to the next track
			228	Preselection of the rotation direction clockwise
			228	Preselection of the rotation direction counterclockwise
**			229 – 236	Destination track to be stopped at
			236	Sound: Announcement of the turntable operator
			237	Operating sounds off
			237	Operating sounds on
			238	Sound signal: „(Locomotive) approaching“
			238	Sound signal: „(Deck) turning away“
			239	Light off (inside)
			239	Light on (inside)
			240	Light off (outside)
			240	Light on (outside)

\* The display on the CS2 depends on the software version for the CS2.

\*\* In the CS 3, you can stop at the tracks by touching the desired track on the display. No special buttons are provided for this.

Note: The turntable accepts no switching commands as long as the locking feature for the deck is open.

## Consignes de sécurité

- Uniquement pour l'utilisation dans des pièces fermées
- **ATTENTION!** Arêtes coupantes.
- Les LED intégrées correspondent à la classe de laser 1 selon la norme EN 60825-1.

## Indications générales

- La notice d'utilisation fait partie intégrante du produit ; elle doit donc être conservée et, le cas échéant, transmise avec le produit.
- Élimination [www.maerklin.com/en/imprint.html](http://www.maerklin.com/en/imprint.html)

## Fonctions

La plaque tournante réf. 66861 peut être utilisée aussi bien en **mode d'exploitation** analogique qu'en mode d'exploitation numérique. L'exploitation de la plaque tournante elle-même nécessite un appareil de commande numérique (mfx ou DCC) supplémentaire. La plaque tournante n'a pas besoin d'avoir sa propre alimentation.

Le coffret comprend 2x3 voies de raccordement. Le coffret de complément réf. 66871 permet d'agrandir la plaque tournante pour max. 30 voies de raccordement (selon schéma de 12°).

## Compléments

Les segments de bordure de la plaque tournante peuvent être échangés à votre guise et permettent ainsi une adaptation optimale au schéma des voies souhaité (soulever le segment pour le sortir de la plaque tournante, page 4, images 4).

Grâce à l'extension réf. 66871, la plaque tournante peut être complétée par d'autres voies de raccordement. Avec l'élément terminal réf. 62001, ces voies de raccordement

peuvent également former une voie sans issue réaliste. La rotonde (Märklin) réf. 72886 peut tout à fait trouver sa place à côté de la plaque tournante.

## Raccordement

La plaque tournante présente une connexion pour un appareil de commande numérique (tel que Central Station 2 / 3) ainsi qu'une connexion pour l'alimentation de la voie sur le pont tournant (P. 2, image 1).

Les voies de raccordement de la plaque tournante sont alimentées uniquement par les voies du réseau. L'alimentation des voies de raccordement via le pont tournant n'est pas possible.

## Montage

La plaque tournante est prévue pour une installation dans le plateau du réseau. A cet effet, le plateau doit présenter une découpe **circulaire d'au moins 288 mm** de diamètre et d'une **hauteur minimale** (nécessaire pour l'exploitation) de **38 mm** (page 3, image 2). Sont fournies six équerres en plastique à fixer sur le bord de l'ouverture (page 3, image 3). La plaque tournante est alors posée sur ces équerres. Les équerres doivent être positionnées de sorte à être respectivement **centrées** sous une voie sans issue ou une voie d'accès. Veillez à ce que la plaque tournante montée soit accessible par en dessous.



1. Choisir le bon endroit pour l'implantation de la plaque tournante sur le réseau (veillez à avoir suffisamment de d'espace également vers le bas, la plaque tournante doit être accessible par en dessous).
2. Percer le trou dans le plateau du réseau ( $\varnothing \geq 288$  mm). Le gabarit fourni peut faciliter le bon positionnement de la plaque.
3. Brancher les voies de raccordement nécessaires à la plaque tournante et vérifier les plots de contrôle (voir également images 5 & 6).
4. Positionner la plaque tournante dans l'orifice. Le positionnement adéquat des équerres de fixation peut maintenant être marqué sur le plateau du réseau.
5. Retirer la plaque tournante et visser les équerres de fixation sur le bord de l'orifice (vis de pré-perçage).
6. Effectuer le raccordement électrique de la plaque.
7. Insérer la plaque tournante et la relier aux voies prévues.

**La platine doit être montée flottante, sans contraintes et de niveau !**

### Entretien



La plaque tournante réf. 66861 ne nécessite aucun entretien.

### Exploitation

L'adresse prédéfinie est l'adresse 225 (DCC).

La plaque tournante peut être équipée au maximum de 2 x 15 voies de raccordement. En partant de la voie 1, les voies de raccordement possibles sont numérotées dans le sens des aiguilles d'une montre (page 5, image 8). Une fois que le sens de rotation a été défini, les différentes voies peuvent être abordées au choix directement ou pas à pas. La commutation de la polarité de la voie se fait lors du passage entre les éléments de voie 8 et 9 respectivement 23 et 24.

Les entrées sont confirmées par la plaque tournantes via différents « bip sonores ».

Entrée normale	Beep	
Programmation réussie	Beep Beep Beep	
Erreur	Beep Beep Beep	

### Exploitation avec la Central Station 3

Tout comme d'autres accessoires compatibles mfx, la plaque tournante réf. 66861 doit être enregistrée via la fonction « Rechercher articles mfx ». La voie 1 doit ensuite être déterminée et la plaque tournante initialisée.

### Exploitation avec la Central Station 2

La plaque tournante est d'abord enregistrée dans le keyboard via la fonction « Rechercher articles mfx » (keyboard, configuration, touche ). La voie 1 peut ensuite immédiatement être déterminée et la plaque tournante initialisée.

## Exploitation avec le pupitre de commande pour signaux 72760 (exploitation analogique)

Une exploitation limitée en mode analogique avec le pupitre de commande pour signaux (Märklin) réf. 72760 est possible. A cet effet, le décodeur doit être commuté en exploitation MM (adresse 225) avec une CS2/CS3. La détermination de la voie 1, l'initialisation et l'accès à certaines voies ne sont pas possibles.

Le raccordement de la plaque tournante au pupitre de commande peut se faire via le câble E242325. A cet effet, le connecteur le plus petit (côté signal!), doit toutefois être supprimé. Pour l'exploitation avec le pupitre de commande réf. 72760, la plaque tournante doit être programmée (par ex. avec une Central Station) sur l'adresse 1 (le changement de programmation n'est pas possible avec le pupitre de commande!).

### Programmer la plaque tournante avec 72760 sur l'adresse 1

La programmation décrite ici fonctionne toujours, quelle que soit l'adresse définie au départ. La programmation débute environ une seconde après la mise sous tension.

Enclencher touche 1 → Désenclencher touche 1 →

Enclencher touche 2 → Désenclencher touche 2 →

Enclencher touche 3 → Désenclencher touche 3 →

Enclencher touche 4 → Désenclencher touche 4

Avec le déroulement inverse (enclencher touche 4, désenclencher touche 4, la plaque tournante peut être réinitialisée à l'adresse 225.

## Déterminez vous-même la voie 1

1. Entrer sur la voie 1 choisie
2. Mettre le réseau hors tension (« STOP » sur l'appareil de commande)
3. Remettre le réseau sous tension et en l'espace de 5 secondes, appuyer sur les touches <clear><input><clear>

Remarque : Tant que le verrouillage du pont est ouvert, la plaque tournante n'exécute aucun ordre de commande.

### Initialisation

Lors de l'initialisation, la plaque tournante fait une fois le tour complet et sélectionne les voies de raccordement. Ainsi, la plaque tournante ne s'arrête ensuite plus que devant les voies de raccordement effectives.

La modification de l'ordre des voies de raccordement ou voies sans issue sur la plaque tournante nécessite sa réinitialisation.

L'initialisation peut être lancée dans les 5 secondes suivant la mise sous tension via les touches <end><input><end>.

### Exploitation sous DCC

La plaque tournante réf. 66861 est préprogrammée pour l'exploitation sous DCC / mfx. Elle peut être reprogrammée pour l'exploitation sous MM. Toutefois, cela est possible uniquement avec la Central Station 2/3 sous mfx. Ce n'est qu'à cette condition également qu'elle pourra être réinitialisée. La reprogrammation pour l'exploitation avec le pupitre de commande réf. 72760 n'est **pas** possible sous DCC.

CS2*/CS3	(CS2)*	72760	MS2 adresse	Fonction
	end		225	La rotation s'arrête à la prochaine voie
	input	Touche 1	225	Déverrouillage/Verrouillage de la plate-forme (marche = ouvrir)
	clear		226	Reprise après STOP
	turn	Touche 2	226	Rotation de 180°
	step 	Touche 4	227	La plate-forme tourne dans le sens des aiguilles d'une montre jusqu'à la prochaine voie.
	step 	Touche 3	227	La plate-forme tourne dans le sens inverse des aiguilles d'une montre jusqu'à la prochaine voie.
			228	Présélection du sens de rotation dans le sens des aiguilles d'une montre
			228	Présélection du sens de rotation dans le sens inverse des aiguilles d'une montre
*			229 – 236	Voie cible devant être empruntée
			236	Bruitage Annonce Agent plaque tournante
			237	Bruitage d'exploitation désactivé
			237	Bruitage d'exploitation activé
			238	Signal sonore : « approcher (la locomotive) »
			238	Signal sonore : « Éloigner (le pont) »
			239	Éclairage désactivé (intérieur)
			239	Éclairage activé (intérieur)
			240	Éclairage désactivé (extérieur)
			240	Éclairage activé (extérieur)

\* Le représentation sur la CS2 dépend de la version logicielle de la CS2.

\*\* Avec la CS3, les voies peuvent être sélectionnées par simple effleurement de l'écran. Il n'y pas de touches particulières prévues à cet effet.

Remarque : Tant que le verrouillage du pont est ouvert, la plaque tournante n'exécute aucun ordre de commande.

## Veiligheidswenken

- alleen voor gebruik in gesloten ruimtes
- **LET OP!** Deze component heeft scherpe randen en punten.
- Ingebouwde leds zijn laserklasse 1 volgens de norm EN 60825-1.

## Algemene informatie

- De handleiding maakt deel uit van het product en moet daarom worden bewaard en meegegeven als het product aan een ander persoon wordt doorgegeven.
- Afvalverwijdering: [www.maerklin.com/en/imprint.html](http://www.maerklin.com/en/imprint.html)

## Funcities

De draaischijf 66861 kan worden ingezet bij analoog en digitaal **rijbedrijf**. Voor de draaischijf zelf is een digitale regelaar (mfx of DCC) nodig. De draaischijf heeft geen eigen spanningaansluiting nodig.

Bij levering zijn 2 x 3 aansluitsporen voorzien. Met uitbreidingsset 66871 kan de draaischijf worden uitgebreid tot max. 30 aansluitsporen (12°-raster).

## Uitbreidingen

De randsegmenten van de draaischijf kunnen worden vervangen en zo optimaal worden aangepast aan de modelbaan (randsegment naar boven uit de draaischijf halen, pag. 4, afb. 4a en 4b).

Met uitbreidingsset 66871 kan de draaischijf worden aangevuld met verdere aansluitsporen. Deze aansluitsporen kunnen met sluitstuk 62001 ook een getrouw kopspoor vormen. Ringlocomotiefloods (Märklin) 72886 past naast de draaischijf.

## Aansluiting

De draaischijf heeft een aansluiting voor een digitale regelaar van de draaischijf (bv. Central Station 2/3 en een spoor aansluiting voor voeding van het spoor op de draaibrug (pag. 2 afb. 1).

De aansluitsporen van de draaischijf worden alleen gevoed via de sporen op de spoorlijn. Voeding van de aansluitsporen via de draaibrug is niet mogelijk.

## Opbouw

De draaischijf wordt verlaagd in de modelbaan ingebouwd. Hiervoor is in de grondplaat een cirkelvormige uitsparing nodig met een **diameter van minstens 288 mm** en een **minimumhoogte van 38 mm** (pag. 3, afb. 2). Bij levering inbegrepen zijn 6 kunststof hoekprofielen die aan de rand van de uitsparing worden bevestigd (pag. 3, afb. 3). De draaischijf wordt dan op deze hoekprofielen gelegd. De hoekprofielen moet zo worden geplaatst dat ze altijd **in het midden** onder een kop- of aankomstspoor liggen.

Let op: de draaischijf moet van onderen toegankelijk zijn.

1. Kies op de modelbaan een geschikte plek voor de draaischijf. Let op dat er genoeg ruimte onder zit. De draaischijf moet van onderen toegankelijk zijn.
2. Zaag de uitsparing ( $\varnothing \geq 288$  mm).in de modelbaan-plaat. De bijgevoegde sjabloon is handig om precies te kunnen werken.
3. Breng de aansluitsporen aan op de draaischijf en controleer de uitleesprofielen (zie ook afb. 5 & 6).
4. Plaats de draaischijf in de uitsparing. Nu kunnen de posities voor de bevestigingsprofielen op de plaat gemarkeerd worden.
5. Leg de draaischijf weer weg en schroef de bevestigingsprofielen aan de rand van de uitsparing (schroeven voorboren).
6. Sluit de draaischijf elektrisch aan.
7. Monteer de draaischijf en sluit de sporen aan.

**De draaitafel moet zwevend, vrij van beperkingen en waterpas worden gemonteerd!**

## Onderhoud

De draaischijf 66861 is onderhoudsvrij.



## Bedrijf

Het adres 255 (DCC) is vooraf ingesteld.

De draaischijf kan maximaal 2 x 15 aansluitsporen hebben. Beginnend met spoor 1 zijn de aansluitsporen met de klok mee genummerd (pag. 5, afb. 8). Nadat de draairichting is aangegeven, kunnen de sporen naar keuze direct of stapsgewijs worden aangesprongen.

De spoorpolariteit wordt omgeschakeld bij het wisselen tussen spoor 8 en 9 of tussen 23 en 24.

Invoeren van instellingen wordt door de draaischijf bevestigd met verschillende pieptonen.

normale invoer	Beep	
Programmering succesvol	Beep Beep Beep	
Fout	Beep Beep Beep	

## Bedrijf met Central Station 3

Draaischijf 66861 moet net als andere accessoires die met mfx werken via de functie "mfx-Artikel suchen" worden aangemeld. Daarna moet spoor 1 worden vastgelegd en de draaischijf worden geïnitieerd.

## Bedrijf met Central Station 2

De draaischijf wordt eerst aangemeld via de de functie "mfx-Artikel suchen" in het keyboard (keyboard, configuratie, toets ). Daarna kan spoor 1 meteen worden vastgelegd en de draaischijf worden geïnitieerd.

### **Bedrijf met signaal-schakelbord 72760 (analoog bedrijf)**

Beperkt analoog bedrijf met de sein track lay-out 72760 (Märklin) is mogelijk. Hiervoor moet de decoder met een CS2/CS3 op MM-bedrijf (adres 255) worden omgeschakeld. Zelf vastleggen van spoor 1, initialiseren en aansprongen van bepaalde sporen zijn dan niet mogelijk.

Voor aansluiting van de draaischijf op het schakelbord kan kabel E242325 worden gebruikt. De kleinere stekker (seinkant!) moet dan wel worden afgesneden. Voor bedrijf met schakelbord 72760 moet de draaischijf (bv. met een Central Station) op adres 1 worden geprogrammeerd. Omprogrammeren is met het schakelbord niet mogelijk.

### **Draaischijf met 72760 op adres 1 programmeren**

De hier beschreven programmering werkt altijd, ongeacht welk adres in het begin is ingesteld. De programmering begint ongeveer een seconde na het inschakelen van de spanning

Toets 1 inschakelen → toets 1 uitschakelen →  
Toets 2 inschakelen → toets 2 uitschakelen →  
Toets 3 inschakelen → toets 3 uitschakelen →  
Toets 4 inschakelen → toets 4 uitschakelen

Met het omgekeerde proces (toets 4 aan, toets 4 uit, ...) kan de draaischijf weer worden gereset op adres 225.

### **Spoor 1 zelf vastleggen**

1. naar spoor 1 rijden
2. draaischijf uitschakelen (STOP op regelaar)
3. draaischijf weer inschakelen en binnen 5 seconden de toetsen `<clear><input><clear>` indrukken

Let op: zolang de vergrendeling van de brug open is, neemt de draaischijf geen schakelcommando's aan.

### **Initialiseren**

Bij het initialiseren loopt de draaischijf een keer door de hele cirkel en leest de aansluitsporen uit. Op de manier blijft de draaischijf in bedrijf alleen nog bij de aansluitsporen staan. Als u de rangschikking van aansluit- of kopsoren op de draaischijf verandert, moet de draaischijf opnieuw geïnitieerd worden.

Het initialiseren kan binnen 5 seconden na het inschakelen met de toetsen `<end><input><end>` worden gestart.

### **Bedrijf met DCC**

Draaischijf 66861 is ingesteld op bedrijf met DCC/mfx. Hij kan worden omgeprogrammeerd op MM. Dat is echter alleen mogelijk met Central Station 2/3 met mfx. Ook een reset is alleen zo mogelijk. Omprogrammeren voor bedrijf met schakelbord 72760 is met DCC **niet** mogelijk.

CS2*/CS3	(CS2)*	72760	MS2 adres	Functie
	end		225	Draaibeweging stopt bij het volgende spoor.
	input	Toets 1	225	Ont-/vergrendelen van de brug (aan = ontgrendelen)
	clear		226	Doorrijden naar STOP
	turn	Toets 2	226	180° draaien
	step 	Toets 4	227	Brug draait met de klok mee naar het volgende spoor.
	step 	Toets 3	227	Brug draait tegen de klok in naar het volgende spoor.
			228	Keuze van de draairichting met de klok mee
			228	Keuze van de draairichting tegen de klok in
**			229 – 236	Doelspoor waar de loc naar toe moet rijden
			236	Geluid: aankondiging draaischijfbewaker
			237	Bedrijfsgeluid uit
			237	Bedrijfsgeluid aan
			238	Soundsignaal loc naderen
			238	Soundsignaal (brug) wegrijden
			239	Licht uit (binnen)
			239	Licht aan (binnen)
			240	Licht uit (buiten)
			240	Licht aan (buiten)

\* De weergave op de CS2 is afhankelijk van de softwareversie van de CS2.

\*\* In CS3 kan er via aanraken van het gewenste spoor op het display naar de sporen worden gereden. Er zijn geen speciale toetsen voorzien.

Let op: zolang de vergrendeling van de brug open is, neemt de draaischijf geen schakelcommando's aan.

## Consejos de seguridad

- Está previsto para su uso únicamente en recintos cerrados
- **¡ATENCIÓN!** El equipo, debido a sus características funcionales, presenta cantos y puntas cortantes.
- Los LEDs integrados corresponden a la clase láser 1 según la norma EN 60825-1.

## Indicaciones generales

- Las instrucciones de empleo forman parte integrante del producto y, por este motivo, deben conservarse y entregarse al nuevo comprador en el caso de venta del producto.
- Para su eliminación: [www.maerklin.com/en/imprint.html](http://www.maerklin.com/en/imprint.html)

## Funciones

El puente giratorio 66861 se puede utilizar en **circulación** tanto en modo analógico como en digital. Para el empleo del propio puente giratorio se requiere una unidad de control digital adicional (mfx o DCC). No se requiere una conexión de tensión propia para el puente giratorio. En el estado en que se entrega se han previsto 2 grupos de 3 vías de enlace. El puente giratorio se puede ampliar a un máximo de 30 vías de enlace (paso entre vías de 12°) con el set de ampliación 66871.

## Complementos

Los segmentos periféricos del puente giratorio se pueden sustituir libremente y, por tanto, permiten una adaptación óptima a la instalación de vías deseada (simplemente extraer el segmento periférico hacia arriba apartándolo del puente giratorio, página 4, imágenes 4).

Con el set de ampliación 66871 es posible incorporar vías de enlace adicionales al puente giratorio. Estas vías de enlace

se pueden convertir en una vía ciega, como en el modelo real, también con la pieza terminal 62001.

El depósito circular de locomotoras (cocherón) 72886 (Märklin) se puede montar a juego con el puente giratorio, junto a éste.

## Conexión

El puente giratorio posee una conexión para control del puente giratorio a una unidad de control digital (p. ej., Central Station 2/3) así como una conexión de vía para la alimentación de la vía en el puente giratorio (pág. 2, imagen 1).

Las vías de enlace del puente giratorio se alimentan únicamente desde las vías de la maqueta de trenes. No es posible la alimentación de las vías de enlace a través de la plataforma giratoria.

## Montaje

El puente giratorio se ha previsto para su montaje escamoteado en la maqueta de trenes. Para tal fin, se requiere en la placa base una abertura circular con un **diámetro de como mínimo 288 mm** y una **altura mínima de 38 mm** para su funcionamiento (página 3, imagen 2). Se adjuntan 6 ángulos de plástico que se sujetan en el borde de la abertura (página 3, imagen 3). En tal caso, el puente giratorio se monta en estos ángulos. Los ángulos se deben colocar de tal modo que estén situados cada uno **centrado** debajo de una vía ciega o una vía de acceso.

Tenga presente que el puente giratorio incorporado debe estar accesible desde abajo.



1. Elegir un punto adecuado para la plataforma giratoria en la maqueta de trenes (suficiente espacio también hacia abajo, el puente giratorio debe estar accesible desde abajo).
2. Fresar la abertura en la plancha de la maqueta de trenes ( $\varnothing \geq 288$  mm). La plantilla que se adjunta puede resultar útil para lograr un posicionamiento exacto.
3. Montar las vías de enlace necesarias en el puente giratorio y revisar los correspondientes pivotes de confirmación (véanse también las imágenes 5 y 6).
4. Colocar el puente giratorio en la abertura. Ahora se pueden marcar en el tablero los puntos adecuados para las escuadras de fijación.
5. Volver a colocar el puente giratorio en el lateral y atornillar las escuadras de fijación al borde de la abertura (tornillos pre-perforados).
6. Conectar eléctricamente el puente giratorio.
7. Montar el puente giratorio e interconectarlo a las vías previstas.

**La plataforma giratoria debe estar montada de forma flotante, libre de obstáculos y nivelada.**

## Mantenimiento

El puente giratorio 66861 está exento de mantenimiento.

## Empleo

Está preconfigurada la dirección 225 (DCC).

El puente giratorio se puede equipar con un máximo de 2 grupos de 15 vías de enlace. Partiendo de la vía 1 están numeradas secuencialmente en el sentido de las manecillas del reloj las vías de enlace posibles (página 5, imagen 8). Después de haber predefinido el sentido de giro es posible saltar a través de las distintas vías bien directamente o paso a paso. El cambio de polaridad se realiza al cambiar entre las vías 8 y 9 o bien entre las vías 23 y 24.

Los comandos introducidos son confirmados por el puente transbordador emitiendo diferentes pitidos.

Entrada de comando normal Pitido

Programación correcta Pitido Pitido Pitido 

Error Pitido Pitido Pitido 

## Funcionamiento con la Central Station 3

El puente giratorio 66861 debe darse de alta, al igual que otros artículos accesorios aptos para mfx, mediante la función „Buscar artículo mfx“. A continuación, se debe definir la vía 1 y se debe inicializar el puente transbordador.

## Funcionamiento con la Central Station 2

En primer lugar, se debe dar de alta el puente giratorio mediante la función „Buscar artículos mfx“ en el keyboard (keyboard, Configuración, tecla ). A continuación, se puede definir inmediatamente la vía 1 y se debe inicializar el puente transbordador.

## Funcionamiento con el pupitre de mando de señales 72760 (modo analógico)

Es posible el funcionamiento analógico limitado con el pupitre de mando de señales (Märklin) 72760. Para ello, el decóder se debe cambiar al modo MM (dirección 255) con una CS2/CS3. La especificación de vía 1, la inicialización y el salto desde determinadas vías no son posibles.

Para la conexión del puente giratorio al pupitre de posicionamiento de agujas se puede utilizar el cable E242325. Sin embargo, para tal fin se debe seccionar el conector más pequeño (¡lado de la señal!). Para el funcionamiento con el pupitre de posicionamiento de agujas 72760 se debe programar en la dirección 1 el puente giratorio (p. ej., con una Central Station) (¡no es posible una reprogramación con el pupitre de posicionamiento de agujas!).

### Programar el puente transbordador con 72760 a la dirección 1

La programación aquí descrita funciona siempre, independientemente de qué dirección se haya configurado al comienzo. La programación comienza aproximadamente un segundo después de conectar la tensión.

Activar tecla 1 → Desactivar tecla 1 →  
Activar tecla 2 → Desactivar tecla 2 →  
Activar tecla 3 → Desactivar tecla 3 →  
Activar tecla 4 → Desactivar tecla 4

Con la secuencia inversa (Activar tecla 4, Desactivar tecla 4, ...), es posible resetear el puente transbordador a la dirección 225.

## Definir la propia vía 1

1. desplazamiento a la vía 1 deseada
2. Desconectar la maqueta de trenes („STOP“ en la unidad de control)
3. Conectar de nuevo la maqueta de trenes y pulsar antes de transcurridos 5 segundos las teclas <clear><input><clear>

Nota: Mientras esté abierto el enclavamiento de la plataforma giratoria, el puente giratorio no admite comandos de maniobra.

## Inicialización































En la inicialización, el puente giratorio recorre una vez todo el círculo y lee las vías de enlace instaladas. De este modo, durante su funcionamiento, el puente giratorio se detiene tan solo en las vías de enlace realmente existentes.

Si se ha modificado la disposición de las vías de enlace o vías ciegas en el puente giratorio, es preciso reinicializar el puente giratorio.

La inicialización puede realizarse en un margen de 5 segundos después de haber conectado el puente mediante las teclas <end><input><end>

## Funcionamiento en DCC

El carro transbordador 66861 está preconfigurado para el funcionamiento en modo DCC / mfx. Se puede reprogramar a funcionamiento en MM. Pero esto es posible únicamente con la Central Station 2 / 3 en mfx. El carro transbordador se puede resetear de nuevo solo de este modo. La reprogramación para el funcionamiento con el pupitre de mando 72760 **no** es posible en DCC.

CS2*/CS3	(CS2)*	72760	MS2 dirección	Funktion
	end		225	El movimiento de giro finaliza en la vía siguiente
	input	Tecla 1	225	Desenclavamiento/enclavamiento de la plataforma (encendida = desenclavamiento)
	clear		226	Continuar después de STOP
	turn	Tecla 2	226	Giro en 180°
	step 	Tecla 4	227	La plataforma gira hasta la siguiente vía en el sentido de las manecillas del reloj
	step 	Tecla 3	227	La plataforma gira hasta la siguiente vía en sentido contrario al de las manecillas del reloj
			228	Preselección de sentido de giro en el sentido de las manecillas del reloj
			228	Preselección del sentido de giro en el sentido contrario al de las manecillas del reloj
**			229 – 236	Vía destino a la cual se desea efectuar el desplazamiento
			236	Sonido: Locución para operario responsable del carro transbordador
			237	Desactivar sonido de explotación
			237	Activar sonido de explotación
			238	Señal de sonido: ‚Acercar la (loco)‘
			238	Señal de sonido: ‚Alejar la (plataforma giratoria)‘
			239	Apagar luces (interiores)
			239	Encender luces (interiores)
			240	Apagar luces (exteriores)
			240	Encender luces (exteriores)

\* La visualización en la CS2 depende de la versión de software de la CS2

\*\* En la CS3 es posible efectuar el desplazamiento a las distintas vías tocando la vía deseada en cuestión en la pantalla. No se han previsto teclas especiales.

Nota: Mientras esté abierto el enclavamiento de la plataforma giratoria, el puente giratorio no admite comandos de maniobra.

## Avvertenze di sicurezza

- soltanto per un utilizzo in luoghi asciutti
- **ATTENZIONE!** Spigoli e punte acuminati per necessità funzionali.
- I LED incorporati corrispondono alla classe di Laser 1 in base alla normativa EN 60825-1.

## Avvertenze generali

- Tali istruzioni di azionamento costituiscono parte integrante del prodotto e devono pertanto venire conservate nonché consegnate accluse in caso di cessione ad altri di tale prodotto.
- Smaltimento: [www.maerklin.com/en/imprint.html](http://www.maerklin.com/en/imprint.html)

## Funzioni

La piattaforma girevole 66861 è utilizzabile tanto in caso di esercizio di marcia analogico, quanto anche in caso di **esercizio di marcia digitale**. Per il funzionamento della piattaforma girevole stessa è necessario un apparato di comando digitale aggiuntivo (mfx oppure DCC). Un proprio collegamento di tensione per la piattaforma girevole non viene richiesto.

Nelle condizioni di fornitura sono previsti 2 x 3 binari di connessione. Con il corredo di ampliamento 66871 la piattaforma girevole può venire trasformata sino al max. a 30 binari di connessione (griglia di 12°).

## Ampliamenti

I segmenti di bordo della piattaforma girevole possono venire scambiati tra loro a piacere e consentono pertanto un adattamento ottimale al desiderato impianto di binario (Rimozione verso l'alto di un segmento di bordo dalla piattaforma girevole, si veda pagina 4, figura 4).

Con l'ampliamento 66871 la piattaforma può venire ampliata con degli ulteriori binari di connessione. Questi binari di connessione possono anche venire conformati con l'elemento terminale 62001 formando un binario cieco fedele al prototipo. La rimessa locomotive a rotonda (Märklin) 72886 può venire adeguatamente collocata vicino alla piattaforma girevole.

## Collegamento

La piattaforma girevole ha una sua connessione per il comando della piattaforma girevole con un apparato di comando digitale (ad es. Central Station 2 / 3) nonché un collegamento al binario per l'alimentazione del binario sul ponte girevole (pag. 2, figura 1).

I binari di connessione della piattaforma girevole vengono alimentati solo attraverso i binari sull'impianto. L'alimentazione dei binari di connessione attraverso il ponte girevole non è possibile.

## Montaggio

La piattaforma girevole è prevista per il montaggio incassato nell'impianto. A tale scopo nella plancia di base è necessaria una cavità di forma circolare con un **diametro come minimo di 288 mm** ed un' **altezza minima** necessaria per il funzionamento **di 38 mm** (pagina 3, figura 2). Vi sono acclusi 6 angolari di materiale sintetico, i quali vengono fissati sul bordo dell'apertura (pagina 3, figura 3). La piattaforma girevole viene allora collocata sopra questi angolari. Gli angolari devono venire piazzati cosicché essi siano disposti ciascuno **centralmente** sotto un binario cieco o di accesso.

Vogliate prestare attenzione al fatto che la piattaforma girevole installata dovrà essere accessibile da sotto.

1. Selezionare sull'impianto un punto adatto per la piattaforma girevole (abbastanza spazio anche verso il basso; la piattaforma girevole dovrà essere accessibile da sotto).
2. Fresare la cavità nella plancia dell'impianto ( $\varnothing \geq 288$  mm). L'acclusa dima può essere assai utile per l'esatto posizionamento.
3. Applicare alla piattaforma girevole i binari di connessione necessari e verificare le corrispondenti spine di riscontro (si vedano anche le figure 5 & 6).
4. Alloggiare la piattaforma girevole nella cavità. Adesso possono venire marcati sulla plancia i punti adeguati per gli angolari di fissaggio.
5. Collocare nuovamente la piattaforma girevole sul fianco ed avvitare gli angolari di fissaggio sul bordo della cavità (viti preforate).
6. Collegare elettricamente la piattaforma girevole.
7. Installare la piattaforma girevole e collegarla con i binari previsti.

**La piattaforma girevole deve essere montata flottante, libera da vincoli e in piano!**

## Manutenzione

La piattaforma girevole 66861 è esente da manutenzione.



## Esercizio

È preventivamente impostato l'indirizzo 225 (DCC).

La piattaforma girevole può venire equipaggiata con al massimo 2 x 15 binari di connessione. Incominciando dal binario 1, i possibili binari di connessione sono numerati sequenzialmente nel senso delle lancette dell'orologio (pagina 5, figura 8). Dopo che inizialmente è stato specificato il senso di rotazione, ai singoli binari si può a scelta saltare direttamente oppure passo per passo.

La commutazione della polarità del binario avviene durante il trasferimento tra i binari 8 e 9 o rispettivamente tra 23 e 24.

Gli inserimenti vengono riconosciuti dalla piattaforma girevole tramite differenti suoni di Bip.

inserimento normale	Bip	
Programmazione eseguita con successo	Bip Bip Bip	
Errore	Bip Bip Bip	

## Esercizio con la Central Station 3

La piattaforma girevole 66861, come altri apparati accessori adatti per mfx, deve essere registrata mediante la funzione „ricerca apparati mfx“. Dopo di ciò il binario 1 deve venire determinato e la piattaforma girevole venire inizializzata.

## Esercizio con la Central Station 2

La piattaforma girevole viene dapprima registrata nella tastiera mediante la funzione „ricerca apparati mfx“ (keyboard, Configurazione, Tasto ). Dopo di ciò il binario 1 può venire immediatamente determinato e la piattaforma girevole venire inizializzata.

### **Esercizio con il quadro di comando per segnali 72760 (esercizio analogico)**

L'esercizio analogico con limitazioni è possibile con il quadro di comando segnali (Märklin) 72760. A tale scopo il Decoder deve venire convertito all'esercizio MM (indirizzo 255) con una CS2/CS3. La determinazione del binario 1, l'inizializzazione ed il salto a particolari binari non sono possibili.

Per la connessione della piattaforma girevole al quadro di comando può venire utilizzato il cavetto E242325. A questo scopo deve comunque venire tagliata la spina più piccola (dal lato segnale!). Per il funzionamento con il quadro di comando 72760, la piattaforma girevole deve (ad es. con una Central Station) venire programmata sull'indirizzo 1 (una ri-programmazione con il quadro di comando non è possibile!).

### **Programmazione della piattaforma girevole con 72760 sull'indirizzo 1**

La programmazione qui descritta funziona sempre, in modo uguale qualsiasi indirizzo sia impostato all'inizio. La programmazione incomincia circa un secondo dopo che la tensione viene attivata.

Tasto 1 attivazione → Tasto 1 disattivazione →  
Tasto 1 attivazione → Tasto 1 disattivazione →  
Tasto 1 attivazione → Tasto 1 disattivazione →  
Tasto 1 attivazione → Tasto 1 disattivazione

Con la procedura inversa (Tasto 4 attiva, Tasto 4 disattiva, ...) la piattaforma girevole può venire riportata indietro di nuovo all'indirizzo 225.

### **Specificare il binario 1 stesso**

1. accedere al binario 1 desiderato
2. disattivare l'impianto („STOP“ sull'apparato di comando)
3. attivare nuovamente l'impianto ed entro 5 secondi premere i tasti <clear><input><clear>

Avvertenza: fintanto che il bloccaggio del ponte è aperto, la piattaforma girevole non accetta alcun comando di commutazione in contrasto.

































### **Inizializzazione**

Durante l'inizializzazione la piattaforma girevole circola per una volta attraverso tutto quanto il cerchio e seleziona i binari di connessione. Così nell'esercizio la piattaforma girevole si arresta ancora soltanto ai binari di connessione effettivi. Qualora la disposizione dei binari di connessione alla piattaforma girevole o ciechi venga modificata, la piattaforma girevole deve venire di nuovo inizializzata.

Tale inizializzazione può venire avviata entro 5 secondi dopo l'accensione mediante i tasti <end><input><end>.

### **Esercizio sotto DCC**

La piattaforma girevole 66861 è pre-impostata sul funzionamento sotto DCC / mfx. Essa può venire riprogrammata per MM. Tuttavia questo è possibile solo con la Central Station 2 / 3 sotto mfx. Solo così essa può anche venire di nuovo impostata all'inverso. La riprogrammazione per il funzionamento con il quadro di comando 72760 **non** è possibile sotto DCC.

CS2*/CS3	(CS2)*	72760	MS2 indirizzo	Funzione
	end		225	Il movimento di rotazione viene terminato al prossimo binario
	input	Tasto 1	225	Sblocco / blocco del ponte (accesa = sblocco)
	clear		226	Continua la marcia dopo uno STOP
	turn	Tasto 2	226	Rotazione di 180°
	step 	Tasto 4	227	Il ponte ruota sino al prossimo binario in senso orario
	step 	Tasto 3	227	Il ponte ruota sino al prossimo binario in senso antiorario
			228	Preselezione del senso di rotazione in senso orario
			228	Preselezione del senso di rotazione in senso antiorario
**			229 – 236	Binario di arrivo a cui si deve accedere
			236	Rumore: Annuncio assistente alla piattaforma girevole
	16 		237	Rumori di esercizio spenti
	17 		237	Rumori di esercizio attivi
	18 		238	Segnale sonoro: „(Locomotiva) avvicinarsi“
	19 		238	Segnale sonoro: „(Piattaforma) andare via“
	20 		239	Luce spenta (interna)
	21 		239	Luce accesa (interna)
	22 		240	Luce spenta (esterna)
	23 		240	Luce accesa (esterna)
	24 		240	Luce accesa (esterna)

\* la raffigurazione sulla CS2 è dipendente dalla versione Software della CS2

\*\* Nella CS3 può venir dato accesso ai binari tramite il tocco del binario desiderato sullo schermo visore. Non è previsto alcun tasto particolare.

Avvertenza: fintanto che il bloccaggio del ponte è aperto, la piattaforma girevole non accetta alcun comando di commutazione in contrasto.

## Säkerhetsanvisningar

- Får endast användas i torra utrymmen inomhus
- **WARNING!** Funktionsbetingade vassa kanter.
- Inbyggda LED-lampor motsvarar laserklass 1 enligt Norm EN 60825-1.

## Allmänna anvisningar

- Bruksanvisningen tillhör produkten och måste därför sparas och medfölja produkten vid eventuell överlåtelse till annan person.
- Hantering som avfall: [www.maerklin.com/en/imprint.html](http://www.maerklin.com/en/imprint.html)

## Funktioner

Vändskiva 66861 kan användas för **körning med analog eller digital drift**.

För drivning av själva vändskivan krävs ett digitalt körreglage (som kan hantera mfx eller DCC). Det krävs inget extra nätaggregat för att driva vändskivan.

Vid leveransen är vändskivan avsedd för 2x3 anslutningsspår. Med utbyggnadssat nr 66871 kan vändskivan byggas ut till max. 30 anslutningsspår (12°-raster).

## Utbyggnad

Vändskivans ringsegment kan bytas ut och flyttas runt för att skapa en optimal anpassning till en önskad spårplan. (Ringsegmenten demonteras rakt uppifrån, se sidan 4 - bild 4.)

Med hjälp av utbyggnadssats 66871 kan vändskivan förses med ännu fler spåranslutningar. Dessa spåranslutningar kan även förses med ändbit 62001 för att ge ett realistiskt intryck av blindspår.

Ringlokstall (Märklin) 72886 passar utmärkt att ställa upp intill vändskivan.

## Anslutning

Vändskivan har en anslutning för styrningen av själva vändskivan med ett digitalt köraggregat (t.ex. Central Station 2 / 3) samt en anslutning för körströmmen till spåret på bryggan (S. 2, bild 1).

Vändskivans spåranslutningar matas endast med strömmen från anläggningen. Matning till spåranslutningarna via vändskivans brygga kan inte göras.

## Montering

Vändskivan är avsedd att monteras nedsänkt i anläggningen. Därför behövs en runt hål med **minst 288 mm diameter** och med ett fritt djup på **minst 38 mm** för att drivningen ska få plats (Sidan 3, bild 2). De sex medföljande plastvinklarna ska fästas i kanterna (Sida 3, bild 3). Vändskivan läggs sedan ovanpå dessa vinklar. Vinklarnas placering måste vara fördelad så att varje vinkel hamnar **mitt under** varsitt blind- eller anslutningsspår.

Tänk på att vändskivan behöver vara åtkomlig underifrån efter monteringen.



1. Välj en lämplig plats för vändskivan på anläggningen (tänk på att ha tillräckligt med utrymme under vändskivan också, då man måste ha åtkomst underifrån efter monteringen.)
2. Gör hålet som krävs för monteringen ( $\varnothing \geq 288$  mm). Den bifogade mallen kan underlätta den exakta placeringen.
3. Anslut de önskade anslutningsspåren till vändskivan och kontrollera respektive tappor (se även bild 5 & 6).
4. Placera vändskivan i hålet. Nu kan de exakta positionerna för monteringsvinklarna markeras på anläggningen.
5. Lägg vändskivan åt sidan igen och fäst monteringsvinklarna vid kanten på hålet (Förborrade skruvar).
6. Anslut vändskivans elektriska kontakter.
7. Montera vändskivan i hålet och anslut de önskade spåren

**Skivspelaren måste monteras flytande, fri från begränsningar och nivå!**

## Underhåll

Vändskiva 66861 är underhållsfri.

## Drift



Adress 225 (DCC) är förinställd

Vändskivan kan utrustas med maximalt 2 x 15 anslutningsspår. Spåren numreras medurs med start på spår 1 (Sida 5, bild 8).

Efter att man valt rotationsriktning kan man välja att hoppa till destinationsspåret direkt eller om man vill rotera stegvis.

Omkastning av rälsens polaritet sker vid växling mellan spår 8 och 9, t.ex. mellan 23 och 24.

Vändskivan kvitterar givna order genom olika ljud/pip-toner.

normala order	Pip	
programmering lyckades	Pip Pip Pip	
fel	Pip Pip Pip	

### Drift med Central Station 3

Vändskiva 66861 måste precis som andra mfx-tillbehör läggas till genom att "söka mfx-artikel". Därefter måste Spår 1 fastställas och vändskivan initialiseras.

### Drift med Central Station 2

Vändskivan läggs sedan till genom funktionen "sök mfx-artikel" i keyboard (keyboard, konfigurera, knapp ) Därefter kan Spår 1 omedelbart fastställas och vändskivan initialiseras.initialisiert werden.

### Körning med Signal-ställpult 72760 (Analog drift)

Begränsad analog körning kan göras via signal-ställpult (Märklin) 72760. I så fall måste dekodern, med hjälp av en CS2/CS3, ställas om till MM-drift (adress 255). Inställning av anslutningsspår 1, spåridentifiering och den automatiska körningen till olika bestämda spår kan ej göras.

För att ansluta vändskivan till ställpulten kan man använda kabel E242325. Man måste dock kapa bort den lilla kontakten (signalsidan!) för att det ska fungera. För drift med ställpult 72760 måste vändskivan programmeras till adress nr 1 med hjälp av t.ex. Central Station. (Programmering kan inte göras med ställpulten!)

### Programmering med 72760 på Adress 1

Den här beskrivna programmeringen fungerar alltid, oavsett vilken adress man ställt in från början. Programmeringen börjar efter cirka en sekund efter att spänningen kopplas på.

Knapp 1 inkoppling → Knapp 1 urkoppling →  
Knapp 1 inkoppling → Knapp 1 urkoppling →  
Knapp 1 inkoppling → Knapp 1 urkoppling →  
Knapp 1 inkoppling → Knapp 1 urkoppling

Mit dem Umgekehrten Ablauf (Taste 4 an, Taste 4 aus, ...) kann die Drehscheibe wieder auf die Adresse 225 zurück gestellt werden.

Med knapptryckningar i omvänd ordning (Knapp 4 inkoppling, Knapp 4 urkoppling...) kan vändskivan åter ställas in på digitaladressen 225.

### Programmering av spåranslutning 1

1. manövrera till önskat läge för spåranslutning 1
2. stäng av anläggningens ström ("STOPP" på körkontrollen)
3. aktivera strömmen igen och tryck inom 5 sekunder på knapparna <clear><input><clear>

Observera: Så länge lokbryggan inte är i låst position så tar vändskivan inte emot några kommandon.

































### Spåridentifiering

Vid spåridentifiering roterar vändskivan ett helt varv och läser av alla spåranslutningar. Sedan kommer vändskivan endast att kunna manövreras till de identifierade spåranslutningarna. Om man flyttar, lägger till eller tar bort spåranslutningar eller blindspår måste en ny spåridentifiering genomföras.

Spåridentifieringen startas genom att trycka på knapparna <end><input><end> inom 5 sekunder från det att anläggningens ström aktiveras.

### Körning med DCC

Vändskivan 66861 är förinställd för körning med DCC / mfx. Den kan programmeras om för körning med MM. Detta kan endast göras med hjälp av Central Station 2 / 3, via mfx. Återställning av programmeringen kan endast göras på samma sätt. Omprogrammering för körning med ställpult 72760 kan **INTE** göras vid körning med DCC.

CS2*/CS3	(CS2)*	72760	MS2 adress	Funktion
	end		225	Rotationen stannar vid nästa spåranslutning
	input	Knapp 1	225	Lås / Frigör lokbryggan (på = lås)
	clear		226	Kör vidare efter STOP
	turn	Knapp 2	226	Rotera 180°
	step 	Knapp 4	227	Lokbryggan roterar till nästa spåranslutning medurs
	step 	Knapp 3	227	Lokbryggan roterar till nästa spåranslutning moturs
			228	Förval av rotationsriktning medurs
			228	Förval av rotationsriktning moturs
**			229 – 236	Önskad spåranslutning som skall manövreras till
			236	Ljudeffekt: Meddelande från vändskivekontrollen
	16 		237	Driftsljud kopplas ur
	17 		237	Driftsljud kopplas på
	18 		238	Ljudsignal: „(lok) kommer“
	19 		238	Ljudsignal: „(bryggan) rör sig“
	20 		239	Ljus av (inne)
	21 		239	Ljus på (inne)
	22 		240	Ljus av (ute)
	23 		240	Ljus på (ute)
	24 			

\* omställningen via CS2 är beroende av CS2:ans software-version

\*\* Vid körning med CS3 kan man manövrera vändskivan genom att klicka direkt på önskad spåranslutning på bildskärmen. Det finns inga specialknappar för detta.

Observera: Så länge lokbryggan inte är i låst position så tar vändskivan inte emot några kommandon.

## Sikkerhedsvejledning

- Må kun anvendes i lukkede rum.
- **ADVARSEL!** Funktionsbetingede skarpe kanter og spidser kan forekomme.
- Indbyggede LEDer svarer til laserklasse 1 iht. EN 60825-1.

## Generel vejledning

- Betjeningsvejledningen er del af leveringsomfanget og skal derfor altid opbevares og videregives sammen med produktet.
- For bortskaffelse se: [www.maerklin.com/en/imprint.html](http://www.maerklin.com/en/imprint.html)

## Funktioner

Drejeskive 66861 kan både bruges til analog og **digital kørsel**. Til drift af selve drejeskiven skal der bruges en selvstændig digital styreenhed (mfx eller DCC). Separat spændingstilslutning til drejeskiven er ikke nødvendig.

Ved udlevering er der påregnet 2 x 3 tilslutningsspor. Med udvidelsessæt 66871 kan drejeskiven udvides til maks. 30 tilslutningsspor (12°-raster).

## Tilføjelser

Drejeskivens kantsegmenter kan udskiftes, hvilket muliggør optimal tilpasning til det ønskede sporanlæg (kantsegmentet løftes op og ud af drejeskiven, side 4, ill. 4).

Med udvidelse (Märklin) 66871 kan der tilføjes flere tilslutningsspor til drejeskiven. Tilslutningssporene kan også forsynes med endestykke 62001 og laves til et blindspor. Lokomotivskur 72886 kan passende stilles op ved siden af drejeskiven.

## Tilslutning

Drejeskiven har en tilslutning til styring af drejeskiven med en digital styreenhed (f.eks. Central Station 2/3) samt en sportilslutning til forsyning af sporet på drejerampen (side 2, ill. 1).

Drejeskivens tilslutningsspor forsynes kun via anlæggets spor. Det er ikke muligt at forsyne tilslutningssporene via drejerampen.

## Montering

Drejeskiven er fremstillet til forsænket indbygning i anlæget. Dertil laves en rund udsparring i grundpladen med en **diameter på mindst 288 mm** og en min. **højde på 38 mm**, som er påkrævet til driften (side 3, ill. 2). Der er vedlagt 6 plastikvinkler, som fastgøres på åbningens kant (side 3, ill. 3). Drejeskiven lægges derefter på vinklerne. Vinklerne skal placeres således, at de ligger **midt** under et blind- eller tilkørselsspor.

Bemærk, at den indbyggede drejeskive skal være tilgængelig nedefra.

1. Vælg et egnet sted til drejeskiven på anlægget (der skal være tilstrækkelig plads nedenunder; drejeskiven skal være tilgængelig nedefra).
2. Fræs udsparinger i anlægspladen ( $\varnothing \geq 288$  mm). Vedlagte skabelon kan bruges til præcis placering.
3. Forbind tilslutningssporene med drejeskiven og kontrollér de pågældende anmodningstapper (se også ill. 5 & 6).
4. Læg drejskiven i udsparingen. Nu kan det egnede sted til fastgørelsesvinklerne markeres på pladen.
5. Læg drejeskiven til side og skru vinklerne fast på udsparingens kant (Forbor skrues).
6. Tilslut drejskiven elektrisk.
7. Sæt drejskiven fast og forbind den med de ønskede spor.

**Pladespilleren skal være flydende, ubegrænset og jævnt monteret!**

### Vedligeholdelse

Drejeskive 66861 er vedligeholdelsesfri.



### Drift

Adressen 225 (DCC) er indstillet på forhånd.

Det er muligt at tilføje maks. 2 x 15 tilslutningsspor til drejeskiven. Startende med spor 1 er de mulige tilslutningsspor gennemnummereret med uret (side 5, ill. 8). Efter at have fastlagt drejeretningen, kan de enkelte spor vælges direkte eller trinvis.

Skift af sporpolariteten sker ved skift mellem sporene 8 og 9 hhv. mellem 23 og 24.

Indtastninger kvitteres af drejeskiven med forskellige bippelyde.

normal indtastning	bip	
succesfuld programmering	bip bip bip	
fejl	bip bip bip	

### Drift med Central Station 3

Drejeskive 66861 skal ligesom andre mfx-kompatible tillægsartikler registreres via funktionen "søg mfx-artikler". Herefter skal spor 1 defineres, og drejeskiven skal initialiseres.

### Drift med Central Station 2

Drejskiven registreres først via funktionen "søg mfx-artikler" på keyboardet (keyboard, konfiguration, taste ). Herefter kan spor 1 straks defineres, og drejeskiven kan initialiseres.

### Drift med signal-styrepult 72760 (analog drift)

Den indskrænkede analogdrift med signal-styrepulsten (Märklin) 72760 er mulig. Hertil skal dekoderen sættes til MM-drift (adresse 255) med en CS2/CS3. Det er ikke muligt at bestemme spor 1, initialisere og vælge bestemte spor.

Kabel E242325 kan bruges til forbindelse af drejeskiven med kontrolpanelet. Det kræver dog, at det lille stik (signalside!) skæres af. Til drift med kontrolpanel 72760 skal drejeskiven programmeres på adresse 1 (f. eks. med en Central Station). Omprogrammering er ikke mulig med kontrolpanelet!

### Programmering af drejeskive med 72760 til adresse 1

Den her beskrevne programmering fungerer altid, lige meget, hvilken adresse der er indstillet i begyndelsen. Programmeringen begynder cirka et sekund efter at der er blevet tændt for spændingen.

Tænd tast 1 → sluk tast 1 →

Tænd tast 2 → sluk tast 2 →

Tænd tast 3 → sluk tast 3 →

Tænd tast 4 → sluk tast 4

Med det omvendte forløb (tænd tast 4, sluk tast 4, ...) kan drejeskiven igen indstilles tilbage til adresse 225.

### Manuel bestemmelse af spor 1

1. Kør hen på det ønskede spor 1.
2. Sluk anlægget ("STOP" på styreenheden).
3. Tænd anlægget og tryk på <clear><input><clear> indenfor 5 sekunder.































Bemærk: Så længe ramperne er åbne, kan drejeskiven ikke modtage ordrer.

### Initialisering

Ved initialisering kører drejeskiven én gang helt rundt og læser tilslutningssporene ud. Således forbliver drejeskiven under drift kun stående foran de faktiske tilslutningsspor. Hvis tilslutnings- eller blindsporenes anordning på drejeskiven er blevet ændret, skal drejeskiven atter initialiseres. Initialiseringen kan startes indenfor 5 sekunder efter start ved hjælp af tasterne <end><input><end>.

### Drift i DCC

Drejeskiven 66861 er på forhånd indstillet til drift med DCC / mfx. Den kan omprogrammeres til MM. Dette er dog kun muligt med Central Station 2 / 3 med mfx. Indstillingen kan også kun skiftes tilbage på denne måde. En omprogrammering til brug med styreapparatet 72760 er **ikke** muligt med DCC.

CS2*/CS3	(CS2)*	72760	MS2 adressen	Funktion
	end		225	Drejebevægelse afsluttes ved næste spor
	input	taste 1	225	Åbn/lås ramperne (tænd = åbn)
	clear		226	Kør videre efter STOP
	turn	taste 2	226	180° drejning
	step 	taste 4	227	Rampe drejer med uret indtil næste spor
	step 	taste 3	227	Rampe drejer mod uret til næste spor
			228	Forindstilling drejeretning med uret
			228	Forindstilling drejeretning mod uret
**			229 – 236	Målspor, der køres efter
			236	Lyd: Meddelelse drejeskivevogter
			237	Driftslyd sluk
			237	Driftslyd tænd
			238	Lydsignal: „(Lokomotiv) nærmer sig“
			238	Lydsignal: „(Bro) køres væk“
			239	Lys slukket (indendørs)
			239	Lys tændt (indendørs)
			240	Lys slukket (udendørs)
			240	Lys tændt (udendørs)

\* visningen på CS2 afhænger af softwareversionen i denne CS2

\*\* I CS3 kan sporene vælges ved hjælp af berøring af det ønskede spor på displayet. Der er ikke særlige taster til dette.

Bemærk: Så længe ramperne er åbne, kan drejeskiven ikke modtage ordrer.







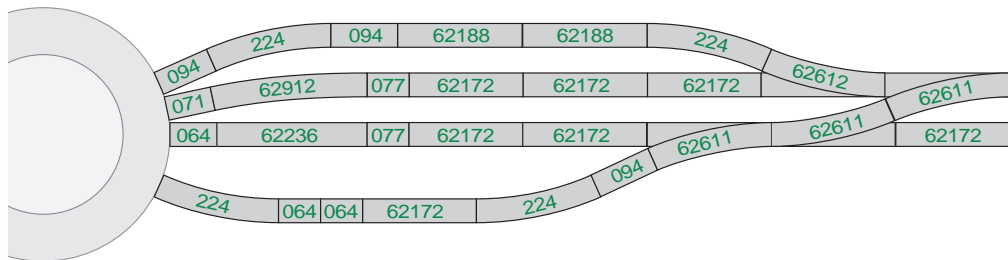
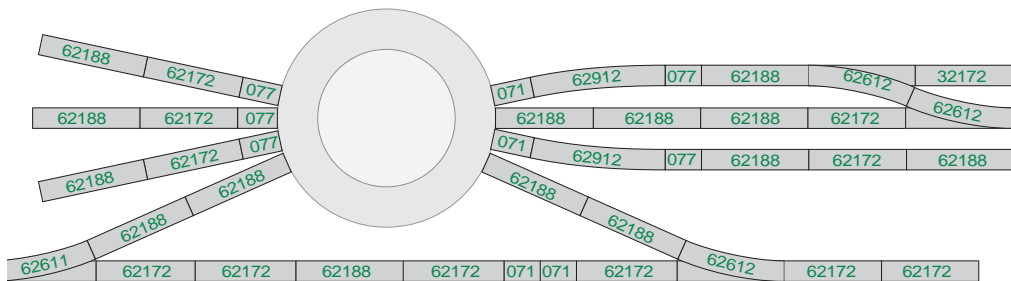

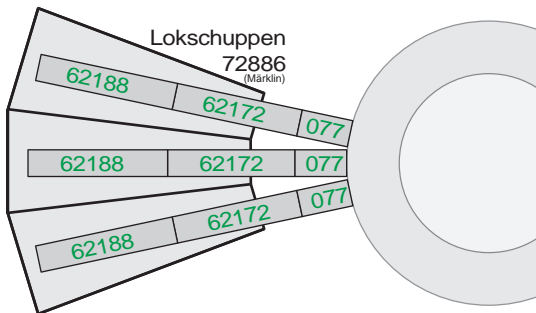
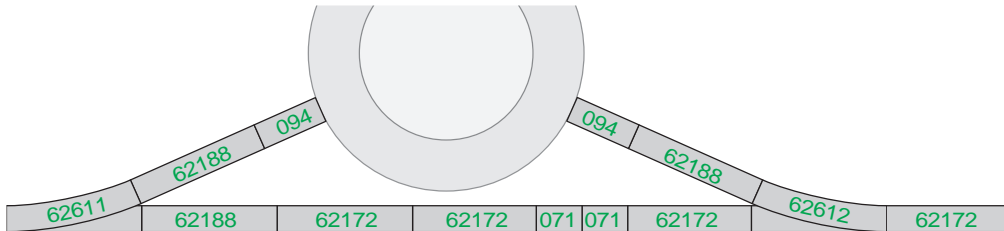

Gebr. Märklin & Cie. GmbH  
Stuttgarter Straße 55 - 57  
73033 Göppingen  
Germany  
[www.trix.de](http://www.trix.de)



  
[www.maerklin.com/en/imprint.html](http://www.maerklin.com/en/imprint.html)

260287/0521/Sm1Ef  
Änderungen vorbehalten  
© Gebr. Märklin & Cie. GmbH