

märklin
H0

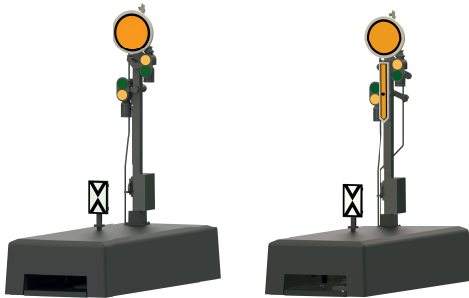

Vorsignal
70362 / 70382

Inhaltsverzeichnis	Seite
Bestimmungsgemäße Verwendung	4
Lieferumfang	4
Sicherheitshinweise	4
Wichtige Hinweise	4
Technische Daten	4
Funktionen	4
Signal-Einbau	4
Programmierung mit CS 2 / CS 3	5
Programmierung mit MS 2	5
Betrieb unter mfx	6
Betriebsart und Adressen einstellen	28
Aufbau	39
Aufkleber anbringen	48
Bohrschablone	49

Table of Contents	Page
Intended Use of the Product	7
Contents as Delivered	7
Safety Notes	7
Important Notes	7
Technical Data	7
Functions	7
Signal Installation	7
Programming with the CS 2 / CS 3	8
Programming with the MS 2	8
Operation with mfx	9
Setting the mode of operation and addresses	28
Setup	39
Attach decals	48
Drilling Template	49

Sommaire	Page
Utilisation conforme	10
Livraison	10
Consignes de sécurité	10
Consignes importantes	10
Caractéristiques techniques	10
Fonctions	10
Montage du signal	10
Programmation avec CS 2 / CS 3	11
Programmation avec MS 2	11
Exploitation sous mfx	12
Définir le mode d'exploitation et les adresses	28
Montage	39
Fixez les autocollants	48
Gabarit de perçage	49

Inhoudsopgave	Pagina
Beoogd gebruik	13
Leveringsomvang	13
Veiligheidsvoorschriften	13
Belangrijke aanwijzingen	13
Technische gegevens	13
Functies	13
Sein inbouwen	13
Programmeren met CS 2 / CS 3	14
Programmeren met MS 2	14
Bedrijf met mfx	15
Bedrijfsmodus en adres instellen	28
Opbouwen	39
Bevestig stickers	48
Boorsjabloon	49

Indice de contenido	Página	Innehållsförteckning	Sidan
Uso previsto	16	Användningsområde	22
Alcance de suministro	16	Innehåll	22
Instrucciones de seguridad	16	Säkerhetsföreskrifter	22
Consejos importantes	16	Viktig information	22
Datos técnicos	16	Tekniska data	22
Funciones	16	Funktioner	22
Montaje de la señal	16	Signal-inbyggnad	22
Programación con CS 2 / CS 3	17	Programmering med CS 2 / CS 3	23
Programación con la MS 2	17	Programmering med MS 2	23
Funcionamiento en modo mfx	18	Körning med mfx	24
Configuración de modo de funcionamiento y direcciones	28	Ställ in driftstyp och adress	28
Montaje	39	Montering	39
Allega decalcomanie	48	Bifoga dekaler	48
Plantilla	49	Borrschablon	49
Elenco del contenido	Página	Indholdsfortegnelse	Side
Impiego commisurato alla destinazione	19	Hensigtsmæssig anvendelse	25
Corredo di forniture	19	Leveringsomfang	25
Avvertenze di sicurezza	19	Sikkerhedsvejledning	25
Avvertenze importanti	19	Vigtig information	25
Dati tecnici	19	Tekniske data	25
Funzioni	19	Funktioner	25
Montaggio del segnale	19	Signalindbygning	25
Programmazione con CS 2 / CS 3	20	Programmering med CS 2 / CS 3	26
Programmazione con MS 2	20	Programmering med MS 2	26
Esercizio sotto mfx	21	Drift med mfx	27
Impostate tipo di funzionamento e indirizzi	28	Indstil driftsart og adresser	28
Montaggio	39	Forsamling	39
Coloque las calcomanías	48	Vedhæft decals	48
Maschera di Foratura	49	Boreskabelon	49

Bestimmungsgemäße Verwendung

- Das Signal ist zum Einbau in H0 Digital-Modellbahn-Anlagen.
- Das Signal darf für den Analogbetrieb nur mit Stellpult 72760 verwendet werden.
- Darf nur in geschlossenen Räumen verwendet werden.

Lieferumfang

- 1 Signal
- 1 Kabel mit Stecker 2 polig, rot und braun
- 2 Haltewinkel zur Unterflurmontage
- 1 Halteplatte C-Gleis
- 7 Signaltafeln
- 1 Steckfuss
- 1 Satz Schiebebilder zur Kennzeichnung
- Einbauanleitung mit Schablone zur Unterflurmontage
- Garantieurkunde

Für die Unterflurmontage zusätzlich benötigtes Werkzeug:
Schraubendreher, 4x Senkkopfschrauben Ø 2,5mm x (Länge abhängig von der Einbautiefe), Bohrer Ø 16mm und 2mm.

Sicherheitshinweise

- **ACHTUNG!** Funktionsbedingte scharfe Kanten und Spitzen.
- Verkabelungs- und Montagearbeiten nur im spannungslosen Zustand ausführen. Bei Nichtbeachtung kann es zu gefährlichen Körperströmen und damit zu Verletzungen führen.
- **Signal nur mit der zulässigen Spannung** (siehe technische Daten) **betreiben**.

Wichtige Hinweise

- Die Bedienungsanleitung ist Bestandteil des Produktes und muss deshalb aufbewahrt sowie bei Weitergabe des Produktes mitgegeben werden.
- Für Reparaturen wenden Sie sich bitte an Ihren Märklin-Fachhändler.
- Entsorgung: www.maerklin.com/en/imprint.html

Technische Daten

- Belastung ≤ 100 mA
- Belastung Gleis Ausgang max. 2 A
- Spannungsfestigkeit max. 40 V

Funktionen

- Multiprotokoll fähig: fx (MM), mfx* und DCC
- Einstellen der Betriebsart mittels DIP-Schalter
- Einstellbare Adressen mit DIP-Schalter:
 - 1-256** fx (MM) (Control Unit 6021)
 - 1-320** fx (MM) (Central Station 6021x/Mobile Station 60653)
 - 1-511** (DCC)
- Programmierbare Adressen über CV
 - 1-2.040** DCC
- Änderungen der Eigenschaften über CV
- Stromversorgung über Digitalstromkreis

Signal-Einbau

Vor dem eigentlichen Einbau muss das Signal programmiert werden.

Folgende Arbeitsschritte dürfen nur im spannungslosen Zustand ausgeführt werden:

* mfx erst ab CS 2 Softwareversion 4.0

Einstellung der Adresse und Betriebsart durch den DIP-Schalter:

- Einstellen der Betriebsart mit DIP-Schalter 10
Schalter 10 off = fx (MM) / mfx
Schalter 10 on = DCC
- fx (MM)/DCC einstellen der Adresse mit DIP-Schalter
(Tabelle ab Seite 28)

Beachten Sie: Einstellungen mit dem DIP-Schalter immer spannungslos vornehmen. Das Signal erkennt erst mit dem Einschalten der Spannung die aktuellen Schalterstellungen.

Programmierung mit CS 2 / CS 3

fx (MM)

Die CV Programmierung muss am Programmiergleis erfolgen. Es darf **immer nur ein Signal** am Programmiergleis angeschlossen werden.

Folgende CV können bei fx (MM) verändert werden: CV 39, 40, 41 und 42. Bei den CV 41 und 42 muss bei fx (MM) der Wert durch 4 geteilt werden, denn es sind Werte 0-80 zulässig z.B. $255/4 = 64$ (gerundet).

Während des Programmiervorganges blinkt die Signallampe, abweichend davon wird während des programmierens mit der Central Station das Signal geschaltet. Nach Abschluss des Programmiervorganges wird das Signal auf „Fahrt“ gestellt.

Die Vorgehensweise beim Programmieren mit der Control Unit 6021 finden Sie auf www.maerklin.de -> Service -> Technische Informationen.

Die Programmierung mit anderen Geräten, entnehmen Sie bitte der Bedienungsanleitung des jeweiligen Steuergerätes.

DCC

Die CV Programmierung muss am Programmiergleis erfolgen. Es darf **immer nur ein Signal** am Programmiergleis angeschlossen werden.

Während der Datenübertragung blinkt zur Kontrolle die Laterne am Signal.

Die Programmierung mit anderen Geräten, entnehmen Sie bitte der Bedienungsanleitung des jeweiligen Steuergerätes.

Programmierung mit MS 2

Zur Programmierung der Signale mit der Mobile Station 2 muss eine neue Lokomotive manuell unter MM2 oder DCC angelegt werden.

Beachten Sie bitte, dass dann das zu programmierende Signal über die Codierschalter auch auf MM2 oder DCC und auf die selbe Adresse wie die Lokomotive eingestellt wurde. Diese neu angelegte Lokomotive wird nur für die Programmierung der Signale benötigt. Gehen Sie dazu im Menü der MS 2 auf „Lok konfigurieren“ und anschließend auf „CV programmieren“. Während des CV-programmierens dürfen keine anderen Lokomotiven, Signale oder Weichendecoder angeschlossen sein.

CV für fx (MM) und DCC

Unter fx (MM) kann die Adresse nur mit dem DIP-Schalter eingestellt werden. Werte in Klammern sind die Werkseinstellungen.

CV	Bedeutung	Werte	
1	Adresse 1 - 255	1-255 (1)	nur DCC
9	Adressen 256 - 2040	0-7 (0)	nur DCC

CV	Bedeutung	Werte	
39	Langsame Bewegung	0 (0)	
PoM*	Mittelschnelle Bewegung	1	
	Schnelle Bewegung	2	
	Mittelschnelle Bewegung mit Nachwippen	3	
	Schnelle Bewegung mit Nachwippen	4	
	Mittelschnelle Bewegung mit Nachwippen Flügel 1	5	nur bei 70382
	Mittelschnelle Bewegung mit Nachwippen Flügel 2	6	nur bei 70382
40	Beleuchtung	0 - 15 (15)	0 licht aus dimmen 0-15, wobei 15 = 100% Helligkeit entspricht
PoM*			
41	Mittelstellung Flügel 1	0 - 255	Einstellung der Mittelposition für den Flügel aller Signale
PoM*			
42	Mittelstellung Flügel 2	0 - 255	nur bei 70382 Einstellung der Mittelposition für den 2. Flügel
PoM*			



*PoM programmieren kann, sofern es vom Steuergerät unterstützt wird, am Hauptgleis erfolgen.

Einstellen und errechnen der Adressen größer 255 (DCC):

Z.B. Adresse 1044 -> $1044:256=4,078125$. Der Wert vor dem Komma (4) ist in CV 9 einzutragen. Der Wert nach dem Komma (0,078125) wird mit 256 multipliziert $0,078125 \times 256=20$. Der errechnete Wert 20 muss in CV 1 eingetragen werden.

Betrieb unter mfx

Die mfx-Anmeldung kann unter MM oder DCC erfolgen. Entscheidend ist die über den Dip-Schalter 10 eingestellte Betriebsart.

Die mfx-Anmeldung wird mit der CS2 60213/60214/60215 in der Magnetartikelkonfiguration über  >  und mit der CS3 60216/60226 in der Magnetartikelkonfiguration über  > „mfx-Artikel suchen“ angestoßen.

Hinweis zur mfx-Anmeldung mit der CS2:

Auswahlmöglichkeit „Magnetartikel automatisch zuweisen“ unter „Setup“ >  > „Gleis“.

Ist dort das Häkchen gesetzt erfolgt die mfx-Anmeldung auf die ersten freien Adressen in der CS2. Ist das Häkchen nicht gesetzt, erfolgt die mfx-Anmeldung auf die tatsächlich am Decoder programmierten Adressen.

Intended Use of the Product

- This signal is for installation on H0 digital model railroad layouts.
- This signal may only be used for analog operation with the 72760 control box.
- Use only in enclosed areas.

Contents as Delivered

- 1 Signal
- 1 Cable with plug, 2-conductor, red and brown
- 2 Mounting brackets for below-baseboard installation
- 1 Mounting for C Track
- 7 Signal signs
- 1 Plug-in base
- 1 Set of decals for identification
- Installation instructions with a template for below-baseboard installation
- Warranty card

Additional tools required for below-baseboard installation: screwdriver, 4 each countersunk screws Ø 2.5 mm x (length dependent on the installation depth), drills Ø 16 mm and 2 mm.

Safety Notes

- **IMPORTANT!** The product has sharp edges and points due to the way it works.
- Do wiring and installation work only when there is no voltage present. Failure to adhere to this may cause life-threatening current and injury.
- **This signal is to be operated only with the permissible voltage** (see technical data).

Important Notes

- The operating instructions are a component part of the product and must therefore be kept in a safe place as well as for transfer of the product to third parties.
- Please see your authorized Märklin specialty dealer for repairs.
- Disposing of the product: www.maerklin.com/en/imprint.html

Technical Data

- Load ≤ 100 milliamps
- Load at the track output max. 2 amps
- Electrical strength max. 40 volts

Functions

- Capable of multi-protocols: fx (MM), mfx*, and DCC
- Mode of operation set by means of DIP switches
- Addresses can be set by means of DIP switches:
 - 1-256** fx (MM) (Control Unit 6021)
 - 1-320** fx (MM) (Central Station 6021x/Mobile Station 60653)
 - 1-511** (DCC)
- Programmable addresses by means of CVs **1-2,040** DCC
- Characteristics can be changed by means of CVs
- Power supplied by means of the digital current circuit

Signal Installation

The signal must be programmed before actually installing it.

The following work steps may be done only when there is no voltage present:

* mfx not until CS 2 Software Version 4.0

Setting the address and the mode of operation with the DIP switches:

- Setting the mode of operation with DIP Switch 10
Switch 10 off = fx (MM) / mfx
Switch 10 on = DCC
- fx (MM)/DCC Setting the address with DIP switches (See table starting on Page 28)

Please note: Always do settings with the DIP switches when there is no voltage present. The signal does not recognize the current switch settings until the voltage is turned on.

Programming with the CS 2 / CS 3

fx (MM)

The CV programming must be done on the programming track. **Only one signal** may be connected to the programming track **at a time**.

The following CVs can be changed in fx (MM): CV 39, 40, 41, and 42. With CVs 41 and 42 the value must be divided by 4 in fx (MM), because only the values 0-80 are allowed, for example:
 $255/4 = 64$ (rounded).

During the programming procedure, the signal light will blink. During programming with the Central Station, by contrast the signal is switched. After the end of the programming procedure, the signal is set at "Go".

The procedure for programming with the 6021 Control Unit can be found at www.maerklin.de -> Service -> Technische Informationen.

Please see the operating instructions for the control devices in question for programming with other devices.

DCC

CV programming must be done on the programming track. **Only one signal** may be connected to the programming track **at a time**.

The light on the signal will blink as a check during the data transmission.

Please see the operating instructions for the control devices in question for programming with other devices.

Programming with the MS 2

A new locomotive must be set up manually under MM2 or DCC in order to program signals with the Mobile Station 2.

Please note that the signal to be programmed is then also set by means of the coding switches to MM2 or DCC and to the same address as the locomotive. This newly set up locomotive is only required for the programming of signals. To do this go in the MS 2 menu to „Configure Locomotive“ and then to „Program CV“.

No other locomotive, signals, or turnout decoders may be connected while the CV(s) are being programmed.

CV for fx (MM) and DCC

With fx (MM) the address can be set only with the DIP switches. The values in parentheses are factory default settings.

CV	Meaning	Values	
1	Address 1 - 255	1-255 (1)	only DCC
9	Addresses 256 - 2040	0-7 (0)	only DCC

CV	Meaning	Values	
39	Slow movement	0 (0)	
PoM*	Medium fast movement	1	
	Fast movement	2	
	Medium fast movement with bouncing	3	
	Fast movement with bouncing	4	
	Medium fast movement with bouncing of Arm 1	5	only with 70382
	Medium fast movement with bouncing of Arm 2	6	only with 70382
40	Meaning Lighting	0 - 15 (15)	0 light off Dimming 0-15, whereby 15 = 100% brightness
PoM*			
41	Center setting for Arm 1	0 - 255	Setting of the middle position for the arm on all signals
PoM*			
42	Center setting for Arm 2	0 - 255	Only with 70382 Setting of the middle position for the 2nd arm
PoM*			

*PoM programming can be done on the main track as long as it is supported by the control device.



Setting and Calculating Addresses Greater than 255 (DCC):

Example: Address 1044 -> $1044 : 256 = 4.078125$. The value before the decimal point (4) is entered in CV 9. The value after the decimal point (0.078125) is multiplied by 256 $0.078125 \times 256 = 20$.

The calculated value of 20 must be entered in CV 1.

Operation with mfx

mfx registration can be done with MM or DCC. The mode of operation that has been set by means of Dip Switch 10 is critical.

The mfx registration is initiated with the 60213/60214/60215 CS2 in  >  and with the 60216/60226 CS3 in the solenoid item configuration by means of  > "search for mfx item".

Note about mfx registration with the CS2:

Selection possibility „Automatically assign solenoid item“ at „Setup“ >  > „Track“.

If the check mark there is checked, the mfx registration is done at the first open address in the CS2. If the check mark is not checked, the mfx registration is done at the address actually programmed on the decoder.

Utilisation conforme

- Le signal est conçu pour être monté sur des circuits ferroviaires miniatures numériques H0.
- Le signal ne doit être utilisé en mode analogue qu'avec un pupitre de commande 72760.
- Ne doit être utilisé que dans une pièce fermée.

Livraison

- 1 signal
- 1 câble avec prise bipolaire, rouge et marron
- 2 équerres de fixation pour montage souterrain
- 1 plaque de maintien voie C
- 7 panneaux de signalisation
- 1 pied
- 1 image à coulisser pour la signalisation
- Instructions de montage avec schéma pour montage souterrain
- Certificat de garantie

Outils supplémentaires requis pour le montage souterrain :
Tournevis, 4x vis à tête fraisée Ø 2,5mm x (la longueur dépendant de la profondeur de montage), perceuse Ø 16mm et 2mm.

Consignes de sécurité

- **ATTENTION !** Le matériel comporte des bords coupants et des pointes.
- Effectuer les travaux de câblage et de montage uniquement lorsque le circuit est hors tension. Dans le cas contraire, vous risquez de vous électrocuter et de vous blesser.
- **Utiliser le signal uniquement avec la tension autorisée** (cf. caractéristiques techniques).

Consignes importantes

- Le mode d'emploi fait partie intégrante du produit. Vous devez donc le conserver et la transmettre avec le produit.
- Pour les travaux de réparation, veuillez vous adresser à votre revendeur Märklin.
- Élimination : www.maerklin.com/en/imprint.html

Caractéristiques techniques

- Charge ≤ 100 mA
- Charge sortie voie max. 2 A
- Rigidité diélectrique max. 40 V

Fonctions

- Multiprotocole : fx (MM), mfx* et DCC
- Réglage du mode de fonctionnement au moyen d'un interrupteur DIP
- Adresses réglables au moyen de l'interrupteur DIP :
1-256 fx (MM) (Control Unit 6021)
1-320 fx (MM) (Central Station 6021x/Mobile Station 60653)
1-511 (DCC)
- Adresses programmables via CV
1-2 040 DCC
- Modification des propriétés via CV
- Alimentation électrique via circuit électrique numérique

Montage du signal

Avant le montage à proprement parler, vous devez programmer le signal.

Vous réaliserez les étapes suivantes uniquement lorsque le circuit est hors tension :

Réglage de l'adresse et du mode de fonctionnement via l'interrupteur DIP :

- Réglage du mode de fonctionnement au moyen d'un interrupteur DIP 10
Interrupteur 10 off = fx (MM) / mfx
Interrupteur 10 on = DCC
- fx (MM)/DCC Réglage de l'adresse via l'interrupteur DIP (tableau à partir de la page 28)

Attention : Effectuer les réglages via l'interrupteur DIP uniquement hors tension. Le signal reconnaît les positions du commutateur dès l'activation de la tension.

Programmation avec CS 2 / CS 3

fx (MM)

La programmation CV doit se faire au niveau de la voie de programmation. Vous ne devez brancher **qu'un seul signal** sur la voie de programmation.

Vous pouvez modifier les CV suivant dans fx (MM) : CV 39, 40, 41 et 42. Pour les CV 41 et 42 vous devez diviser la valeur de fx (MM) par 4 car seules des valeurs de 0-80 sont autorisées, par ex. $255/4 = 64$ (arrondie).

Pendant la programmation, la lampe du signal clignote, et, indépendamment de cela, le signal est couplé à la Central Station pendant la programmation. Une fois la procédure de programmation terminée, le signal est mis sur « circulation ».

Vous trouverez la procédure de programmation au moyen de la Control Unit 6021 à la page www.maerklin.de -> Service -> Technische Informationen (www.marklin.fr/fr/produits/outils/base_donnees_produits.html)

Pour la programmation avec d'autres appareils, veuillez consulter les modes d'emploi des pupitres de commande correspondant.

DCC

La programmation CV doit se faire au niveau de la voie de programmation. ne devez brancher **qu'un seul signal** sur la voie de programmation.

Pendant la transmission des données, la lanterne du signal clignote.

Pour la programmation avec d'autres appareils, veuillez consulter les modes d'emploi des pupitres de commande correspondant.

Programmation avec MS 2

La programmation des signaux avec la Mobile Station 2 nécessite la création manuelle d'une nouvelle locomotive sous MM2 ou DCC. Veuillez tenir compte du fait que le signal à programmer aura alors été paramétré via les commutateurs de codage également sur MM2 ou DCC et sur la même adresse que la locomotive. Cette nouvelle locomotive créée est requise uniquement pour la programmation des signaux. A cet effet, allez dans le menu de la MS 2 sur « Configuration loco », puis sur « Programmation CV ». Pendant la programmation des CV, aucune autre locomotive ni aucun autre signal ou décodeur d'aiguille ne doit être raccordé.

CV pour fx (MM) et DCC

Dans fx (MM), vous pouvez configurer l'adresse uniquement via l'interrupteur DIP. Les valeurs entre parenthèses sont les paramètres d'usine.

CV	Éclairage	Valeur	
1	Adresse 1 - 255	1-255 (1)	uniquement DCC
9	Adresses 256 - 2040	0-7 (0)	uniquement DCC
39	Mouvement lent	0 (0)	
PoM*	Mouvement de vitesse moyenne	1	
	Mouvement rapide	2	
	Mouvement de vitesse moyenne avec mouvement de ressort	3	
	Mouvement de vitesse rapide avec mouvement de ressort	4	
	Mouvement de vitesse moyenne avec mouvement de ressort aile 1	5	uniquement pour 70382
	Mouvement de vitesse moyenne avec mouvement de ressort aile 2	6	uniquement pour 70382
40	Éclairage	0 - 15 (15)	0 lumière éteinte variateur 0-15, 15 = 100% de luminosité
PoM*			
41	Réglage moyen aile 1	0 - 255	Réglage de la position moyenne pour l'aile de tous les signaux
PoM*			
42	Réglage moyen aile 2	0 - 255	uniquement pour 70382 réglage de la position moyenne pour la 2e aile
PoM*			

*Vous pouvez effectuer la programmation PoM, si elle est prise



en charge par le pupitre de commande, sur la voie principale.

Réglage et calcul des adresses supérieures à 255 (DCC) : Par ex. adresse 1044 -> $1044:256=4,078125$. Vous devez reporter la valeur avant la virgule (4) dans CV 9. Multipliez la valeur après la virgule (0,078125) par 256 $0,078125 \times 256=20$. Reportez la valeur calculée 20 dans CV 1.

Exploitation sous mfx

L'enregistrement mfx peut se faire sous MM ou DCC.

C'est le mode d'exploitation défini via le commutateur Dip 10 qui importe ici.

Avec la CS2 60213/60214/60215, l'enregistrement mfx est lancé dans la configuration des articles électromagnétiques via  >  et avec la CS3 60216/60226 dans la configuration des articles électromagnétiques via  > „Rechercher articles mfx“.

Remarque concernant la connexion mfx avec la CS2 :

Sélection possible „Affectation automatique d'un article électromagnétique“ sous „Configuration“ >  > „Voie“.

Si cette possibilité est cochée, l'enregistrement mfx se fait sur les premières adresses libres dans la CS2. Si cette possibilité n'est pas cochée, l'enregistrement mfx se fait sur les adresses réellement programmées sur le décodeur.

Beoogd gebruik

- Het sein is bestemd voor het inbouwen in H0-modelbanen.
- Het sein mag in analogebedrijf alleen in combinatie met het schakelkastje 72760 gebruikt worden.
- Het mag alleen in gesloten ruimtes gebruikt worden.

Leveringsomvang

- 1 Sein
- 1 Kabel met stekker 2-polig rood en bruin
- 2 Hoekhouders voor ondervloermontage
- 1 houderplaat voor C-rail
- 7 Seinbord
- 1 Steekvoet
- 1 Transfer voor herkenning
- Inbouwaanwijzing met sjabloon voor ondervloermontage
- Garantiebewijs

Voor de ondervloermontage zijn daarnaast nog nodig: een schroevendraaier, 4 verzonken schroeven \varnothing 2mm x (lengte afhankelijk van de inbouwdiepte), boor \varnothing 16 mm en 2 mm.

Veiligheidsvoorschriften

- **LET OP!** Heeft vanwege de functionaliteit scherpe kanten en punten.
- Bedrading en montagewerkzaamheden alleen in spanningloze toestand uitvoeren. Als dit niet in acht genomen wordt kunt u gevaarlijke stroomschokken krijgen met de daarmee samenhangende verwondingen.
- **Het sein alleen met de toegelaten spanning** (zie technische gegevens) **gebruiken**.

Belangrijke aanwijzingen

- De gebruiksaanwijzing is een bestandsdeel van het product en dient daarom bewaard en meegegeven worden met het product.
- Voor reparaties kunt u zich tot uw Märklin dealer wenden.
- Verwijderingaanwijzing: www.maerklin.com/en/imprint.html

Technische gegevens

- Belasting ≤ 100 mA
- Belasting railuitgang max. 2 A
- Spanning max. 40 V

Functies

- Multi-protocol geschikt voor: fx (MM) , mfx* en DCC
- Instellen van het bedrijfssysteem met dipschakelaar
- Instelbare adressen met dipschakelaars:
 - 1-256** fx (MM) (Control Unit 6021)
 - 1-320** fx (MM) (Central Station 6021x/ Mobile Station 60653)
 - 1-511** (DCC)
- Programmeerbare adressen via CV
 - 1-2040** DCC
- Veranderen van de eigenschappen via CV
- Stroomvoorziening via digitale stroomkring

Sein inbouwen

Voor het inbouwen moet het sein eerst geprogrammeerd worden.

De volgende werkzaamheden mogen alleen in spanningloze toestand worden uitgevoerd:

* mfx pas vanaf CS 2 softwareversie 4.0

Instellen van het adres en het bedrijfssysteem met dipschakelaar:

- Instellen van het bedrijfssysteem met dipschakelaar 10
Schakelaar 10 off = fx (MM) / mfx
Schakelaar 10 on = DCC
- fx (MM) / DCC instellen van het adres met dipschakelaar
(tabel zie pagina 28)

Let op: instelling met de dipschakelaar altijd in spanningloze toestand uitvoeren. Het sein herkent de actuele instelling pas na het inschakelen van de spanning.

Programmeren met CS 2 / CS 3

fx (MM)

De CV programmering moet op het programmeerspoor worden uitgevoerd. Er mag **altijd maar één sein** op het programmeerspoor zijn aangesloten.

De volgende CV's kunnen bij fx (MM) veranderd worden: CV 39, 40, 41 en 42. Bij de CV's 41 en 42 moet bij fx (MM) de waarde door 4 worden gedeeld omdat alleen waarden van 0-80 toelaatbaar zijn, bijv. $255/4 = 64$ (afgerond).

Tijdens het programmeren knippert het licht van het sein, afwijkend daarvan wordt tijdens het programmeren met het Central Station het sein geschakeld. Na het afsluiten van het programmeren wordt het sein in de stand "veilig" gezet.

De werkwijze voor het programmeren met de Control Unit 6021 vindt u op www.maerklin.de -> Service -> Technische Informationen

De wijze van programmering met andere apparaten vindt u in de gebruiksaanwijzing van het desbetreffende apparaat.

DCC

De CV programmering moet op het programmeerspoor worden uitgevoerd. Er mag **altijd maar één sein** op het programmeerspoor zijn aangesloten.

Tijdens de overdracht van de gegevens knippert het licht van het sein ter controle.

De wijze van programmering met andere apparaten vindt u in de gebruiksaanwijzing van het desbetreffende apparaat.

Programmeren met MS 2

Voor het programmeren van seinen met het Mobile Station 2 moet, onder MM2 of DCC, handmatig een nieuwe locomotief ingevoerd worden.

Let er op dat het te programmeren sein met de codeerschakelaars ook op MM2 of DCC en op hetzelfde adres ingesteld staat als de locomotief. Deze nieuw ingevoerde locomotief wordt alleen gebruikt voor het programmeren van het sein. Ga hiervoor in het menu van het MS2 naar "loc configureren" en aansluitend naar "CV programmeren".

Tijdens het programmeren mogen geen andere locomotieven, seinen of wisseldecoders aangesloten zijn.

CV voor fx (MM) en DCC

Onder fx (MM) kan het adres alleen met de dipschakelaar worden ingesteld. De waarden tussen haakjes zijn de fabrieksinstellingen.

CV	Omschrijving	Waarde	
1	Adres 1 - 255	1-255 (1)	alleen DCC
9	Adres 256 - 2040	0-7 (0)	alleen DCC

CV	Omschrijving	Waarde	
PoM*	39 Langzaam bewegen	0 (0)	
	Middel snel bewegen	1	
	Snel bewegen	2	
	Middel snel bewegen met navippen	3	
	Snel bewegen met navippen	4	
	Middel snel bewegen met navippen arm 1	5	Alleen bij 70382
	Middel snel bewegen met navippen arm 2	6	Alleen bij 70382
PoM*	40 Verlichting	0 - 15 (15)	0=licht uit, dimmen 0-15 waarbij 15 = 100% helderheid
PoM*	41 Middenstand arm 1	0 - 255	Instelling van de middenstand van de arm van alle seinen
PoM*	42 Middenstand arm 2	0 - 255	Alleen bij 70382 Instelling van de middenstand van de 2de arm

* PoM programmeren kan, voor zover het besturingsapparaat dit ondersteund, op het hoofdspoor gebeuren.

Instellen en berekenen van de adressen groter dan 255 (DCC):

Bijv. adres 144 -> $1044:256= 4,078125$. De waarde voor de komma (4) moet in CV 9 ingevoerd worden. De waarde na de komma (0,078125) wordt met 256 vermenigvuldigd, $078125 \times 256 = 20$. De berekende waarde (20) wordt in CV 1 ingevoerd.

Bedrijf met mfx

De mfx aanmelding kan zowel onder MM als onder DCC gebeuren.

Bepalend daarvoor is het ingestelde bedrijfstype met dip-schakelaar 10.

De mfx aanmelding wordt met het CS2 60213/60214/60215 in de magneetartikel configuratie via  >  en met het CS3 60216/60226 in de magneetartikelen configuratie via  > "mfx-artikel zoeken" gestart.

Opmerking t.a.v. mfx aanmelding met het CS2

Keuzemogelijkheid "Magneetartikelen automatisch toewijzen" onder "Setup" >  "Rail".

Als daar het vinkje gezet is, vindt de mfx-aanmelding plaats op de eerste vrije adressen in het CS2. Is het vinkje niet gezet, dan vindt de mfx-aanmelding op het werkelijke, op de decoder geprogrammeerde adres plaats.

Uso previsto

- La señal ha sido concebida para su montaje en maquetas de trenes digitales H0.
- Está permitido utilizar la señal para funcionamiento analógico solo con el panel de mando 72760.
- Está permitido su uso solo en recintos cerrados.

Alcance de suministro

- 1 señal
- 1 cable con conector de 2 polos, rojo y marrón
- 2 escuadras soporte para montaje bajo el suelo
- 1 placa soporte para vía C
- 7 paneles de señal
- 1 zócalo
- 1 juego de indicadores deslizantes para identificación
- Instrucciones de montaje con plantilla para montaje bajo el suelo.
- Documento de garantía

Herramientas también necesarias para el montaje bajo el suelo: destornillador, 4 tornillos de cabeza avellanada Ø 2,5mm x (longitud en función de la profundidad de montaje), brocas de Ø 16 mm y 2 mm.

Instrucciones de seguridad

- **¡ATENCIÓN!** Por su funcionalidad, incluye aristas cortantes y puntas.
- Realizar los trabajos de cableado y montaje siempre sin tensión eléctrica. En caso contrario, se pueden producir peligrosas corrientes a través del cuerpo y, por tanto, lesiones físicas.
- **Asegurar que la señal funcione solo a la tensión admisible** (ver Datos técnicos).

Consejos importantes

- Las instrucciones de empleo forman parte integrante del producto y, por este motivo, deben conservarse y entregarse al nuevo comprador en el caso de venta o transmisión del producto.
- Para las reparaciones, por favor diríjase a su distribuidor Märklin.
- Eliminación: www.maerklin.com/en/imprint.html

Datos técnicos

Carga admisible	≤ 100 mA
Carga de salida de vía	máx. 2 A
Rigidez dieléctrica	máx. 40 V

Funciones

- Apta para multiprotocolo: fx (MM), mfx* y DCC
- Selección del modo de funcionamiento con microint. DIP
- Direcciones configurables con microint. DIP:
 - 1-256** fx (MM) (Control Unit 6021)
 - 1-320** fx (MM) (Central Station 6021x/Mobile Station 60653)
 - 1-511** (DCC)
- Direcciones programables vía CV
 - 1-2.040** DCC
- Modificaciones de las propiedades vía CV
- Alimentación eléctrica vía circuito digital

Montaje de la señal

Antes del montaje propiamente dicho, debe programarse la señal.

* mfx no está disponible hasta la versión de software 4.0 de la CS 2

Está permitido ejecutar las siguientes operaciones únicamente sin tensión eléctrica:

Configuración de la dirección en el modo de funcionamiento mediante el microint. DIP:

- Configuración del modo de funcionamiento con microint. DIP 10
Microinterruptor 10 retirado = fx (MM) / mfx
Microinterruptor 10 colocado = DCC
- fx (MM)/DCC Configuración de la dirección con microint. DIP (Tabla a partir de página 28)

Tenga presente lo siguiente: Realizar la configuración con el microint. DIP siempre sin tensión eléctrica. La señal no identifica las posiciones actuales del microinterruptor hasta que se activa la tensión.

Programación con CS2 / CS 3

fx (MM)

La programación de variables CV debe realizarse en la vía de programación. Está permitido conectar a la vía de programación **siempre solo una señal**.

En el modo fx (MM) pueden modificarse las siguientes CVs: CV 39, 40, 41 y 42. En las CV 41 y 42, en el modo fx (MM), el valor debe dividirse por 4 ya que están permitidos los valores 0-80, p. ej., $255/4 = 64$ (redondeado).

Durante la operación de programación, la lámpara de la señal destella y, a diferencia de ello, durante la operación de programación, la lámpara de la señal destella mientras que, por el contrario, durante la programación con la Central Station la señal se conmuta. Una vez finalizada la programación, se cambia la señal a «Marcha».

Encontrará el procedimiento en la programación con la Control Unit 6021 en www.maerklin.de -> Service -> Technische Informationen.

Para realizar la programación con otras unidades de control, consulte su manual de instrucciones de empleo.

DCC

La programación de las CVs debe realizarse en la vía de programación. Está permitido conectar a la vía de programación **siempre solo una señal**.

Durante la transmisión de datos, a modo de comprobación, luce el farol de la señal.

Para realizar la programación con otras unidades de control, consulte el manual de instrucciones de empleo de la unidad en cuestión.

Programación con la MS 2

Para programar las señales con la Mobile Station 2 se debe crear una locomotora nueva en MM2 o DCC.

En tal caso, asegúrese de que la señal a programar haya sido configurada, mediante los interruptores codificadores, también a MM2 o DCC y a la misma dirección que la locomotora. Esta locomotora nueva creada se necesita solo para la programación de las señales. Para ello, vaya a "Configurar locomotora" en el menú de la MS 2 " y seleccione "Programar CVs".

Durante la programación de las CVs no debe estar conectada ninguna otra locomotora, señal o decoder de desvío.

CV para fx (MM) y DCC

En fx (MM), es posible configurar la dirección solo con el micro-interruptor DIP. Los valores entre paréntesis representan la configuración de fábrica.

CV	Significado	Valores	
1	Dirección 1 - 255	1-255 (1)	solo DCC
9	Direcciones 256 - 2040	0-7 (0)	solo DCC
39	Movimiento lento	0 (0)	
PoM*	Movimiento semirrápido	1	
	Movimiento semirrápido con rebasculación	2	
	Movimiento semirrápido con rebasculación	3	
	Movimiento rápido con rebasculación	4	
	Movimiento semirrápido con rebasculación de brazo 1	5	solo con 70382
	Movimiento semirrápido con rebasculación de brazo 2	6	solo con 70382
40	Alumbrado	0 - 15 (15)	0 Luz apagada Regular intensidad a 0-15, en donde 15 equivale a brillo 100%
PoM*			
41	Posición central brazo 1	0 - 255	Configuración de la posición central para el brazo de todas las señales
PoM*			

CV	Significado	Valores	
42	Posición central brazo 2	0 - 255	solo en 70382 Configuración de la posición central para el segundo brazo
PoM*			



*La programación en marcha PoM, siempre que así lo soporte la unidad de control, puede realizarse en la vía principal.

Configuración y cálculo de las direcciones mayores que 255 (DCC):

P. ej., dirección 1044 -> $1044:256=4,078125$. El valor antes de la coma (4) debe registrarse en la variable CV 9. El valor decimal (0.078125) se multiplica por 256 $0,078125 \times 256=20$. El valor calculado, 20, debe registrarse en la variable CV 1.

Funcionamiento en modo mfx

El inicio de sesión en mfx se puede realizar en modo MM o DCC. El modo de funcionamiento se selecciona con el microinterruptor DIP 10.

El inicio de sesión en modo mfx se inicia con la CS2 60213/60214/60215 en la configuración de artículos magnéticos a través de  >  y con la CS3 60216/60226 en la configuración de artículos magnéticos a través de  > "Buscar artículos mfx".

Nota sobre el inicio de sesión en mfx con la CS2:

Posibilidad de selección de „Asignar automáticamente artículos magnéticos“ en „Setup (configuración)“ >  > „Vía“.

Si en estas funciones se ha activado la marca de verificación, el inicio de sesión en modo mfx se realiza en las primeras direcciones libres de la CS2. Si no está activada la marca de verificación, el inicio de sesión en mfx se realiza en las direcciones realmente programadas en el decoder.

Impiego commisurato alla destinazione

- Tale segnale è da installare in impianti di ferrovia in miniatura H0 digitali.
- Per il funzionamento analogico tale segnale deve venire impiegato solo con il quadro di comando 72760.
- Deve venire utilizzato soltanto in ambienti chiusi.

Corredo di fornitura

- 1 segnale
- 1 cavetto con spina a 2 poli, rosso e marrone
- 2 squadrette di supporto per montaggio sotto plancia
- 1 piastra di supporto per binario C
- 7 tabelle da segnali
- 1 basamento da innesto
- 1 figure trasferibili per identificazione
- Istruzioni di montaggio con mascherina per montaggio sotto plancia
- Certificato di garanzia

Per il montaggio sotto plancia, attrezzi aggiuntivi necessari: cacciavite, 4x viti a testa svasata Ø 2,5mm x (lunghezza dipendente dalla profondità di montaggio), punte da trapano Ø 16mm e 2mm.

Avvertenze di sicurezza

- **ATTENZIONE!** Bordi e spigoli acuminati per necessità funzionali.
- Eseguire i lavori di cablaggio e montaggio soltanto nelle condizioni di assenza di tensione. In caso di mancato rispetto, questo può portare a pericolose correnti corporee e pertanto a ferimenti.
- **Si faccia funzionare il segnale solamente con la tensione ammissibile** (si vedano i dati tecnici).

Avvertenze importanti

- Le istruzioni di impiego costituiscono parte integrante del prodotto e devono pertanto venire conservate con cura nonché consegnate insieme in caso di cessione a terzi del prodotto.
- Per riparazioni Vi preghiamo di rivolgerVi al Vostro rivenditore specialista Märklin.
- Smaltimento: www.maerklin.com/en/imprint.html

Dati tecnici

- Carico ≤ 100 mA
- Carico all'uscita per il binario max. 2 A
- Resistenza alla tensione max. 40 V

Funzioni

- Adatto a protocolli multipli: fx (MM), mfx* e DCC
- Impostazione del tipo di esercizio a mezzo commutatore DIP
- Indirizzi impostabili con commutatore DIP:
 - 1-256** fx (MM) (Control Unit 6021)
 - 1-320** fx (MM) (Central Station 6021x/Mobile Station 60653)
 - 1-511** (DCC)
- Indirizzi programmabili tramite le CV
 - 1-2.040** DCC
- Variazioni delle caratteristiche tramite le CV
- Alimentazione di corrente tramite circuito di corrente digitale
- Illuminazione del segnale disattivabile oppure attivabile

Montaggio del segnale

Prima del vero e proprio montaggio il segnale deve venire programmato.

* mfx solo a partire da CS 2 con Software versione 4.0

I seguenti passi del lavoro devono venire eseguiti soltanto nelle condizioni esenti da tensione:

Impostazione dell'indirizzo e del tipo di funzionamento mediante il commutatore DIP:

- Impostazione del tipo di funzionamento con commutatore DIP 10
Commutatore 10 off = fx (MM) / mfx
Commutatore 10 on = DCC
- fx (MM)/DCC impostazione dell'indirizzo con commutatore DIP (Tabella da pagina 28)

Prestate attenzione: Intraprendere le impostazioni con il commutatore DIP-Schalter sempre senza tensione. Il segnale riconosce le disposizioni attuali del commutatore solo con l'accensione della tensione.

Programmazione con CS 2 / CS 3

fx (MM)

La programmazione delle CV deve avvenire sul binario di programmazione. Al binario di programmazione deve venire collegato **sempre soltanto un segnale**.

Le seguenti CV possono venire modificate nel caso di fx (MM): CV 39, 40, 41 e 42. Nelle CV 41 e 42 in caso di fx (MM) il valore deve venire diviso per 4, poiché sono consentiti valori 0-80, ad es. $255/4 = 64$ (arrotondato).

Durante la procedura di programmazione la luce del segnale lampeggia, in modo differente da ciò durante la programmazione con la Central Station il segnale è acceso. Dopo la conclusione del procedimento di programmazione il segnale viene disposto su „via libera“.

Il procedimento durante la programmazione con la Control Unit

6021 potete trovarlo su www.maerklin.de -> Service -> Technische Informationen.

La programmazione con altri apparati siete pregati di desumerla dalle istruzioni di azionamento del rispettivo apparato di controllo.

DCC

La programmazione delle CV deve avvenire sul binario di programmazione. Al binario di programmazione deve venire collegato **sempre soltanto un segnale**.

Durante il trasferimento dei dati per controllo lampeggia il fanale sul segnale.

La programmazione con altri apparati siete pregati di desumerla dalle istruzioni di azionamento del rispettivo apparato di controllo.

Programmazione con MS 2

Per la programmazione dei segnali con la Mobile Station 2 deve venire definita manualmente una nuova locomotiva sotto MM2 oppure DCC. Si prega di prestare attenzione al fatto che poi anche il segnale da programmare mediante il commutatore di codifica sia stato impostato su MM2 oppure DCC, sullo stesso indirizzo come tale locomotiva. Questa locomotiva definita come nuova è necessaria soltanto per la programmazione del segnale. A tale scopo andate nel Menù della MS 2 su „Configurazione loco“ e successivamente su „Programmazione CV“. Durante tale programmazione delle CV non deve essere collegata alcuna altra locomotiva, segnale oppure Decoder per deviatoi.

CV per fx (MM) e DCC

Sotto fx (MM) l'indirizzo può venire impostato solo con il commutatore DIP. I valore in parentesi sono le impostazioni di fabbrica.

CV	Significato	Valore	
1	Indirizzi 1 - 255	1-255 (1)	solo DCC
9	Indirizzi 256 - 2040	0-7 (0)	solo DCC
39	Movimento lento	0 (0)	
PoM*	Movimento a media velocità	1	
	Movimento rapido	2	
	Movimento a media velocità con rimbalzo	3	
	Movimento rapido con rimbalzo	4	
	Movimento a media velocità con rimbalzo ala 1	5	solo nel caso 70382
	Movimento a media velocità con rimbalzo ala 2	6	solo nel caso 70382
40	Illuminazione	0 - 15 (15)	0 luce spenta attenuazione 0-15, dove 15 = 100% uguale a luminosità
PoM*			
41	Posizione media ala 1	0 - 255	Impostazione della posizione media per le ali di tutti i segnali
PoM*			
42	Posizione media ala 2	0 - 255	solo nel caso 70382 Impostazione della posizione media per la 2ª ala
PoM*			



*La programmazione PoM avviene sul binario principale, purché essa venga supportata all'apparato di comando.

Impostazione e calcolo degli indirizzi maggiori di 255 (DCC):

Ad es. indirizzo 1044 -> 1044:256=4,078125 . Il valore prima della virgola (4) viene inserito in CV 9. Il valore dopo la virgola (0,078125) viene moltiplicato per 256: 0,078125x256=20. Il valore calcolato 20 deve venire inserito nella CV 1.

Esercizio sotto mfx

La registrazione mfx può avvenire sotto MM oppure DCC. È discriminante il tipo di funzionamento impostato tramite il commutatore Dip 10.

La registrazione mfx viene avviata con la CS2 60213/60214/60215 nella configurazione degli apparati elettromagnetici tramite  >  e con la CS3 60216/60226 nella configurazione degli apparati elettromagnetici tramite  > „ricerca apparati mfx“.

Avvertenza sull'iscrizione mfx con la CS2:

Possibilità di selezione „Assegnare automaticamente apparati elettromagnetici“ sotto „Setup“ >  > „Binario“.

Se colà è posto il segno di spunta la registrazione mfx avviene sul primo indirizzo libero nella CS2. Se il segno di spunta non è collocato, la registrazione mfx avviene sull'indirizzo effettivamente programmato sul Decoder.

Användningsområde

- Signal avsedd för inbyggnad i digitala H0-modelljärnvägar.
- Vid analog drift får signalen endast användas tillsammans med ställpult nr 72760.
- Signalen får endast användas i torra utrymmen.

Innehåll

- 1 Signal
- 1 Kabel med 2-polig stickkontakt, röd och brun
- 2 Vinkelhållare för montage under anläggningen
- 1 Fästesplatta för C-räls
- 7 Signaltavla
- 1 Insticksfot
- 1 Dekal för uppmärklning
- Bruksanvisning med schablon för montage på anläggningens undersida
- Garantisedel

För montage på anläggningens undersida behöver man följande verktyg: Skruvmejsel, 4 X skruvar med försänkskalle \varnothing 2,5 mm x (längden beroende på underlagets tjocklek), borrar med \varnothing 16 mm och \varnothing 2 mm.

Säkerhetsföreskrifter

- **WARNING!** Funktionsbetingade vassa kanter och spetsar.
- **OBS!** Risk för farliga elstötar och risk för kroppsskada! Infästning av kablar, elanslutningar och montage får därför endast göras i spänningslöst tillstånd.
- **Signalen får endast matas med tillåten/korrekt spänning!** (Se tekniska data i bruksanvisningen.)

Viktig information

- Bruksanvisningen är en del av denna produkt och måste där- för sparas och den skall medfölja vid överlåtelse av produkten till tredje man.
- För ev. reparation måste man vända sig till sin Märklin-fack-handlare.
- För hantering som avfall v.g. se: www.maerklin.com/en/im-print.html

Tekniska data

- Belastning ≤ 100 mA
- Belastning spårutgång max. 2 A
- Spänning max. 40 V

Funktioner

- Anpassade för multiprotokoll:fx (MM), mfx* och DCC
- Inställning av drifttyp görs med DIP-switchar
- Inställbara adresser med DIP-switchar:
 - 1-256** fx (MM) (ControlUnit 6021)
 - 1-320** fx (MM) (Central Station 6021x/Mobile Station 60653)
 - 1-511** (DCC)
- Programmerbara adresser via CV
 - 1-2.040** DCC
- Ändring av egenskaper via CV
- Strömförsörjning via den digitala strömkretsen

Signal-inbyggnad

Innan signalen byggs in/kopplas in i anläggningen måste den programmeras.

* mfx först fr.o.m. CS 2 softwareversion 4.0

Följande arbetsmoment får endast utföras i spänningslöst tillstånd:

Inställning av adresser och drifttyp med DIP-switchar:

- Inställning av drifttyp med DIP-switch 10
Switch 10 off = fx (MM) / mfx
Switch 10 on = DCC
- fx (MM)/DCC inställning av adresser med DIP-switchar (tabeller på sidan 28)

Observera: Inställningar med DIP-switchar får endast göras i spänningslöst tillstånd! Signalen visar den aktuella inställningen först efter att elspänningen anslutits.

Programmering med CS 2 / CS 3

fx (MM)

CV-programmering måste göras via programmeringsspåret.

OBS! Endast en enda signal i taget får anslutas till programmeringsspåret.

Följande CV kan ändras med fx (MM): CV 39, 40, 41 och 42. Betr. CV 41 och 42 måste med fx (MM) värdet delas med 4, eftersom värdena 0 - 80 finns tillgängliga, t.ex. $255/4 = 64$ (avrundat).

Under pågående programmering blinkar signalens lyktor, ev. avvikelser under programmeringen kan ändras med Central Station. Efter avslutad programmering är signalen ställd på "kör".

Hur programmering genomförs med hjälp av Control Unit 6021 återfinns på www.maerklin.de -> Service -> Technische Informationen.

Vid programmering med andra körkontroller: V.g. se bruksanvisningen till respektive körkontroll.

DCC

CV-programmering måste göras via programmeringsspåret.

OBS! Endast en enda signal i taget får anslutas till programmeringsspåret.

Under pågående dataöverföring blinkar som bekräftelse signalens lyktor.

Vid programmering med andra körkontroller: V.g. se bruksanvisningen till respektive körkontroll.

Programmering med MS 2

För att programmera signalerna med Mobile Station 2 måste ett nytt lokomotiv skrivas in under MM2 eller DCC.

Observera då att signalen som ska programmeras ska via decodern kodas för MM2 eller DCC, samt på samma adress som loket ställts in på. Det nyinskrivna loket används bara för programmering av signalen. Gå därför in på MS 2-menyn, "konfiguration av lok" och därefter på "CV-programmering".

Under CV-programmeringen får inga andra lok, signaler eller växeldekodrar vara anslutna eller aktiverade.

CV för fx (MM) och DCC

under fx (MM) kan adresserna endast ställas in med DIP-switcharna. Angivna värden inom klammer är fabriksinställningar.

CV	Innebörd	Värde	
1	Adresser 1 - 255	1-255 (1)	endast DCC
9	Adresser 256 - 2040	0-7 (0)	endast DCC

CV	Innebörd	Värde	
39	Långsam rörelse	0 (0)	
PoM*	Medelsnabb rörelse	1	
	Snabb rörelse	2	
	Medelsnabb rörelse med omställning	3	
	Snabb rörelse med omställning	4	
	Medelsnabb rörelse med omställning vinge 1	5	endast för 70382
	Medelsnabb rörelse med omställning vinge 2	6	endast för 70382
40	Belysning	0 - 15 (15)	0 ljuset släckt dimmer 0-15, varvid 15 = 100% ljusstyrka
PoM*			
41	Mellanläge vinge 1	0 - 255	Inställning av mellanläge för samtliga signalers vingar
PoM*			
42	Mellanläge vinge 2	0 - 255	endast för 70382 inställning av mellanläge för vinge 2
PoM*			

*PoM programmering kan, om körkontrollen tillåter detta, göras via anläggningens huvudspår.

Inställning och beräkning av adresser större än 255 (DCC):

T.ex. Adress 1044 -> $1044:256=4,078125$. Värdet efter kommatecknet (0,078125) multipliceras med 256 $0,078125 \times 256=20$. Det framräknade värdet måste tas in i CV 1.

Körning med mfx

Mfx-inställning kan göras med både MM och DCC.

Drifttyp ställs in med hjälp av dip-switch nr 10.

Mfx-inställningen görs med CS2 60213/60214/60215 i magnetartikelkonfigurationen via  > 

och med CS3 60216/60226 i magnetartikelkonfigurationen via  > "sökning av mfx-artiklar".

Information om mfx-inställning med CS2:

Valmöjlighet: "Automatisk tilldelning av magnetartikel" under "Setup" >  > "spår".

Om man markerar detta val så genomförs mfx-inställningen på den första lediga adressen i CS2. Om man inte markerar detta så genomförs mfx-inställningen på den adress som dekodern redan är inställd på.

Hensigtsmæssig anvendelse

- Signalet er til indbygning i H0 digital-modelbaneanlæg.
- Signalet må til analogdrift kun anvendes med kontrolpanel 72760.
- Må kun anvendes i lukkede rum.

Leveringsomfang

- 1 signal
- 1 kabel med stik, 2-polet, rød og brun
- 2 holdebeslag til underhængt montering
- 1 holdeplads C-skinne
- 7 signaltavler
- 1 stikfod
- 1 overføringsbillede til mærkning
- Indbygningsvejledning med skabelon til underhængt montering
- Garantibevis

Værktøj, der skal bruges til underhængt montering: Skruetrækker, 4x nedsænkningsskruer Ø 2,5 mm x (længden afhænger af indbygningsdybden), bor Ø 16 mm og 2mm.

Sikkerhedsvejledning

- **BEMÆRK!** Funktionsbetingede skarpe kanter og spidser.
- Kabel- og monteringsopgaver må udelukkende foretages i spændingsfri tilstand. Manglende overholdelse kan føre til farlig strøm gennem kroppen og skader.
- **Signalet må kun drives med den tilladte spænding** (se tekniske data).

Vigtig information

- Betjeningsvejledningen er del af produktet og skal derfor opbevares sammen med produktet og gives videre til tredje-mand sammen med produktet.
- Kontakt din Märklin-forhandler for reparationer.
- Bortskaffelse: www.maerklin.com/en/imprint.html

Tekniske data

- Belastning ≤ 100 mA
- Belastning skinneudgang maks. 2 A
- Holdespænding maks. 40 V

Funktioner

- Mulig multiprotokol: fx (MM), mfx* og DCC
- Indstilling af driftsform ved hjælp af DIP-kontakt
- Indstilling af adresser ved hjælp af DIP-kontakt:
1-256 fx (MM) (Control Unit 6021)
1-320 fx (MM) (Central Station 6021x/Mobile Station 60653)
1-511 (DCC)
- Programmérbare adresser via CV
1-2.040 DCC
- Ændring af egenskaber via CV
- Strømforsyning via digitalstrømkreds

Signalindbygning

Signalet skal programmeres inden indbygning.

* mfx først fra CS 2 Softwareversion 4.0

Følgende arbejdsstrin må kun udføres i spændingsfri tilstand:

Indstilling af adresser og driftsform via DIP-kontakten:

- Indstilling af driftsform ved hjælp af DIP-kontakt 10
Kontakt 10 off = fx (MM) / mfx
Kontakt 10 on = DCC
- fx (MM)/DCC indstilling af adresser med DIP-kontakt (tabel fra side 28)

Bemærk: Indstillinger med DIP-kontakten skal altid foretages i spændingsfri tilstand. Signalet genkender først den aktuelle kontaktindstilling, når spændingen aktiveres.

Programmering med CS 2 / CS 3

fx (MM)

CV-programmeringen skal foretages på programmeringsskinen. Der må altid **kun tilsluttes et signal** på programmeringsskinen.

Følgende CV'er kan ændres ved fx (MM): CV 39, 40, 41 og 42. Ved CV 41 og 42, skal ved fx (MM) værdien deles med 4, for kun værdierne 0-80 er tilladte, f. eks. 255/4 = 64 (afrundet).

Signallampen blinker under programmeringen; uafhængigt deraf aktiveres signalet med Central Station under programmeringen. Efter afsluttet programmering, indstilles signalet på „Kørsel“.

Fremgangsmåden til programmering med Control Unit 6021 findes på www.maerklin.de -> Service -> Technische Informationen.

Beskrivelse af programmeringen med andre enheder findes i betjeningsvejledningen for den pågældende styreenhed.

DCC

CV-programmeringen skal foretages på programmeringsskinen. Der må altid **kun tilsluttes et signal** på programmeringsskinen. Signalets lampe blinker til kontrol under hele dataoverførslen. Beskrivelse af programmeringen med andre enheder findes i betjeningsvejledningen for den pågældende styreenhed.

Programmering med MS 2

Til programmering af signalerne med Mobile Station 2 skal der oprettes et nyt lokomotiv manuelt under MM2 eller DCC. Bemærk venligst, at det programmerede signal over koderingskontakten så også bliver indstillet på MM2 eller DCC samt den samme adresse som lokomotivet. Det nyoprettede lokomotiv skal kun bruges til programmering af signalerne. Åbn dertil menuen på MS 2 og gå til "Konfiguration af lokomotiv" og derefter "Programmering af CV".

Der må ikke være tilsluttet andre lokomotiver, signaler eller sporskiftedekodere under CV-programmeringen.

CV til fx (MM) og DCC

Under fx (MM) kan adressen kun indstilles med DIP-kontakten. Værdier i parentes er fabriksindstillingerne.

CV	Betydning	Værdier	
1	Adresse 1 - 255	1-255 (1)	kun DCC
9	Adresser 256 - 2040	0-7 (0)	kun DCC

CV	Betydning	Værdier	
39 PoM*	Langsom bevægelse	0 (0)	
	Mellemhurtig bevægelse	1	
	Hurtig bevægelse	2	
	Mellemhurtig bevægelse med eftervip	3	
	Hurtig bevægelse med eftervip	4	
	Mellemhurtig bevægelse med eftervip Vinge 1	5	kun for 70382
	Mellemhurtig bevægelse med eftervip Vinge 2	6	kun for 70382
40 PoM*	Belysning	0 - 15 (15)	0 lys fra dimmer 0-15, hvor 15 = svarer til 100 % lysshed
41 PoM*	Mellemstilling Vinge 1	0 - 255	Indstilling af mellemposition af alle signalers vinger
42 PoM*	Mellemstilling Vinge 2	0 - 255	kun for 70382 Indstilling af mellemposition for 2. vinge

*PoM kan programmeres på hovedskinnen, hvis det understøttes af styreenheden.

Indstilling og beregning af adresser større end 255 (DCC):

F. eks. adresse 1044 -> $1044:256=4,078125$. Værdien før komma (4) skal indtastes i CV 9. Værdien efter komma (0,078125) ganges med 256 ($0,078125 \times 256=20$). Den beregnede værdi 20 indtastes i CV 1.

Drift med mfx

mfx-registreringen kan ske med MM eller DCC.

Den ved hjælp af dip-omskifter indstillede driftsmodus er afgørende.

mfx-registreringen indledes med CS2 60213/60214/60215 i magnetartikelkonfigurationen via  >  og med CS3 60216/60226 i magnetartikelkonfigurationen via  > „søg mfx-artikel“.

Vigtigt vedrørende mfx-registreringen med CS2:

Valgmulighed „tildel magnetartikel automatisk“ under „Setup“ >  > „Spor“.

Er fluebenet sat ved dette punkt, sker mfx-registreringen på de første frie adresser i CS2. Er fluebenet ikke sat ved dette punkt, sker mfx-registreringen på de effektivt ved dekoderen programmerede adresser.

Betriebsart und Adressen einstellen

Setting the mode of operation and addresses

Définir le mode d'exploitation et les adresses

Bedrijfsmodus en adres instellen

Configuración de modo de funcionamiento y direcciones



Impostate tipo di funzionamento e indirizzi



Ställ in driftstyp och adress

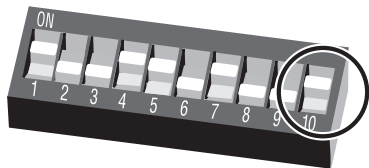

Indstil driftsart og adresser



on = DCC
off = fx (MM)





										10 (0/1)
1	1	1	1						fx (MM)/DCC	
2	1	2	2						fx (MM)/DCC	
3	1	3	1 2						fx (MM)/DCC	
4	1	4		3					fx (MM)/DCC	
5	1	5	1 3						fx (MM)/DCC	
6	1	6		2 3					fx (MM)/DCC	
7	1	7	1 2 3						fx (MM)/DCC	
8	1	8			4				fx (MM)/DCC	
9	1	9	1		4				fx (MM)/DCC	
10	1	10		2 4					fx (MM)/DCC	
11	1	11	1 2	4					fx (MM)/DCC	
12	1	12		3 4					fx (MM)/DCC	
13	1	13	1	3 4					fx (MM)/DCC	
14	1	14		2 3 4					fx (MM)/DCC	
15	1	15	1 2 3 4						fx (MM)/DCC	
16	1	16			5				fx (MM)/DCC	
17	2	1	1		5				fx (MM)/DCC	
18	2	2		2	5				fx (MM)/DCC	
19	2	3	1 2		5				fx (MM)/DCC	
20	2	4		3	5				fx (MM)/DCC	
21	2	5	1	3	5				fx (MM)/DCC	
22	2	6		2 3	5				fx (MM)/DCC	
23	2	7	1 2 3		5				fx (MM)/DCC	
24	2	8			4 5				fx (MM)/DCC	
25	2	9	1		4 5				fx (MM)/DCC	
26	2	10		2	4 5				fx (MM)/DCC	

				10 (0/1)				
27		2 11	1 2	4 5			fx (MM)/DCC	
28		2 12		3 4 5			fx (MM)/DCC	
29		2 13	1	3 4 5			fx (MM)/DCC	
30		2 14		2 3 4 5			fx (MM)/DCC	
31		2 15	1 2 3 4 5				fx (MM)/DCC	
32		2 16			6		fx (MM)/DCC	
33		3 1	1		6		fx (MM)/DCC	
34		3 2		2	6		fx (MM)/DCC	
35		3 3	1 2		6		fx (MM)/DCC	
36		3 4		3	6		fx (MM)/DCC	
37		3 5	1	3	6		fx (MM)/DCC	
38		3 6		2 3	6		fx (MM)/DCC	
39		3 7	1 2 3		6		fx (MM)/DCC	
40		3 8		4	6		fx (MM)/DCC	
41		3 9	1		4 6		fx (MM)/DCC	
42		3 10		2	4 6		fx (MM)/DCC	
43		3 11	1 2		4 6		fx (MM)/DCC	
44		3 12		3 4	6		fx (MM)/DCC	
45		3 13	1	3 4	6		fx (MM)/DCC	
46		3 14		2 3 4	6		fx (MM)/DCC	
47		3 15	1 2 3 4		6		fx (MM)/DCC	
48		3 16			5 6		fx (MM)/DCC	
49		4 1	1		5 6		fx (MM)/DCC	
50		4 2		2	5 6		fx (MM)/DCC	
51		4 3	1 2		5 6		fx (MM)/DCC	



				10 (0/1)				
52		4 4		3	5 6		fx (MM)/DCC	
53		4 5	1	3	5 6		fx (MM)/DCC	
54		4 6		2 3	5 6		fx (MM)/DCC	
55		4 7	1 2 3		5 6		fx (MM)/DCC	
56		4 8			4 5 6		fx (MM)/DCC	
57		4 9	1		4 5 6		fx (MM)/DCC	
58		4 10		2	4 5 6		fx (MM)/DCC	
59		4 11	1 2		4 5 6		fx (MM)/DCC	
60		4 12		3	4 5 6		fx (MM)/DCC	
61		4 13	1	3	4 5 6		fx (MM)/DCC	
62		4 14		2 3	4 5 6		fx (MM)/DCC	
63		4 15	1 2 3		4 5 6		fx (MM)/DCC	
64		4 16				7	fx (MM)/DCC	
65		5 1	1			7	fx (MM)/DCC	
66		5 2		2		7	fx (MM)/DCC	
67		5 3	1 2			7	fx (MM)/DCC	
68		5 4		3		7	fx (MM)/DCC	
69		5 5	1	3		7	fx (MM)/DCC	
70		5 6		2 3		7	fx (MM)/DCC	
71		5 7	1 2 3			7	fx (MM)/DCC	
72		5 8			4	7	fx (MM)/DCC	
73		5 9	1		4	7	fx (MM)/DCC	
74		5 10		2	4	7	fx (MM)/DCC	
75		5 11	1 2		4	7	fx (MM)/DCC	
76		5 12		3 4		7	fx (MM)/DCC	



			10 (0/1)						
77	5 13	1	3 4	7	fx (MM)/DCC				
78	5 14	2 3 4	7	fx (MM)/DCC					
79	5 15	1 2 3 4	7	fx (MM)/DCC					
80	5 16	5 7	fx (MM)/DCC						
81	6 1 1	5 7	fx (MM)/DCC						
82	6 2	2 5 7	fx (MM)/DCC						
83	6 3	1 2 5 7	fx (MM)/DCC						
84	6 4	3 5 7	fx (MM)/DCC						
85	6 5	1 3 5 7	fx (MM)/DCC						
86	6 6	2 3 5 7	fx (MM)/DCC						
87	6 7	1 2 3 5 7	fx (MM)/DCC						
88	6 8	4 5 7	fx (MM)/DCC						
89	6 9	1 4 5 7	fx (MM)/DCC						
90	6 10	2 4 5 7	fx (MM)/DCC						
91	6 11	1 2 4 5 7	fx (MM)/DCC						
92	6 12	3 4 5 7	fx (MM)/DCC						
93	6 13	1 3 4 5 7	fx (MM)/DCC						
94	6 14	2 3 4 5 7	fx (MM)/DCC						
95	6 15	1 2 3 4 5 7	fx (MM)/DCC						
96	6 16	6 7	fx (MM)/DCC						
97	7 1	1 6 7	fx (MM)/DCC						
98	7 2	2 6 7	fx (MM)/DCC						
99	7 3	1 2 6 7	fx (MM)/DCC						
100	7 4	3 6 7	fx (MM)/DCC						
101	7 5	1 3 6 7	fx (MM)/DCC						

			10 (0/1)						
102	7 6	2 3 6 7	fx (MM)/DCC						
103	7 7	1 2 3 6 7	fx (MM)/DCC						
104	7 8	4 6 7	fx (MM)/DCC						
105	7 9	1 4 6 7	fx (MM)/DCC						
106	7 10	2 4 6 7	fx (MM)/DCC						
107	7 11	1 2 4 6 7	fx (MM)/DCC						
108	7 12	3 4 6 7	fx (MM)/DCC						
109	7 13	1 3 4 6 7	fx (MM)/DCC						
110	7 14	2 3 4 6 7	fx (MM)/DCC						
111	7 15	1 2 3 4 6 7	fx (MM)/DCC						
112	7 16	5 6 7	fx (MM)/DCC						
113	8 1	1 5 6 7	fx (MM)/DCC						
114	8 2	2 5 6 7	fx (MM)/DCC						
115	8 3	1 2 5 6 7	fx (MM)/DCC						
116	8 4	3 5 6 7	fx (MM)/DCC						
117	8 5	1 3 5 6 7	fx (MM)/DCC						
118	8 6	2 3 5 6 7	fx (MM)/DCC						
119	8 7	1 2 3 5 6 7	fx (MM)/DCC						
120	8 8	4 5 6 7	fx (MM)/DCC						
121	8 9	1 4 5 6 7	fx (MM)/DCC						
122	8 10	2 4 5 6 7	fx (MM)/DCC						
123	8 11	1 2 4 5 6 7	fx (MM)/DCC						
124	8 12	3 4 5 6 7	fx (MM)/DCC						
125	8 13	1 3 4 5 6 7	fx (MM)/DCC						
126	8 14	2 3 4 5 6 7	fx (MM)/DCC						
127	8 15	1 2 3 4 5 6 7	fx (MM)/DCC						

Key	keyboard										10 (0/1)									
	0	1	2	3	4	5	6	7	8	9	0	1	2	3	4	5	6	7	8	9
128	8	16								8										fx (MM)/DCC
129	9	1	1							8										fx (MM)/DCC
130	9	2		2						8										fx (MM)/DCC
131	9	3	1	2						8										fx (MM)/DCC
132	9	4			3					8										fx (MM)/DCC
133	9	5	1	3						8										fx (MM)/DCC
134	9	6		2	3					8										fx (MM)/DCC
135	9	7	1	2	3					8										fx (MM)/DCC
136	9	8			4					8										fx (MM)/DCC
137	9	9	1		4					8										fx (MM)/DCC
138	9	10		2	4					8										fx (MM)/DCC
139	9	11	1	2	4					8										fx (MM)/DCC
140	9	12			3	4				8										fx (MM)/DCC
141	9	13	1		3	4				8										fx (MM)/DCC
142	9	14		2	3	4				8										fx (MM)/DCC
143	9	15	1	2	3	4				8										fx (MM)/DCC
144	9	16				5				8										fx (MM)/DCC
145	10	1	1			5				8										fx (MM)/DCC
146	10	2		2		5				8										fx (MM)/DCC
147	10	3	1	2		5				8										fx (MM)/DCC
148	10	4			3	5				8										fx (MM)/DCC
149	10	5	1		3	5				8										fx (MM)/DCC
150	10	6		2	3	5				8										fx (MM)/DCC
151	10	7	1	2	3	5				8										fx (MM)/DCC
152	10	8				4	5			8										fx (MM)/DCC
153	10	9	1			4	5			8										fx (MM)/DCC



Key	keyboard										10 (0/1)									
	0	1	2	3	4	5	6	7	8	9	0	1	2	3	4	5	6	7	8	9
154	10	10			2	4	5			8										fx (MM)/DCC
155	10	11	1	2		4	5			8										fx (MM)/DCC
156	10	12			3	4	5			8										fx (MM)/DCC
157	10	13	1		3	4	5			8										fx (MM)/DCC
158	10	14		2	3	4	5			8										fx (MM)/DCC
159	10	15	1	2	3	4	5			8										fx (MM)/DCC
160	10	16					6			8										fx (MM)/DCC
161	11	1	1				6			8										fx (MM)/DCC
162	11	2		2			6			8										fx (MM)/DCC
163	11	3	1	2			6			8										fx (MM)/DCC
164	11	4			3		6			8										fx (MM)/DCC
165	11	5	1		3		6			8										fx (MM)/DCC
166	11	6		2	3		6			8										fx (MM)/DCC
167	11	7	1	2	3		6			8										fx (MM)/DCC
168	11	8				4	6			8										fx (MM)/DCC
169	11	9	1			4	6			8										fx (MM)/DCC
170	11	10		2		4	6			8										fx (MM)/DCC
171	11	11	1	2		4	6			8										fx (MM)/DCC
172	11	12			3	4	6			8										fx (MM)/DCC
173	11	13	1		3	4	6			8										fx (MM)/DCC
174	11	14		2	3	4	6			8										fx (MM)/DCC
175	11	15	1	2	3	4	6			8										fx (MM)/DCC
176	11	16					5	6		8										fx (MM)/DCC
177	12	1	1				5	6		8										fx (MM)/DCC
178	12	2		2			5	6		8										fx (MM)/DCC
179	12	3	1	2			5	6		8										fx (MM)/DCC



										10 (0/1)
			1	2	3	4	5	6	7	
180				3	5	6		8	fx (MM)/DCC	
181			1	3	5	6		8	fx (MM)/DCC	
182			2	3	5	6		8	fx (MM)/DCC	
183			1	2	3	5	6	8	fx (MM)/DCC	
184				4	5	6		8	fx (MM)/DCC	
185			1		4	5	6	8	fx (MM)/DCC	
186			2		4	5	6	8	fx (MM)/DCC	
187			1	2		4	5	6	8	fx (MM)/DCC
188				3	4	5	6	8	fx (MM)/DCC	
189			1		3	4	5	6	8	fx (MM)/DCC
190			2	3	4	5	6	8	fx (MM)/DCC	
191			1	2	3	4	5	6	8	fx (MM)/DCC
192								7	8	fx (MM)/DCC
193			1					7	8	fx (MM)/DCC
194			2					7	8	fx (MM)/DCC
195			1	2				7	8	fx (MM)/DCC
196				3				7	8	fx (MM)/DCC
197			1	3				7	8	fx (MM)/DCC
198			2	3				7	8	fx (MM)/DCC
199			1	2	3			7	8	fx (MM)/DCC
200				4				7	8	fx (MM)/DCC
201			1		4			7	8	fx (MM)/DCC
202			2		4			7	8	fx (MM)/DCC
203			1	2		4		7	8	fx (MM)/DCC
204				3	4			7	8	fx (MM)/DCC
205			1	3	4			7	8	fx (MM)/DCC



										10 (0/1)
			1	2	3	4	5	6	7	
206				2	3	4		7	8	fx (MM)/DCC
207			1	2	3	4		7	8	fx (MM)/DCC
208						5		7	8	fx (MM)/DCC
209			1			5		7	8	fx (MM)/DCC
210			2			5		7	8	fx (MM)/DCC
211			1	2		5		7	8	fx (MM)/DCC
212					3	5		7	8	fx (MM)/DCC
213			1		3	5		7	8	fx (MM)/DCC
214				2	3	5		7	8	fx (MM)/DCC
215			1	2	3	5		7	8	fx (MM)/DCC
216					4	5		7	8	fx (MM)/DCC
217			1		4	5		7	8	fx (MM)/DCC
218			2		4	5		7	8	fx (MM)/DCC
219			1	2		4	5	7	8	fx (MM)/DCC
220				3	4	5		7	8	fx (MM)/DCC
221			1	3	4	5		7	8	fx (MM)/DCC
222			2	3	4	5		7	8	fx (MM)/DCC
223			1	2	3	4	5	7	8	fx (MM)/DCC
224							6	7	8	fx (MM)/DCC
225			1				6	7	8	fx (MM)/DCC
226			2				6	7	8	fx (MM)/DCC
227			1	2			6	7	8	fx (MM)/DCC
228					3		6	7	8	fx (MM)/DCC
229			1		3		6	7	8	fx (MM)/DCC
230			2	3			6	7	8	fx (MM)/DCC
231			1	2	3		6	7	8	fx (MM)/DCC



Key	Keyboard		ON							10 (0/1)	
	1	2	3	4	5	6	7	8	9	0	
232	15	8			4	6	7	8		fx (MM)/DCC	
233	15	9	1		4	6	7	8		fx (MM)/DCC	
234	15	10		2	4	6	7	8		fx (MM)/DCC	
235	15	11	1	2	4	6	7	8		fx (MM)/DCC	
236	15	12			3	4	6	7	8	fx (MM)/DCC	
237	15	13	1		3	4	6	7	8	fx (MM)/DCC	
238	15	14		2	3	4	6	7	8	fx (MM)/DCC	
239	15	15	1	2	3	4		6	7	8	fx (MM)/DCC
240	15	16				5	6	7	8	fx (MM)/DCC	
241	16	1	1			5	6	7	8	fx (MM)/DCC	
242	16	2		2		5	6	7	8	fx (MM)/DCC	
243	16	3	1	2		5	6	7	8	fx (MM)/DCC	
244	16	4			3	5	6	7	8	fx (MM)/DCC	
245	16	5	1		3	5	6	7	8	fx (MM)/DCC	
246	16	6		2	3	5	6	7	8	fx (MM)/DCC	
247	16	7	1	2	3	5	6	7	8	fx (MM)/DCC	
248	16	8			4	5	6	7	8	fx (MM)/DCC	
249	16	9	1		4	5	6	7	8	fx (MM)/DCC	
250	16	10		2	4	5	6	7	8	fx (MM)/DCC	
251	16	11	1	2		4	5	6	7	8	fx (MM)/DCC
252	16	12			3	4	5	6	7	8	fx (MM)/DCC
253	16	13	1		3	4	5	6	7	8	fx (MM)/DCC
254	16	14		2	3	4	5	6	7	8	fx (MM)/DCC
255	16	15	1	2	3	4	5	6	7	8	fx (MM)/DCC
256	16	16							9	fx (MM)/DCC	
257	17	1	1						9	fx (MM)/DCC	



Key	Keyboard		ON							10 (0/1)	
	1	2	3	4	5	6	7	8	9	0	
258	17	2								9	fx (MM)/DCC
259	17	3	1	2						9	fx (MM)/DCC
260	17	4				3				9	fx (MM)/DCC
261	17	5	1			3				9	fx (MM)/DCC
262	17	6		2	3					9	fx (MM)/DCC
263	17	7	1	2	3					9	fx (MM)/DCC
264	17	8					4			9	fx (MM)/DCC
265	17	9	1				4			9	fx (MM)/DCC
266	17	10		2			4			9	fx (MM)/DCC
267	17	11	1	2			4			9	fx (MM)/DCC
268	17	12				3	4			9	fx (MM)/DCC
269	17	13	1			3	4			9	fx (MM)/DCC
270	17	14		2	3	4				9	fx (MM)/DCC
271	17	15	1	2	3	4				9	fx (MM)/DCC
272	17	16						5		9	fx (MM)/DCC
273	18	1	1					5		9	fx (MM)/DCC
274	18	2		2				5		9	fx (MM)/DCC
275	18	3	1	2				5		9	fx (MM)/DCC
276	18	4				3		5		9	fx (MM)/DCC
277	18	5	1			3		5		9	fx (MM)/DCC
278	18	6		2	3			5		9	fx (MM)/DCC
279	18	7	1	2	3			5		9	fx (MM)/DCC
280	18	8					4	5		9	fx (MM)/DCC
281	18	9	1				4	5		9	fx (MM)/DCC
282	18	10		2			4	5		9	fx (MM)/DCC
283	18	11	1	2			4	5		9	fx (MM)/DCC



													
		10 (0/1)											
284	18	12			3	4	5				9	fx (MM)/DCC	
285	18	13	1		3	4	5				9	fx (MM)/DCC	
286	18	14		2	3	4	5				9	fx (MM)/DCC	
287	18	15	1	2	3	4	5				9	fx (MM)/DCC	
288	18	16						6			9	fx (MM)/DCC	
289	19	1	1					6			9	fx (MM)/DCC	
290	19	2		2				6			9	fx (MM)/DCC	
291	19	3	1	2				6			9	fx (MM)/DCC	
292	19	4			3			6			9	fx (MM)/DCC	
293	19	5	1		3			6			9	fx (MM)/DCC	
294	19	6		2	3			6			9	fx (MM)/DCC	
295	19	7	1	2	3			6			9	fx (MM)/DCC	
296	19	8				4		6			9	fx (MM)/DCC	
297	19	9	1			4		6			9	fx (MM)/DCC	
298	19	10		2		4		6			9	fx (MM)/DCC	
299	19	11	1	2		4		6			9	fx (MM)/DCC	
300	19	12			3	4		6			9	fx (MM)/DCC	
301	19	13	1		3	4		6			9	fx (MM)/DCC	
302	19	14		2	3	4		6			9	fx (MM)/DCC	
303	19	15	1	2	3	4		6			9	fx (MM)/DCC	
304	19	16					5	6			9	fx (MM)/DCC	
305	20	1	1				5	6			9	fx (MM)/DCC	
306	20	2		2			5	6			9	fx (MM)/DCC	
307	20	3	1	2			5	6			9	fx (MM)/DCC	
308	20	4			3		5	6			9	fx (MM)/DCC	
309	20	5	1		3		5	6			9	fx (MM)/DCC	



														
		10 (0/1)												
310	20	6			2	3			5	6		9	fx (MM)/DCC	
311	20	7	1	2	3				5	6		9	fx (MM)/DCC	
312	20	8							4	5	6		9	fx (MM)/DCC
313	20	9	1						4	5	6		9	fx (MM)/DCC
314	20	10		2					4	5	6		9	fx (MM)/DCC
315	20	11	1	2					4	5	6		9	fx (MM)/DCC
316	20	12				3	4	5	6				9	fx (MM)/DCC
317	20	13	1			3	4	5	6				9	fx (MM)/DCC
318	20	14		2	3	4	5	6					9	fx (MM)/DCC
319	20	15	1	2	3	4	5	6					9	fx (MM)/DCC
320	20	16								7			9	fx (MM)/DCC
321	21	1	1							7	9			---/DCC
322	21	2		2						7	9			---/DCC
323	21	3	1	2						7	9			---/DCC
324	21	4				3				7	9			---/DCC
325	21	5	1			3				7	9			---/DCC
326	21	6		2	3					7	9			---/DCC
327	21	7	1	2	3					7	9			---/DCC
328	21	8							4		7	9		---/DCC
329	21	9	1						4		7	9		---/DCC
330	21	10		2					4		7	9		---/DCC
331	21	11	1	2					4		7	9		---/DCC
332	21	12				3	4			7	9			---/DCC
333	21	13	1			3	4			7	9			---/DCC
334	21	14		2	3	4				7	9			---/DCC
335	21	15	1	2	3	4				7	9			---/DCC



	 keyboard	 1 2 3 4 5 6 7 8 9 0										10 (0/1)			
		336	21 16					5	7	9	---	/	DCC		
337	22 1	1				5	7	9	---	/	DCC				
338	22 2		2			5	7	9	---	/	DCC				
339	22 3	1 2				5	7	9	---	/	DCC				
340	22 4			3		5	7	9	---	/	DCC				
341	22 5	1		3		5	7	9	---	/	DCC				
342	22 6		2 3			5	7	9	---	/	DCC				
343	22 7	1 2 3				5	7	9	---	/	DCC				
344	22 8				4 5	7	9	---	/	DCC					
345	22 9	1			4 5	7	9	---	/	DCC					
346	22 10		2		4 5	7	9	---	/	DCC					
347	22 11	1 2			4 5	7	9	---	/	DCC					
348	22 12			3 4 5	7	9	---	/	DCC						
349	22 13	1		3 4 5	7	9	---	/	DCC						
350	22 14		2 3 4 5	7	9	---	/	DCC							
351	22 15	1 2 3 4 5	7	9	---	/	DCC								
352	22 16				6 7	9	---	/	DCC						
353	23 1	1			6 7	9	---	/	DCC						
354	23 2		2		6 7	9	---	/	DCC						
355	23 3	1 2			6 7	9	---	/	DCC						
356	23 4			3		6 7	9	---	/	DCC					
357	23 5	1		3		6 7	9	---	/	DCC					
358	23 6		2 3			6 7	9	---	/	DCC					
359	23 7	1 2 3				6 7	9	---	/	DCC					
360	23 8				4	6 7	9	---	/	DCC					
361	23 9	1			4	6 7	9	---	/	DCC					



	 keyboard	 1 2 3 4 5 6 7 8 9 0										10 (0/1)			
		362	23 10						2	4	6	7	9	---	/
363	23 11	1 2					4	6	7	9	---	/	DCC		
364	23 12					3 4	6	7	9	---	/	DCC			
365	23 13	1				3 4	6	7	9	---	/	DCC			
366	23 14		2 3 4	6	7	9	---	/	DCC						
367	23 15	1 2 3 4	6	7	9	---	/	DCC							
368	23 16						5 6 7	9	---	/	DCC				
369	24 1	1					5 6 7	9	---	/	DCC				
370	24 2		2				5 6 7	9	---	/	DCC				
371	24 3	1 2					5 6 7	9	---	/	DCC				
372	24 4				3		5 6 7	9	---	/	DCC				
373	24 5	1			3		5 6 7	9	---	/	DCC				
374	24 6		2 3				5 6 7	9	---	/	DCC				
375	24 7	1 2 3					5 6 7	9	---	/	DCC				
376	24 8						4 5 6 7	9	---	/	DCC				
377	24 9	1					4 5 6 7	9	---	/	DCC				
378	24 10		2				4 5 6 7	9	---	/	DCC				
379	24 11	1 2					4 5 6 7	9	---	/	DCC				
380	24 12					3 4 5 6 7	9	---	/	DCC					
381	24 13	1				3 4 5 6 7	9	---	/	DCC					
382	24 14		2 3 4 5 6 7	9	---	/	DCC								
383	24 15	1 2 3 4 5 6 7	9	---	/	DCC									
384	24 16							8 9	---	/	DCC				
385	25 1	1						8 9	---	/	DCC				
386	25 2		2					8 9	---	/	DCC				
387	25 3	1 2						8 9	---	/	DCC				

										10 (0/1)	
388	25 4			3					8 9	---/DCC	
389	25 5	1		3					8 9	---/DCC	
390	25 6		2 3						8 9	---/DCC	
391	25 7	1 2 3							8 9	---/DCC	
392	25 8			4					8 9	---/DCC	
393	25 9	1		4					8 9	---/DCC	
394	25 10		2	4					8 9	---/DCC	
395	25 11	1 2		4					8 9	---/DCC	
396	25 12			3 4					8 9	---/DCC	
397	25 13	1		3 4					8 9	---/DCC	
398	25 14		2 3 4						8 9	---/DCC	
399	25 15	1 2 3 4							8 9	---/DCC	
400	25 16					5			8 9	---/DCC	
401	26 1	1				5			8 9	---/DCC	
402	26 2		2			5			8 9	---/DCC	
403	26 3	1 2				5			8 9	---/DCC	
404	26 4			3		5			8 9	---/DCC	
405	26 5	1		3		5			8 9	---/DCC	
406	26 6		2 3	5					8 9	---/DCC	
407	26 7	1 2 3		5					8 9	---/DCC	
408	26 8			4 5					8 9	---/DCC	
409	26 9	1		4 5					8 9	---/DCC	
410	26 10		2	4 5					8 9	---/DCC	
411	26 11	1 2		4 5					8 9	---/DCC	
412	26 12			3 4 5					8 9	---/DCC	
413	26 13	1		3 4 5					8 9	---/DCC	

										10 (0/1)	
414	26 14		2 3 4 5						8 9	---/DCC	
415	26 15	1 2 3 4 5							8 9	---/DCC	
416	26 16					6			8 9	---/DCC	
417	27 1	1				6			8 9	---/DCC	
418	27 2		2			6			8 9	---/DCC	
419	27 3	1 2				6			8 9	---/DCC	
420	27 4			3		6			8 9	---/DCC	
421	27 5	1		3		6			8 9	---/DCC	
422	27 6		2 3			6			8 9	---/DCC	
423	27 7	1 2 3				6			8 9	---/DCC	
424	27 8			4		6			8 9	---/DCC	
425	27 9	1		4		6			8 9	---/DCC	
426	27 10		2	4		6			8 9	---/DCC	
427	27 11	1 2		4		6			8 9	---/DCC	
428	27 12			3 4		6			8 9	---/DCC	
429	27 13	1		3 4		6			8 9	---/DCC	
430	27 14		2 3 4			6			8 9	---/DCC	
431	27 15	1 2 3 4				6			8 9	---/DCC	
432	27 16					5 6			8 9	---/DCC	
433	28 1	1				5 6			8 9	---/DCC	
434	28 2		2			5 6			8 9	---/DCC	
435	28 3	1 2				5 6			8 9	---/DCC	
436	28 4			3		5 6			8 9	---/DCC	
437	28 5	1		3		5 6			8 9	---/DCC	
438	28 6		2 3			5 6			8 9	---/DCC	
439	28 7	1 2 3				5 6			8 9	---/DCC	

													10 (0/1)							
440		28 8			4 5 6		8 9	---	/DCC											
441		28 9	1		4 5 6		8 9	---	/DCC											
442		28 10		2	4 5 6		8 9	---	/DCC											
443		28 11	1 2		4 5 6		8 9	---	/DCC											
444		28 12			3 4 5 6		8 9	---	/DCC											
445		28 13	1		3 4 5 6		8 9	---	/DCC											
446		28 14		2	3 4 5 6		8 9	---	/DCC											
447		28 15	1 2	3	4 5 6		8 9	---	/DCC											
448		28 16					7 8 9	---	/DCC											
449		29 1	1				7 8 9	---	/DCC											
450		29 2		2			7 8 9	---	/DCC											
451		29 3	1 2				7 8 9	---	/DCC											
452		29 4			3		7 8 9	---	/DCC											
453		29 5	1		3		7 8 9	---	/DCC											
454		29 6		2 3			7 8 9	---	/DCC											
455		29 7	1 2 3				7 8 9	---	/DCC											
456		29 8			4		7 8 9	---	/DCC											
457		29 9	1		4		7 8 9	---	/DCC											
458		29 10		2	4		7 8 9	---	/DCC											
459		29 11	1 2		4		7 8 9	---	/DCC											
460		29 12			3 4		7 8 9	---	/DCC											
461		29 13	1		3 4		7 8 9	---	/DCC											
462		29 14		2 3 4			7 8 9	---	/DCC											
463		29 15	1 2 3 4				7 8 9	---	/DCC											
464		29 16				5	7 8 9	---	/DCC											
465		30 1	1			5	7 8 9	---	/DCC											

													10 (0/1)							
466		30 2		2		5	7 8 9	---	/DCC											
467		30 3	1 2		5		7 8 9	---	/DCC											
468		30 4			3 5		7 8 9	---	/DCC											
469		30 5	1 3 5		7 8 9	---	/DCC													
470		30 6		2 3 5		7 8 9	---	/DCC												
471		30 7	1 2 3 5		7 8 9	---	/DCC													
472		30 8			4 5 7 8 9	---	/DCC													
473		30 9	1		4 5 7 8 9	---	/DCC													
474		30 10		2 4 5 7 8 9	---	/DCC														
475		30 11	1 2 4 5 7 8 9	---	/DCC															
476		30 12		3 4 5 7 8 9	---	/DCC														
477		30 13	1 3 4 5 7 8 9	---	/DCC															
478		30 14		2 3 4 5 7 8 9	---	/DCC														
479		30 15	1 2 3 4 5 7 8 9	---	/DCC															
480		30 16				6 7 8 9	---	/DCC												
481		31 1	1			6 7 8 9	---	/DCC												
482		31 2		2		6 7 8 9	---	/DCC												
483		31 3	1 2		6 7 8 9	---	/DCC													
484		31 4			3 6 7 8 9	---	/DCC													
485		31 5	1 3		6 7 8 9	---	/DCC													
486		31 6		2 3	6 7 8 9	---	/DCC													
487		31 7	1 2 3		6 7 8 9	---	/DCC													
488		31 8			4 6 7 8 9	---	/DCC													
489		31 9	1		4 6 7 8 9	---	/DCC													
490		31 10		2 4 6 7 8 9	---	/DCC														
491		31 11	1 2 4 6 7 8 9	---	/DCC															

												10 (0/1)		
492	31	12			3	4		6	7	8	9	---	/ DCC	
493	31	13	1		3	4		6	7	8	9	---	/ DCC	
494	31	14		2	3	4		6	7	8	9	---	/ DCC	
495	31	15	1	2	3	4		6	7	8	9	---	/ DCC	
496	31	16						5	6	7	8	9	---	/ DCC
497	32	1	1					5	6	7	8	9	---	/ DCC
498	32	2		2				5	6	7	8	9	---	/ DCC
499	32	3	1	2				5	6	7	8	9	---	/ DCC
500	32	4			3			5	6	7	8	9	---	/ DCC
501	32	5	1		3			5	6	7	8	9	---	/ DCC
502	32	6		2	3			5	6	7	8	9	---	/ DCC
503	32	7	1	2	3			5	6	7	8	9	---	/ DCC
504	32	8				4		5	6	7	8	9	---	/ DCC
505	32	9	1			4		5	6	7	8	9	---	/ DCC
506	32	10		2		4		5	6	7	8	9	---	/ DCC
507	32	11	1	2		4		5	6	7	8	9	---	/ DCC
508	32	12			3	4		5	6	7	8	9	---	/ DCC
509	32	13	1		3	4		5	6	7	8	9	---	/ DCC
510	32	14		2	3	4		5	6	7	8	9	---	/ DCC
511	32	15	1	2	3	4		5	6	7	8	9	---	/ DCC

Adressen größer 511 können nur im DCC Format ausgegeben werden und müssen mit der CV Programmierung über das Programmiergleis durchgeführt werden.

Addresses larger than 511 can only be assigned in the DCC format and must be done by programming a CV using the programming track.

Les adresses supérieures à 511 peuvent uniquement être éditées dans le format DCC et doivent être exécutées avec la programmation des CV via la voie de programmation.

Adressen groter dan 511 kunnen alleen in het DCC formaat gebruikt worden en moeten met de CV programmering via het programmeerspoor ingesteld worden.

Las direcciones superiores a 511 pueden mostrarse en el formato DCC y deben configurarse con la función Programación de CVs mediante la vía de programación.

Indirizzi maggiori di 511 possono essere assegnati solo nel formato DCC e si devono eseguire con la programmazione delle CV tramite il binario di programmazione.

Adresser överstigande 511 kan endast skrivas in i DCC-format och måste göras med CV-programmering med loket på programmeringspåret.

Adresser højere end 511 kan kun udtrykkes i DCC format og skal udføres med CV programmeringen via programmeringsporet.

Aufbau • Setup • Montage • Opbouwen • Montaje • Montaggio • Montering • Forsamling

Anschluss Programmiergleis

Connections for the Programming Track

Branchement voie de programmation

Aansluiten op het programmeerspoor

Conexión de la vía de programación

Collegamento del binario di programmazione

Anslutning till programmeringsspåret

Tilslutning programmeringsskinne

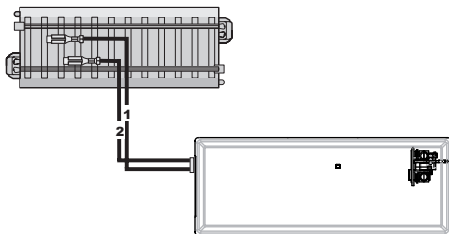

Märklin C-Gleis

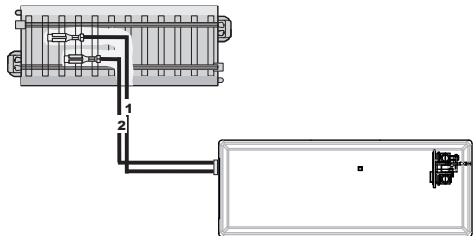

Kabelfarben

1 rot / red / rouge / rood / rojo / rosso / rød / rød

2 braun / brown / brun / bruin / marrón / marrone / brun / brun

Trix C-Gleis

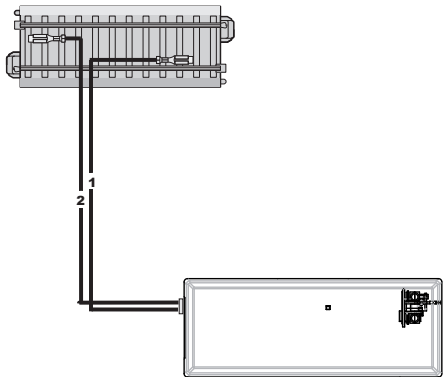

Märklin K-Gleis

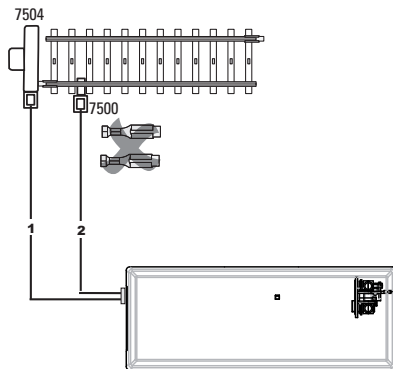

Zusätzlich benötigen Sie 1x 7504 u. 1x 7500

Additional materials required 1 x 7504 and 1 x 7500

Il vous faut en outre 1x 7504 u. 1x 7500

Daarnaast heeft u 1 x 7504 en 1x 7500 nodig Aislar y

Además, necesitará 1 x 7504 y 1 x 7500

Avete bisogno in aggiunta 1x 7504 e 1x 7500

Till detta erfordras 1 x 7504 och 1 x 7500

Der skal yderligere bruges 1x 7504 og 1x 7500

Befestigung am C-Gleis
Installation with C Track
Fixation à la voie C
Befestiging aan C-rail
Sujeción a la vía C
Fissaggio al binario C
Fastsättning vid C-räls
Fastgørelse på C-skinne

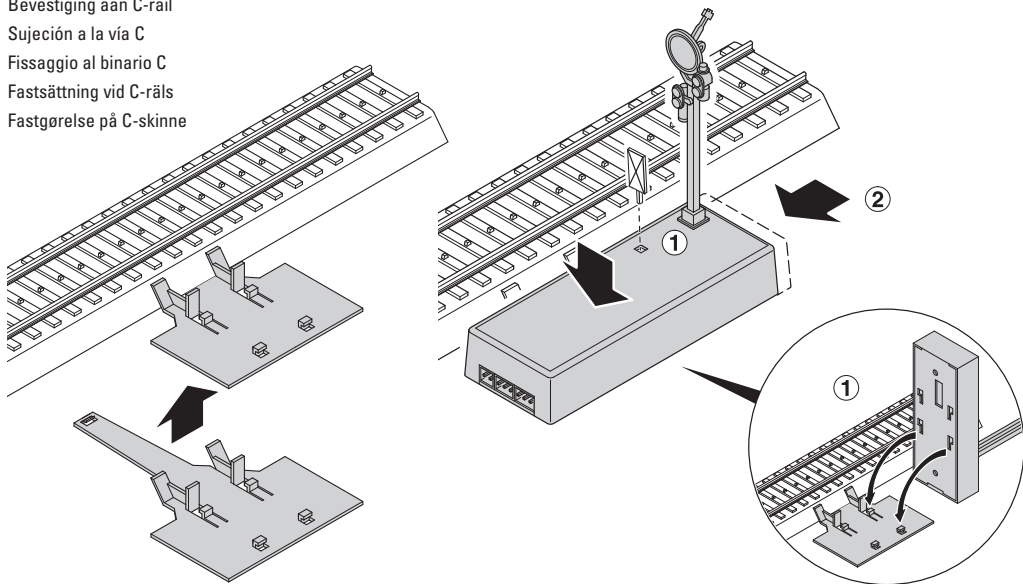

Befestigung am K-Gleis oder anderen Gleissystemen
Installation with K Track or Other Track Systems
Fixation à la voie K ou à d'autres systèmes de voies
Befestiging aan K-rail of ander railsysteem
Sujeción a la vía K u a otros sistemas de vías
Fissaggio al binario K oppure altri sistemi di binario
Fastsättning vid K-räls eller andra rälsystemer
Fastgørelse på K-skinne eller andre skinneresystemer

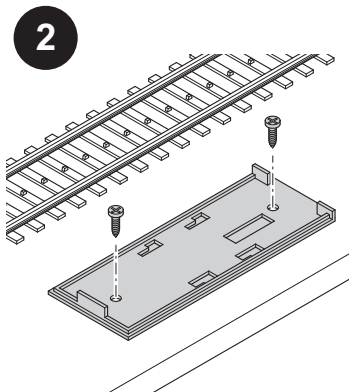
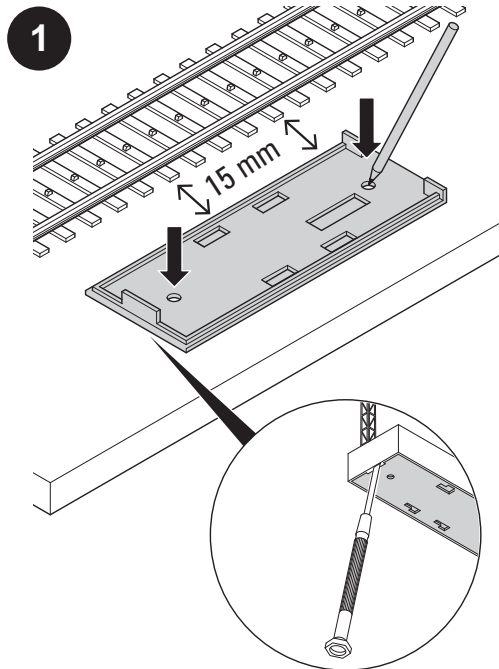

Mit beiliegender Bohrschablone markieren (Unterflurmontage).

Mark with the template included with the signal (Below-Baseboard Installation).

Marquer avec le patron de perçage ci-joint (Montage souterrain).

Met meegeleverde sjabloon markeren (Ondervloermontage).

Marcar con la plantilla de taladros adjunta (Montaje bajo el suelo).

Marcare con l'acclusa maschera di foratura (Montaggio sotto plancia).

Markera med hjälp av medföljande borrhåblon (Montage under anläggningen).

Markér med vedlagte boreskabelon (Underhængt montering).

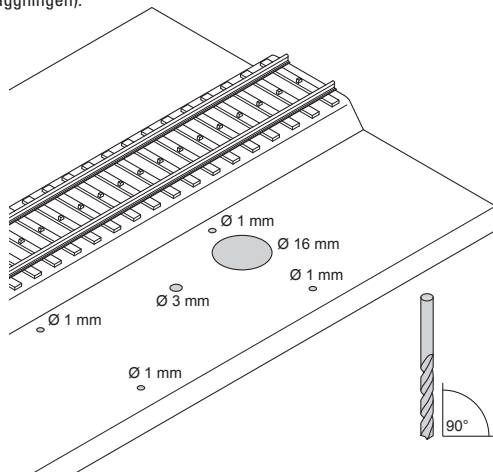
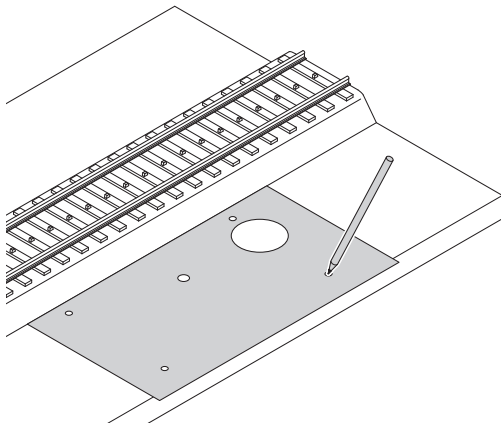

Steckteile entfernen

Remove detail parts

Ôter les connecteurs

Opsteekdelen verwijderen

Desmontaje de las piezas enchufables

Rimuovere gli elementi a innesto

Avlägsna insticksdelar

Fjern stikdele

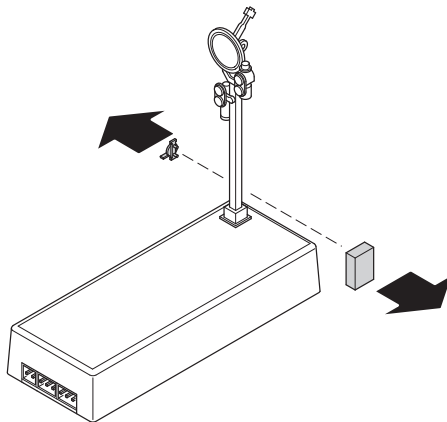

Unterflurmontage:

Below-Baseboard Installation:

Montage souterrain :

Ondervloermontage:

Montaje bajo el suelo:

Montaggio sotto plancia:

Montage under anläggningen:

Underhængt montering:

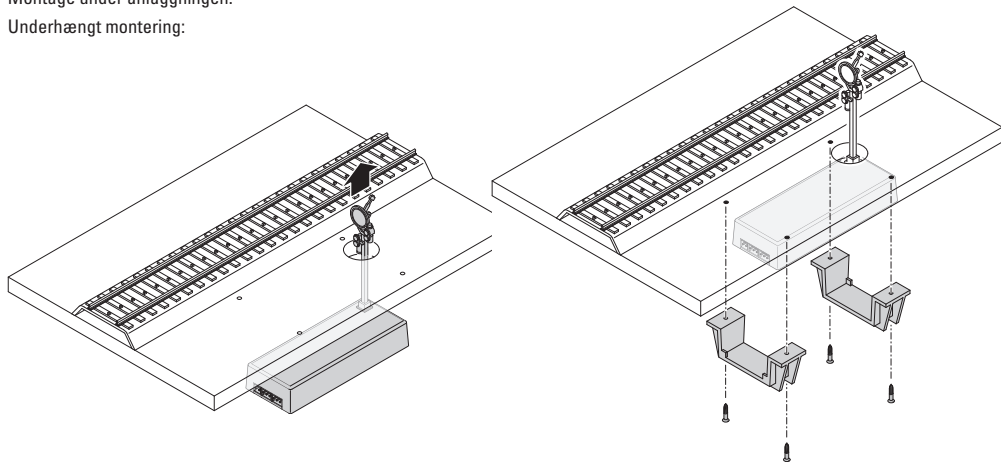

Abdeckung anbringen

Install the cover.

Poser le couvercle

Afdekking aanbrengen

Colocar la cubierta

Applicare il coperchio

Sätt på locket

Anbring afdækning

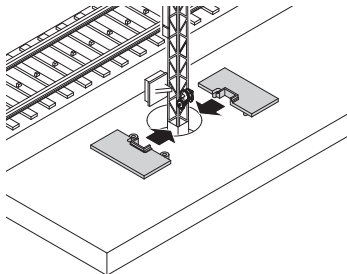

Steckteile nach erfolgter Unterflurmontage wieder anbringen.
Reinstall detail parts after completing below-baseboard installation.

Remonter les connecteurs après le montage souterrain.

Opsteekdelen na succesvolle ondervloermontage weer aanbrengen.

Colocar de nuevo las piezas enchufables una vez realizado el montaje bajo el suelo.

Applicare di nuovo gli elementi a innesto dopo avvenuto montaggio sotto plancia.

Efter montage av signalen under anläggningen sätts insticksdelarna tillbaka.

Anbring stikdele efter gennemført underhængt montering.

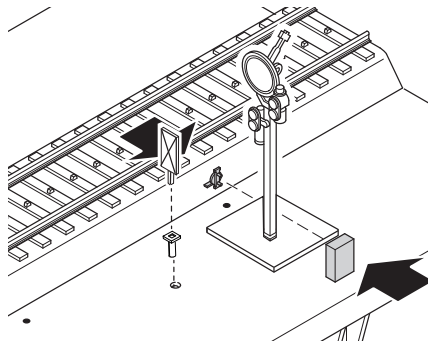

Bedeutung der Signaltafeln. Die Größe der Tafel für das Vorsignal wurde beim Vorbild nach dem vorhandenen Platz ausgewählt.

Significance of the signal signs. The size of the signs for the advance signal was selected in the prototype depending on the space present.

Signification des panneaux de signalisation. Sur le modèle, la taille du panneau pour le signal d'annonce a été choisie en fonction de la place disponible.

Betekenis van de seinborden. De grote van het bord voor het voorsein wordt, net al bij het voorbeeld, gekozen aan de hand van de beschikbare plaats.

Significado de los paneles de señal. En el modelo real, las dimensiones del panel para la señal avanzada se eligieron en función del espacio disponible.

Significato delle tabelle da segnali. La grandezza della tabella per il segnale di preavviso nel caso del prototipo veniva scelta in base allo spazio disponibile.

Signaltavlornas betydelse. Storleken på försignalens tavla väljs i verkligheten ut beroende på var och på vilken plats den ska placeras.

Signaltavlernes betydning. Tavlens størrelse til forsignalet blev udvalgt efter pladsen, der var til rådighed.



2 begriffiges Vorsignal	3 begriffiges Vorsignal	Verkürzter Abstand des Vorsignales zum Hauptsignal.
2-aspect advance signal	3-aspect advance signal	Shortened spacing between the advance signals and the home signal.
Signal d'annonce à 2 indications	Signal d'annonce à 3 indications	Distance réduite entre le signal d'annonce et le signal d'exécution.
2 standen voorsein	3 standen voorsein	Verkorte afstand van het voorsein tot het hoofdsein.
Señal avanzada de 2 aspectos	Señal avanzada de 3 aspectos	Distancia acortada entre la señal avanzada y la señal absoluta.
segnale di preavviso a 2 aspetti	segnale di preavviso a 3 aspetti	Distanza raccorciata del segnale di preavviso dal segnale principale.
2-läges försignal	3-läges försignal	Avkortat avstånd mellan försignal och huvudsignal.
2-koncept forsignal	3-koncept forsignal	Forkortet afstand mellem forsignalet og hovedsignalet.

**Aufkleber anbringen • Attach decals • Fixez les autocollants • Bevestig stickers •
Allega decalcomanie • Coloque las calcomanías • Bifoga dekaler • Vedhæft decals**

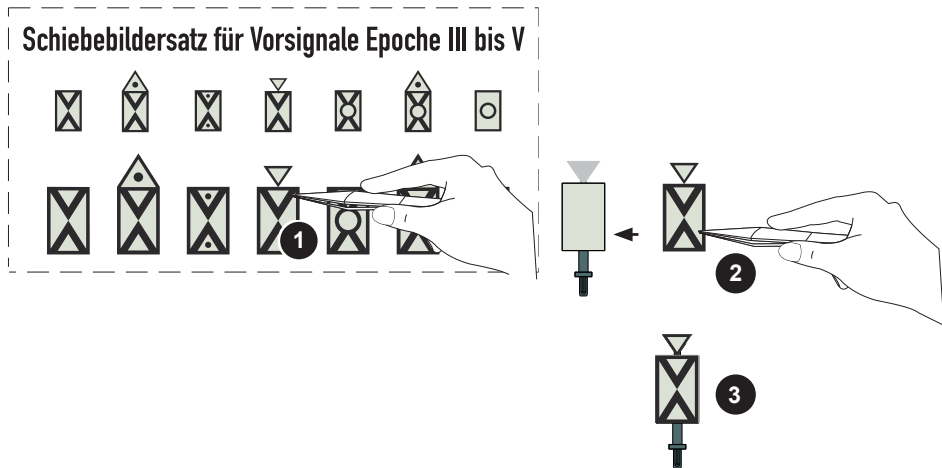

**Bohrschablone • Drilling Template • Gabarit de perçage • Boorsjabloon •
Plantilla • Maschera di Foratura • Borrschablon • Boreskabelon**

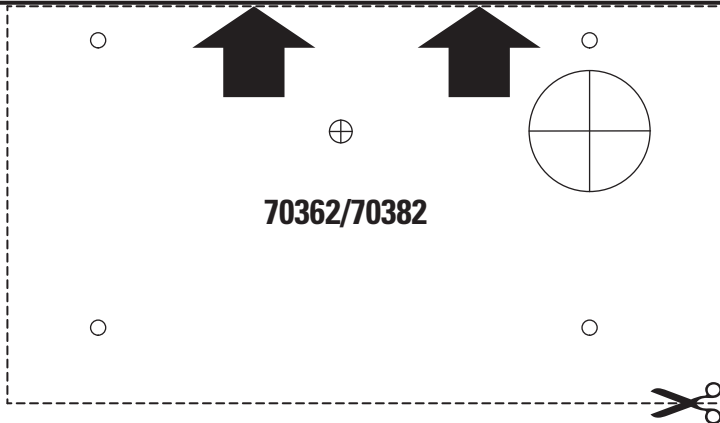
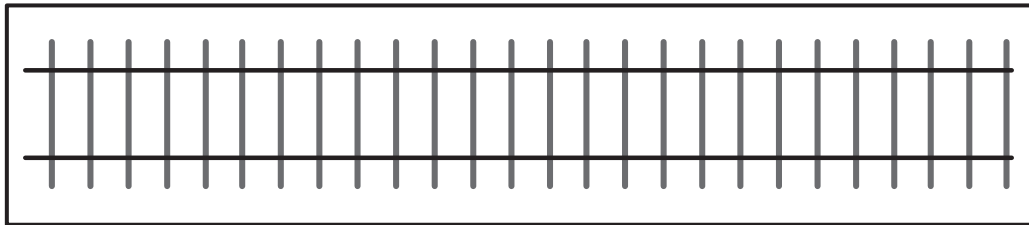

70362/70382

Due to different legal requirements regarding electro-magnetic compatibility, this item may be used in the USA only after separate certification for FCC compliance and an adjustment if necessary.

Use in the USA without this certification is not permitted and absolves us of any liability. If you should want such certification to be done, please contact us – also due to the additional costs incurred for this.

Gebr. Märklin & Cie. GmbH
Stuttgarter Straße 55 - 57
73033 Göppingen
Germany
www.maerklin.com



www.maerklin.com/en/imprint.html

295979/0718/Sc1Pw
Änderungen vorbehalten
© Gebr. Märklin & Cie. GmbH