



Fahrregler
51099

Inhaltsverzeichnis:	Seite
Sicherheitshinweise	4
Wichtige Hinweise	4
Technische Daten	5
Fahrregler anschließen	5
Bedienung	7

Table of Contents:	Page
Safety Notes	8
Important Notes	8
Technical Data	9
Connections for a locomotive controller	9
Operation	11

Sommaire :	Page	Índice:	Página
Remarques importantes sur la sécurité	12	Advertencias de seguridad	20
Informations importante	12	Notas importantes	20
Caractéristiques techniques	13	Datos técnicos	21
Raccorder le régulateur de marche	13	Conexión del regulador de marcha	21
Entretien et maintien	15	Manejo	23

Inhoudsopgave:	Pagina	Elenco del contenido:	Pagina
Veiligheidsvoorschriften	16	Avvertenze di sicurezza	24
Belangrijke aanwijzingen	16	Avvertenze importanti	24
Technische gegevens	17	Dati tecnici	25
Rijregelaar aansluiten	17	Collegamento del regolatore di marcia	25
Bediening	19	Azionamento	27

Sicherheitshinweise

Lesen Sie unbedingt die folgenden Sicherheitshinweise vor dem ersten Einsatz eines Fahrreglers:

- Das Fahrpult ist ausschließlich zum Gebrauch in trockenen Räumen bestimmt.
- Das Fahrpult ist kein Spielzeug. Es dient zum Betrieb der Modellbahnanlage.
- Zwei oder mehrere Fahrregler dürfen nicht elektrisch miteinander verbunden werden.
- Eine eingebaute Überlastsicherung schützt den Fahrregler bei Überlastung oder Kurzschluss vor Beschädigungen. Die Lok bleibt stehen. Nach Beseitigung der Störung schaltet sich der Fahrregler automatisch wieder ein.

Wichtige Hinweise

- Die Bedienungsanleitung ist Bestandteil des Produktes und muss deshalb aufbewahrt sowie bei Weitergabe des Produktes mitgegeben werden.
- Für Reparaturen wenden Sie sich bitte an Ihren LGB-Fachhändler.
- Gewährleistung und Garantie gemäß der beiliegenden Garantiekunde.
- Falscher Anschluss des Fahrpults führt zur Beschädigung des Geräts.
- Entsorgung: www.maerklin.com/en/imprint.html

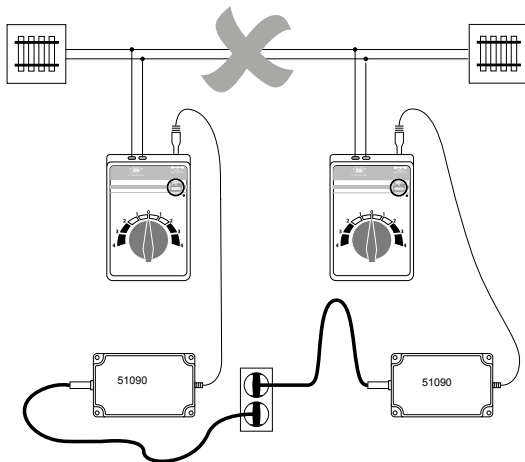

Technische Daten:

Eingang: 18 V DC

Ausgang: 0 - 16 V DC

max. 1 A

Fahrregler anschließen

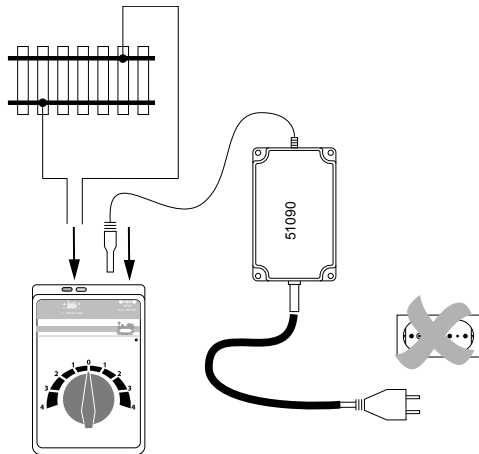
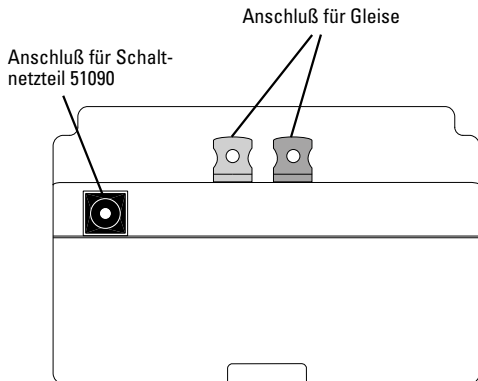

Fahrregler anschließen

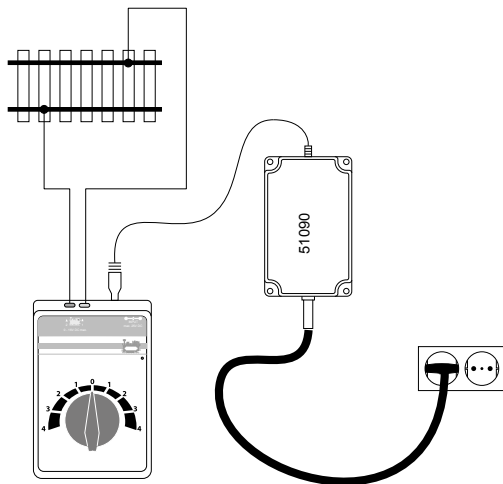

Zwei oder mehr Fahrregler anschließen

! Wenn mehr als ein Fahrregler angeschlossen wird, muß die Gleisanlage in entsprechende Stromabschnitte eingeteilt werden. Die Stromabschnitte müssen der Anzahl der eingesetzten Fahrregler entsprechen.

Die Stromabschnitte müssen gegenseitig isoliert werden. Verwenden Sie hierzu die Isolierschienenverbinder (10260) oder die Trenngleise (10152/11152).

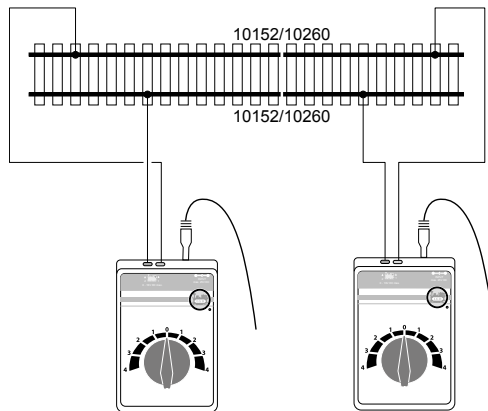

Bedienung

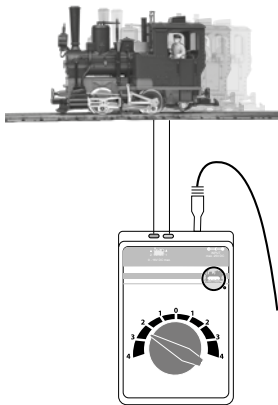

Lok fährt nach links

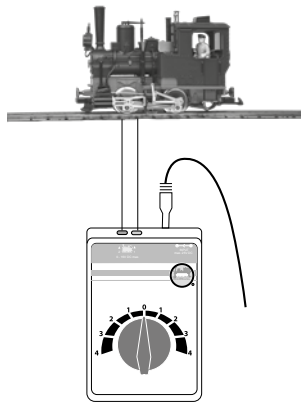

Lok steht

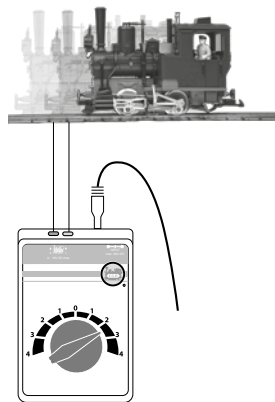

Lok fährt nach rechts

Safety Notes

Make sure you read the following safety notes before using this controller for the first time:

- This locomotive controller is designed for use only in dry areas.
- This locomotive controller is not a toy. It is used to operate a model railroad layout.
- Two or more locomotive controllers may not be connected with each other electrically.
- A built-in overload protection circuit protects each locomotive controller from damage in the case of an overload or a short circuit. A locomotive running on the track layout will come to a stop when the overload protection circuit is activated. The locomotive controller comes back on automatically after the overload or short circuit has been corrected.

Important Notes

- The operating instructions are a component part of the product and must therefore be kept in a safe place as well as included with the product, if the latter is given to someone else.
- Please see your authorized LGB dealer for repairs.
- The warranty card included with this product specifies the warranty conditions.
- Incorrect hookup of this locomotive controller will damage it.
- Disposing: www.maerklin.com/en/imprint.html

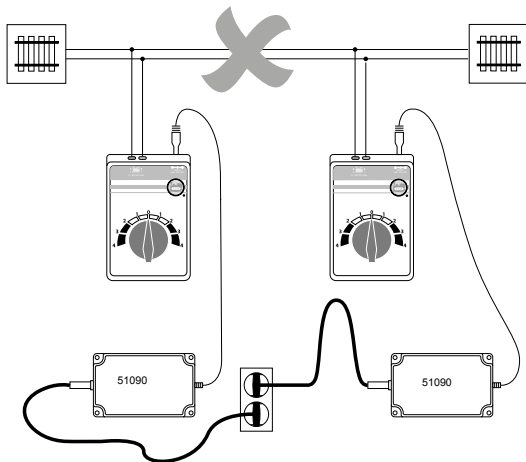

Technical Data:

Input Voltage: 18 V DC

Output Voltage: 0 - 16 V DC

max. 1 A

Connections for a locomotive controller

Connections for the
51090 switched mode
power pack

Connections to the track

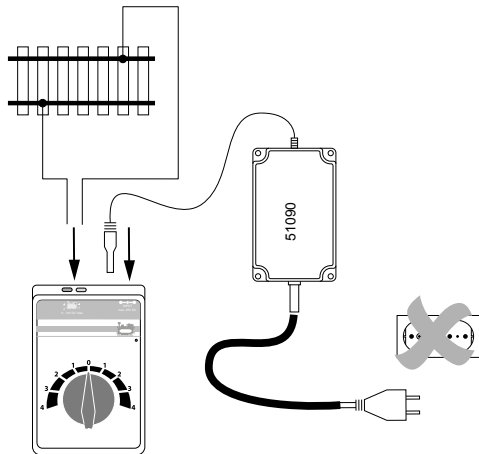
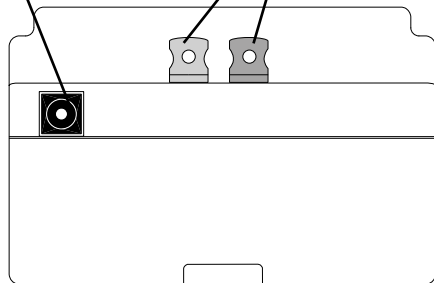

Connections for a locomotive controller

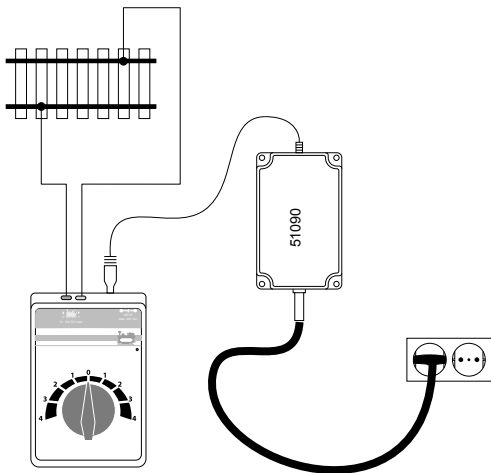

Connections for two or more locomotive controllers

- When more than one locomotive controller is to be connected to the layout, then the layout must be divided up into appropriate power circuits. The power circuits must be equal to the number of locomotive controllers to be used.

The power circuits must be insulated from each other. Use the insulated rail joiners (10260) or the separation tracks (10152/11152) to do this.

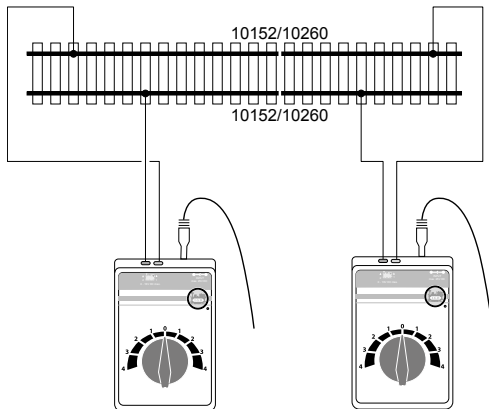

Operation

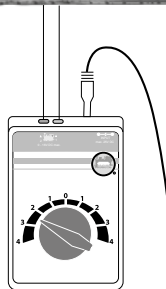

Locomotive going to the left

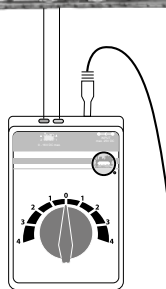

Locomotive stopped

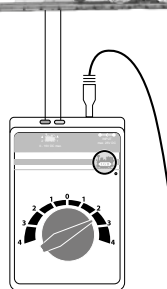
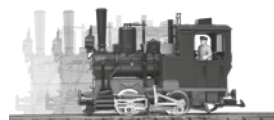

Locomotive going to the right

Remarques importantes sur la sécurité

Avant la première utilisation du régulateur de marche, lire impérativement les indications de sécurité suivantes:

- Le régulateur de marche est conçu pour être utilisé exclusivement dans des endroits secs.
- Le pupitre de commande n'est pas un jouet. Il sert à l'exploitation du réseau miniature.
- Le raccordement électrique de deux ou plusieurs régulateurs de marche est absolument exclu.
- En cas de surcharge ou de court-circuit, le régulateur est protégé par un dispositif de sécurité intégré. La locomotive est immobilisée. Une fois la cause de la surcharge ou du court-circuit éliminée, le régulateur est automatiquement remis sous tension.

Information importante

- La notice d'utilisation fait partie intégrante du produit ; elle doit donc être conservée et, le cas échéant, transmise avec le produit.
- Pour toute réparation adressez-vous à votre détaillant-spécialiste LGB.
- Garantie légale et garantie contractuelle conformément au certificat de garantie ci-joint.
- Un raccordement incorrect du pupitre de commande risque d'endommager l'appareil.
- Elimination : www.maerklin.com/en/imprint.html

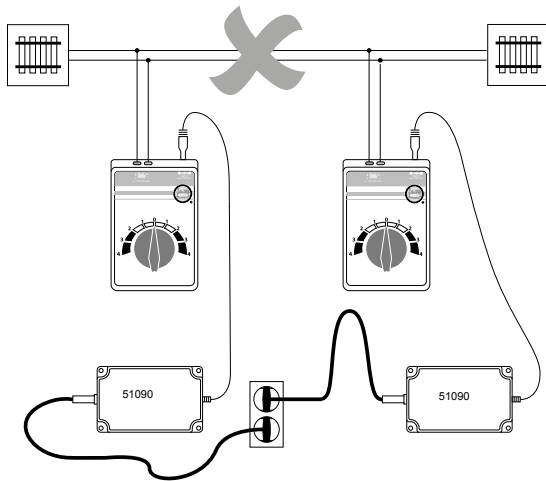

Caractéristiques techniques:

Tension d'entrée: 18 V DC

Tension de sortie: 0 - 16 V DC
max. 1 A

Raccorder le régulateur de marche

Connexion pour le
convertisseur réf. 51090

Connexion pour les
éléments de voie

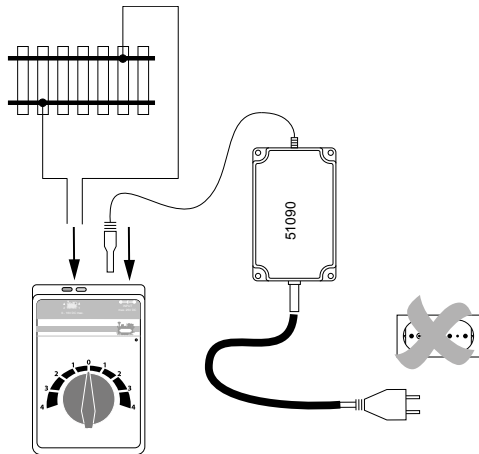
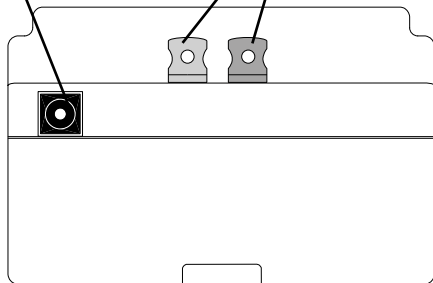

Raccorder le régulateur de marche

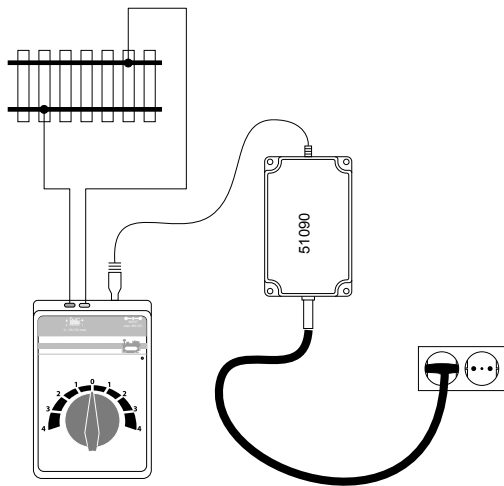

Raccorder deux ou plusieurs régulateurs de marche

- ! Pour raccorder plus d'un régulateur de marche, le réseau de voie doit être divisé en autant de cantons correspondants.
- Le nombre de cantons doit correspondre au nombre des régulateurs de marche utilisés.

Les cantons doivent être isolés les uns des autres. A cet effet, utilisez les éclisses isolantes (10260) ou les rails de coupure (10152/11152).

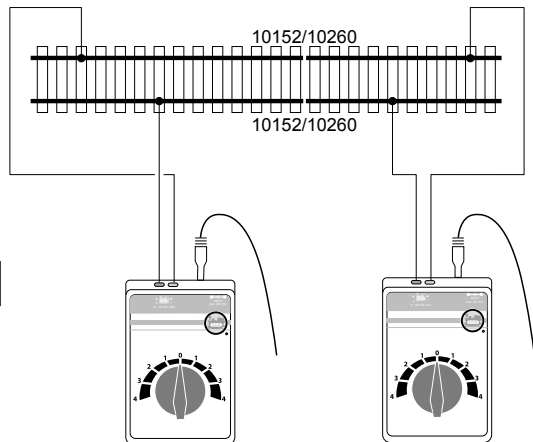

Entretien et maintien

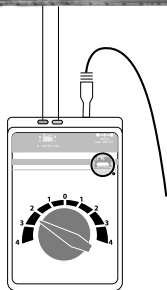

Locomotive roule vers la gauche

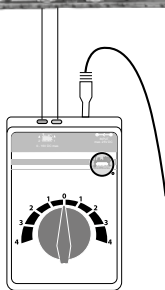

Locomotive arrêtée

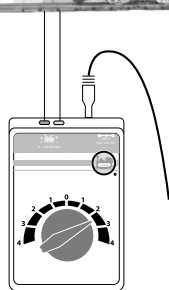

Locomotive roule vers la droite

Veiligheidsvoorschriften

Lees, voordat u het apparaat gaat gebruiken, de volgende veiligheidsvoorschriften aandachtig door:

- De rijregelaar is uitsluitend bestemd voor het gebruik in droge ruimtes.
- De rijregelaar is geen speelgoed. Het dient voor het besturen van een modelbaan.
- Twee of meerdere rijregelaars mogen niet elektrisch met elkaar verbonden zijn.
- Een ingebouwde overbelastingsbeveiliging beschermt de rijregelaar tegen overbelasting of kortsluiting. De loc blijft stilstaan. Nadat de storing is opgeheven, schakelt de rijregelaar automatisch weer in.

Belangrijke aanwijzing

- De gebruiksaanwijzing is een essentieel onderdeel van het product en dient daarom bewaard te worden en bij het overdragen van het product meegegeven te worden.
- Voor reparaties kunt u zich tot Uw LGB handelaar wenden.
- Vrijwaring en garantie overeenkomstig het bijgevoegde garantiebewijs.
- Un raccordement incorrect du pupitre de commande risque d'endommager l'appareil.
- Elimination : www.maerklin.com/en/imprint.html

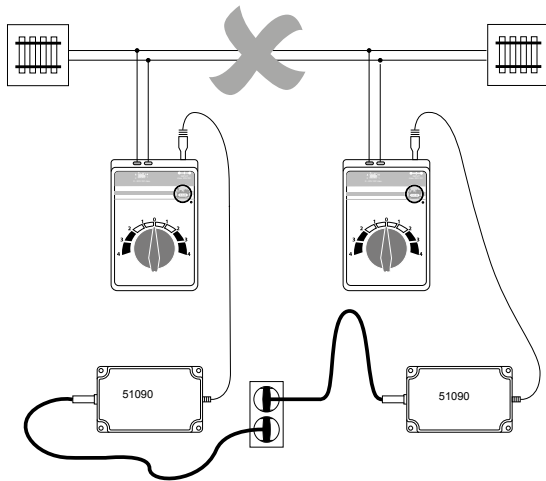

Technische gegevens:

Ingangsspanning: 18 V DC

Uitgangsspanning: 0 - 16 V DC
max. 1 A

Rijregelaar aansluiten

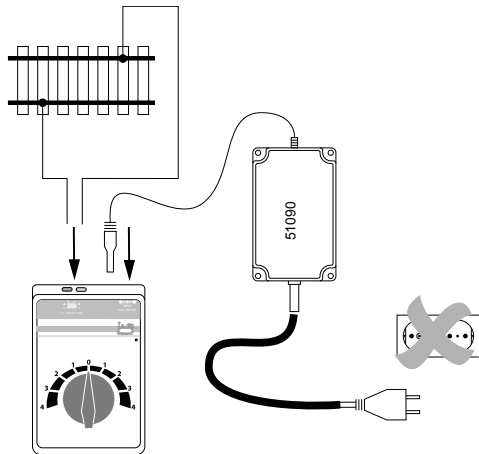
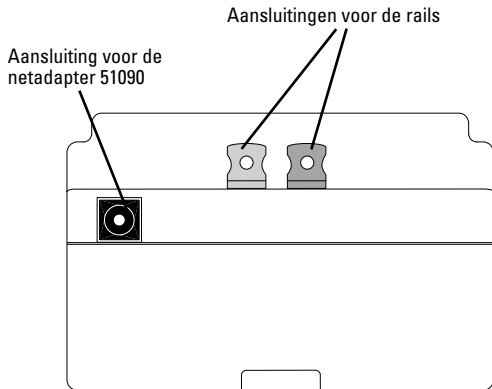

Rijregelaar aansluiten

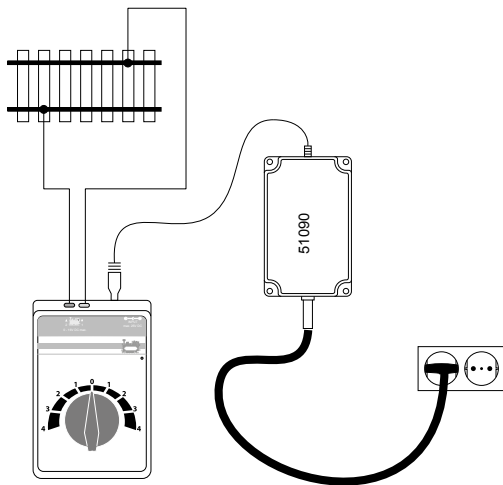

Twee of meer rijregelaar aansluiten

! Als er meer dan één rijregelaar wordt aangesloten moet de modelbaan in meerdere stroomkringen opgedeeld worden. Het aantal stroomkringen moet overeenkomen met het aantal rijregelaars.

De stroomkringen moeten onderling geïsoleerd worden. Gebruik daarvoor de geïsoleerde raillassen (10260) of de scheidingsrails (10152/11152).

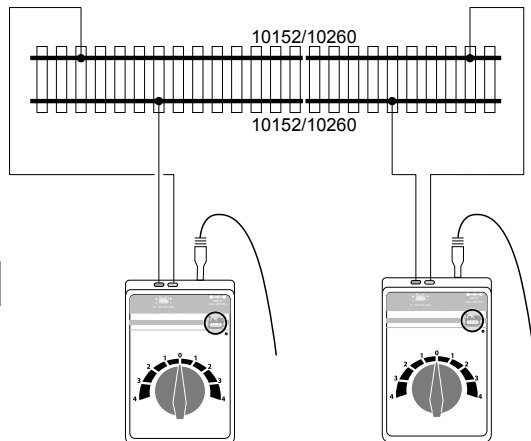

Bediening

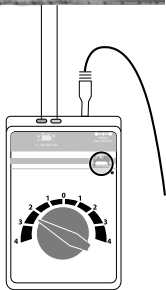

Loc rijdt naar links

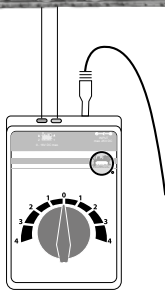

Loc staat stil

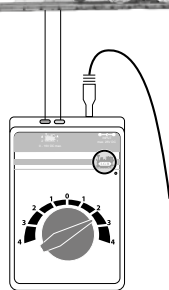

Loc rijdt naar rechts

Advertencias de seguridad

Antes del primer uso de un regulador de marcha es imprescindible leer las siguientes advertencias de seguridad.

- El pupitre de conducción se ha concebido para su uso exclusivamente en recintos secos.
- El pupitre de conducción no es un juguete. Sirve para la explotación de la maqueta de trenes.
- No está permitido conectar eléctricamente entre sí dos o más reguladores de marcha.
- Una protección contra sobrecargas incorporada protege de posibles daños al regulador de marcha en el caso de sobrecarga o cortocircuito. La locomotora permanece en reposo. Tras eliminar la avería, el regulador de marcha vuelve a conectarse automáticamente.

Notas importantes

- Las instrucciones de empleo y el embalaje forman parte íntegra del producto y, por este motivo, deben guardarse y entregarse junto con el producto en el caso de venderlo o transmitirlo a otro.
- Para reparaciones contacte con su proveedor LGB especializado.
- Responsabilidad y garantía conforme al documento de garantía que se adjunta.
- Una conexión incorrecta del pupitre de conducción provoca daños al aparato.
- Eliminación: www.maerklin.com/en/imprint.html

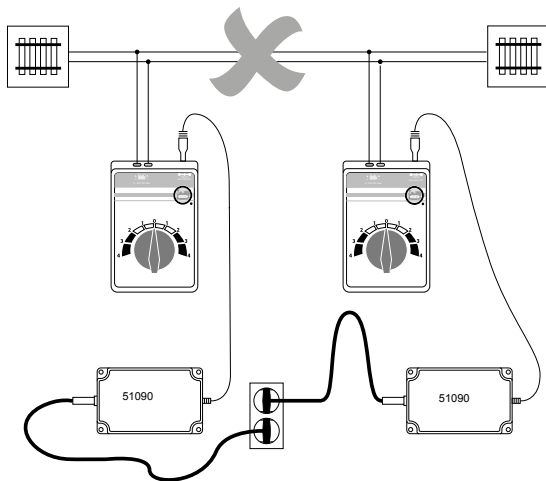

Datos técnicos:

Tension de entrada: 18 V DC

Tension de salida: 0 - 16 V DC

max. 1 A

Conexión del regulador de marcha

Conexión para la fuente de alimentación conmutada 51090

Conexión para las vías

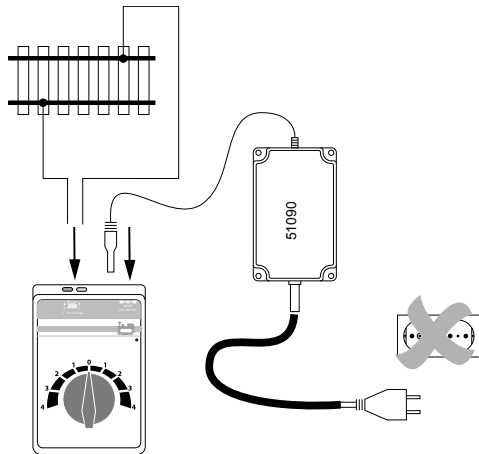
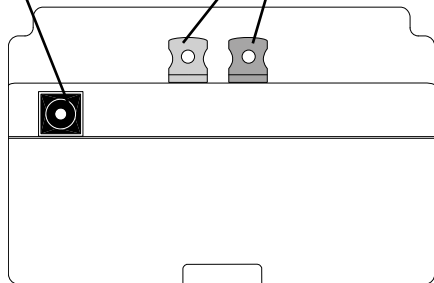

Conexión del regulador de marcha

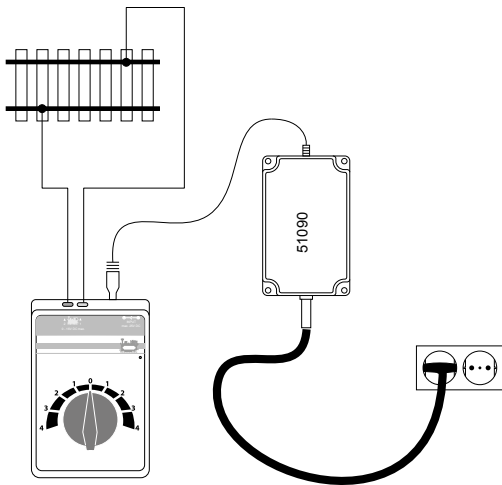

Conexión de dos o más reguladores de marcha

! Si se conecta más de un regulador de marcha, es preciso subdividir la instalación de vías en otros tantos tramos de alimentación eléctrica. Los tramos de alimentación eléctrica deben coincidir con el número de reguladores de marcha utilizados.

Los tramos de alimentación eléctrica deben aislarse mutuamente. Para tal fin, utilizar los conectores de carriles aislantes (10152/10260) o las vías de seccionamiento (10152/11152).

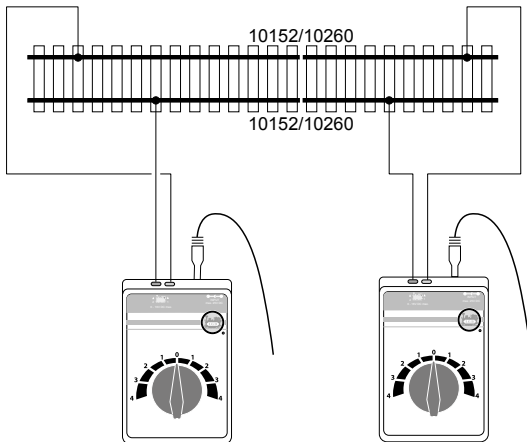

Manejo

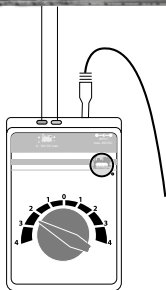

Locomotora va a la izquierda

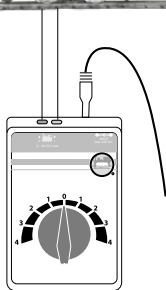

Locomotora sí detuvo

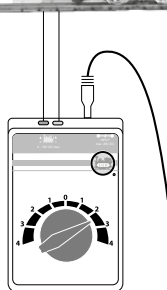

Locomotora va a la derecha

Avvertenze di sicurezza

Vogliate leggere assolutamente le seguenti avvertenze di sicurezza prima del primo impiego di un regolatore di marcia:

- Tale quadro di comando della marcia è progettato esclusivamente per l'utilizzo in ambienti asciutti.
- Tale quadro di comando della marcia non è affatto un giocattolo. Esso serve al funzionamento dell'impianto di ferrovia in miniatura.
- Due o più regolatori di marcia non possono venire collegati elettricamente tra loro.
- Una sicurezza incorporata contro il sovraccarico protegge tale regolatore di marcia da danneggiamenti in caso di carico eccessivo oppure corto circuito. La locomotiva rimane ferma. Dopo eliminazione dell'inconveniente il regolatore di marcia si attiva di nuovo automaticamente.

Avvertenze importanti

- Le istruzioni di impiego costituiscono parte integrante del prodotto e devono pertanto venire conservate, nonché consegnate insieme in caso di cessione del prodotto ad altri.
- Per le riparazioni, contrattare il rivenditore LGB.
- Prestazioni di garanzia e garanzia in conformità all'accluso certificato di garanzia.
- Un errato collegamento del quadro di comando della marcia conduce al danneggiamento di tale apparato.
- Smaltimento: www.maerklin.com/en/imprint.html

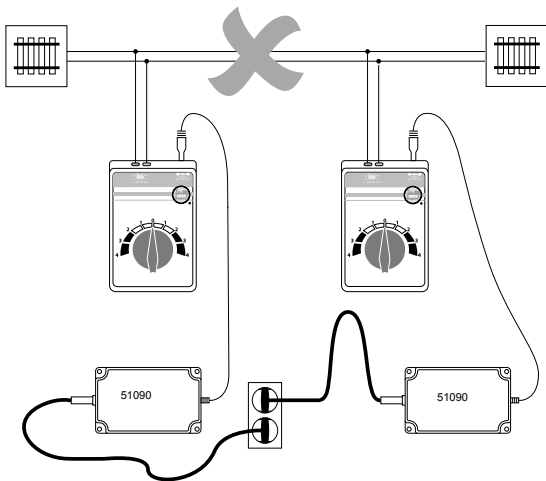

Dati tecnici:

Tensione di ingresso: 18 V DC

Tensione di uscita: 0 - 16 V DC
max. 1 A

Collegamento del regolatore di marcia

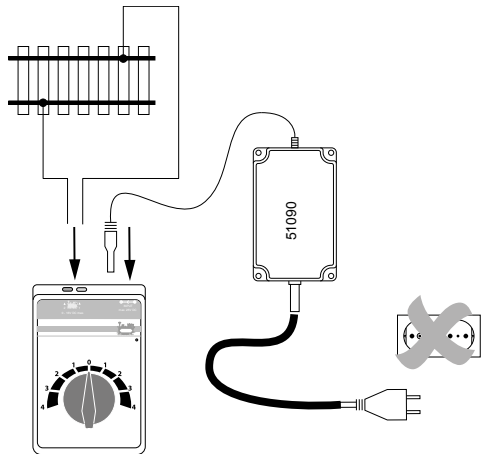
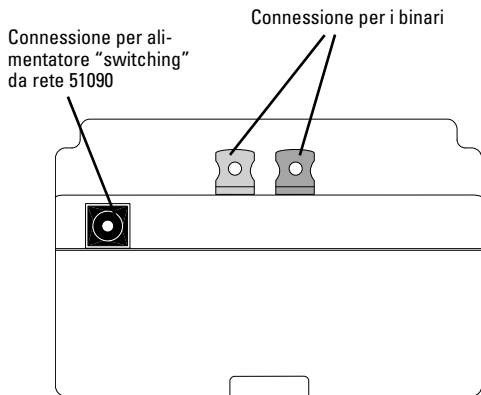

Collegamento del regolatore di marcia

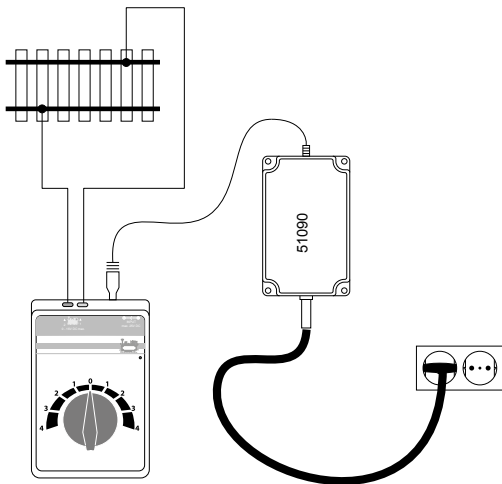

Collegamento di due o più regolatori di marcia

Qualora venga collegato più di un solo regolatore di marcia, l'impianto di binari deve venire suddiviso in corrispondenti sezioni di alimentazione. Tali sezioni di alimentazione devono corrispondere al numero dei regolatori di marcia impiegati.

Le sezioni di alimentazione devono venire isolate reciprocamente. Vogliate utilizzare a questo scopo delle giunzioni di rotaia isolate (10260) oppure i binari di sezionamento (10152/11152).

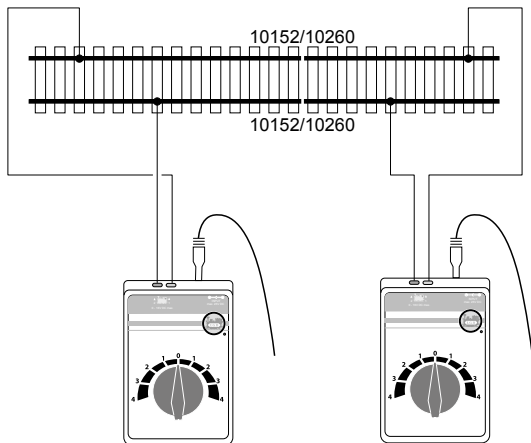

Azionamento

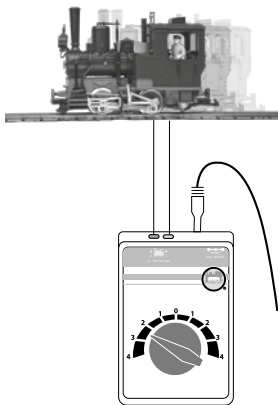

La locomotiva viaggia verso sinistra

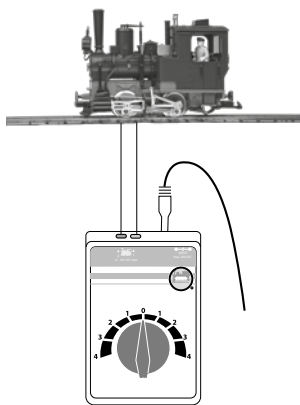

La locomotiva sta ferma

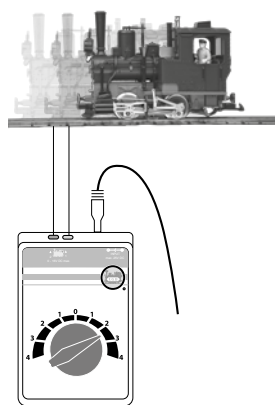

La locomotiva viaggia verso destra

Gebr. Märklin & Cie. GmbH
Stuttgarter Straße 55 - 57
73033 Göppingen
Germany
www.lgb.de



www.maerklin.com/en/imprint.html

168232/0521/Sc5Sg
Änderungen vorbehalten
© by Gebr. Märklin & Cie. GmbH