

Modellbau Laffont

PROFESSIONAL LASERCUT

Art.-Nr. Z7401



Art.-Nr. 9801

Bausatz Maßstab 1:220 (Spur Z)

Grandhotel "Excelsior"

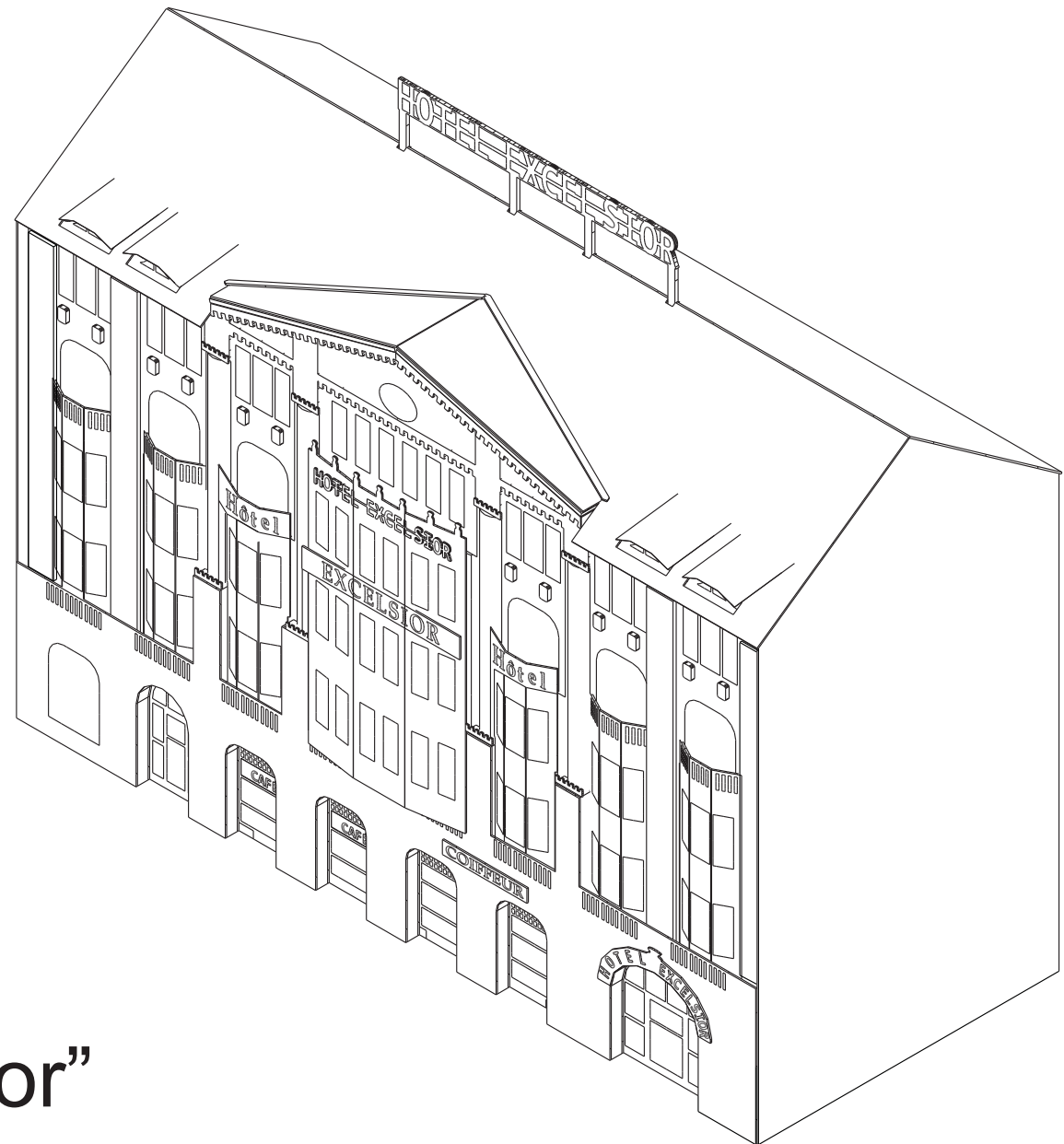

Modellbauartikel, kein Kinderspielzeug, nicht für Kinder unter 15 Jahren

Hinweise für den Zusammenbau:

Der Bausatz besteht aus durchgefärbtem Architektur-Hartkarton in matter, realistischer Farbgebung und benötigt daher keine Lackierung, kann jedoch z.B. mit Pulverfarben oder vielen anderen Farben lackiert oder gealtert werden.

Die Anhängpunkte der Bauteile sind z.B. mit einem Cutter zu lösen. Für die Verklebung wird handelsüblicher Express-Holzleim empfohlen. Der Kleber sollte dünn und flächig verteilt werden. Bei kleinen Bauteilen kann der Kleber z.B. mit einem Zahnstocher aufgetragen werden. Für die Verklebung der Fensterfolie wird Alleskleber empfohlen. Die Bauteile sollten nach dem Verkleben einige Minuten mit Gewichten beschwert oder mit Klammern zusammengepresst werden.

Notes for assembly:

The kit consists of solid colored architectural hard cardboard in matt, realistic coloring and therefore does not require painting, but may e.g. be painted or aged with powder paints or many other colors.

The attachment points of the components are e.g. to solve with a cutter. For the gluing commercial wood glue is recommended. The glue should be thin and distributed over a wide area. For small components, the adhesive may e.g. with a toothpick be applied. For gluing the window foil, all-purpose glue is recommended. The components should be weighted with weights for a few minutes after bonding or with clamps are pressed together.

Inhalt:

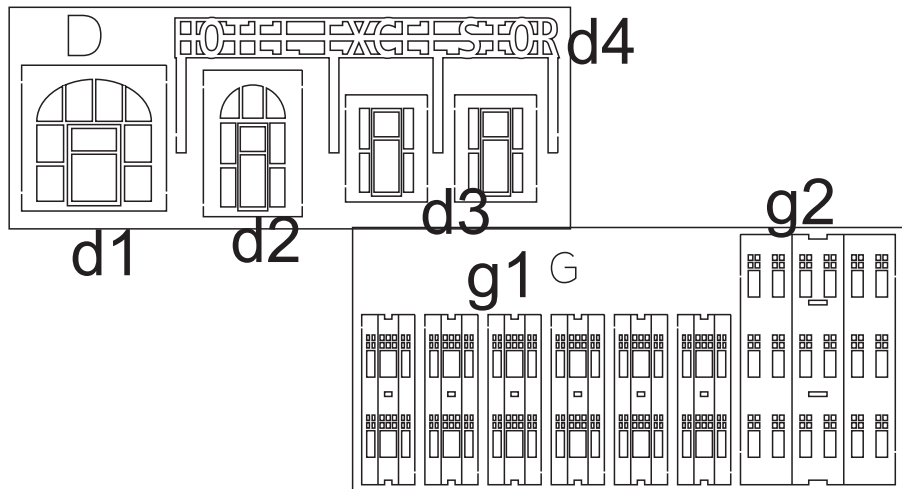
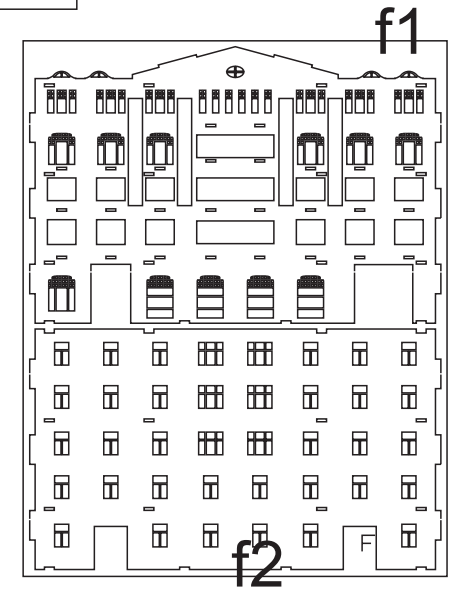
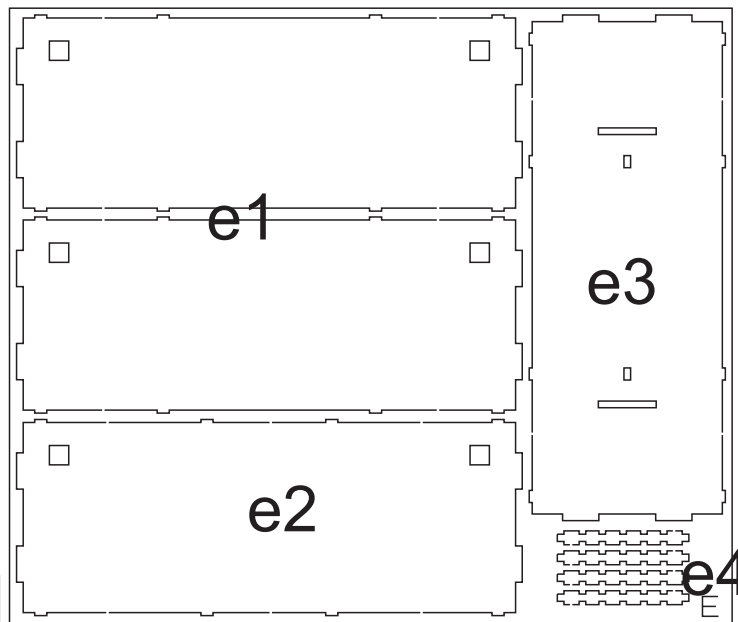
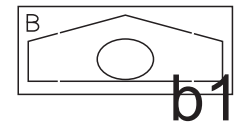
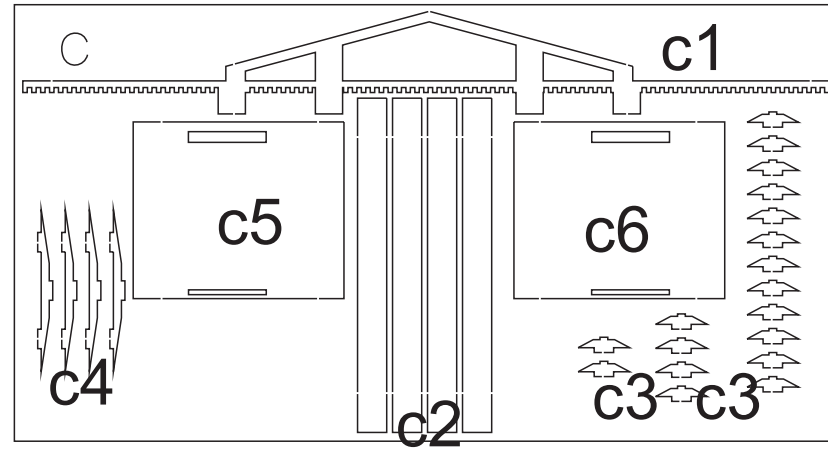
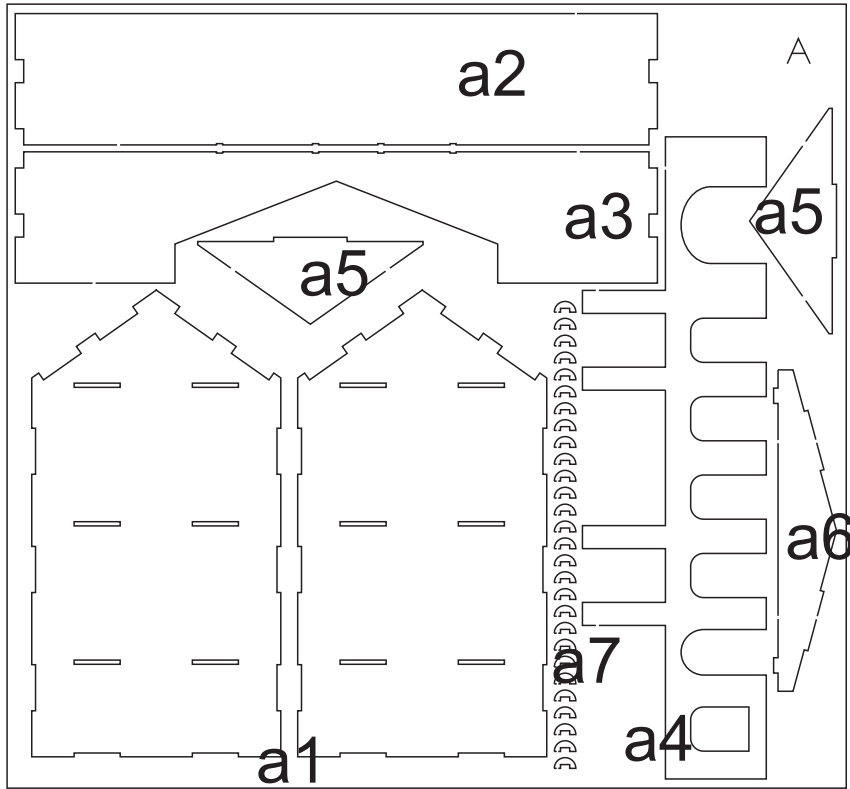

Inhalt:

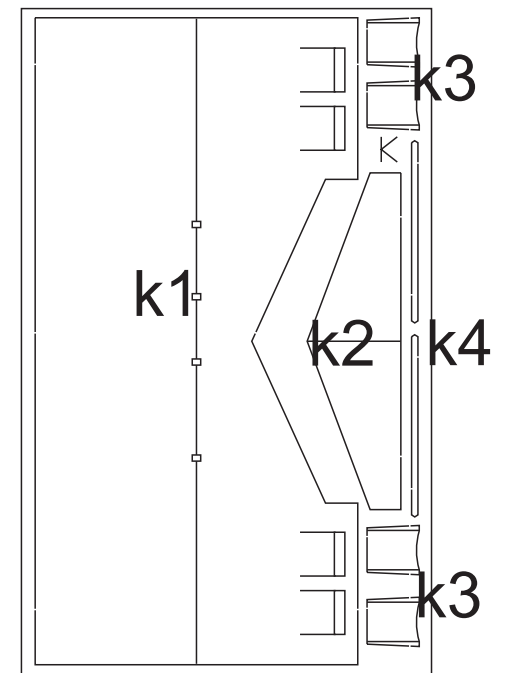
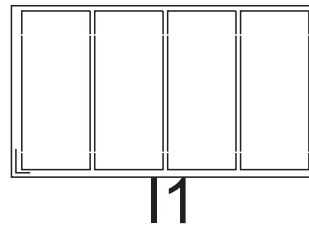
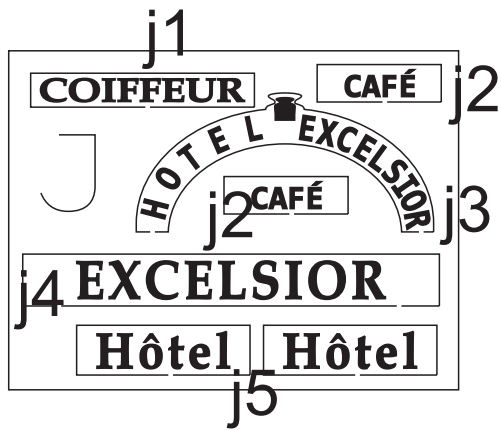
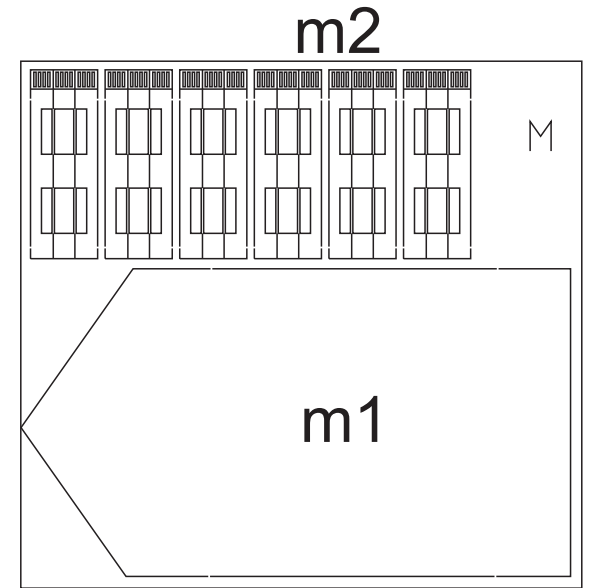
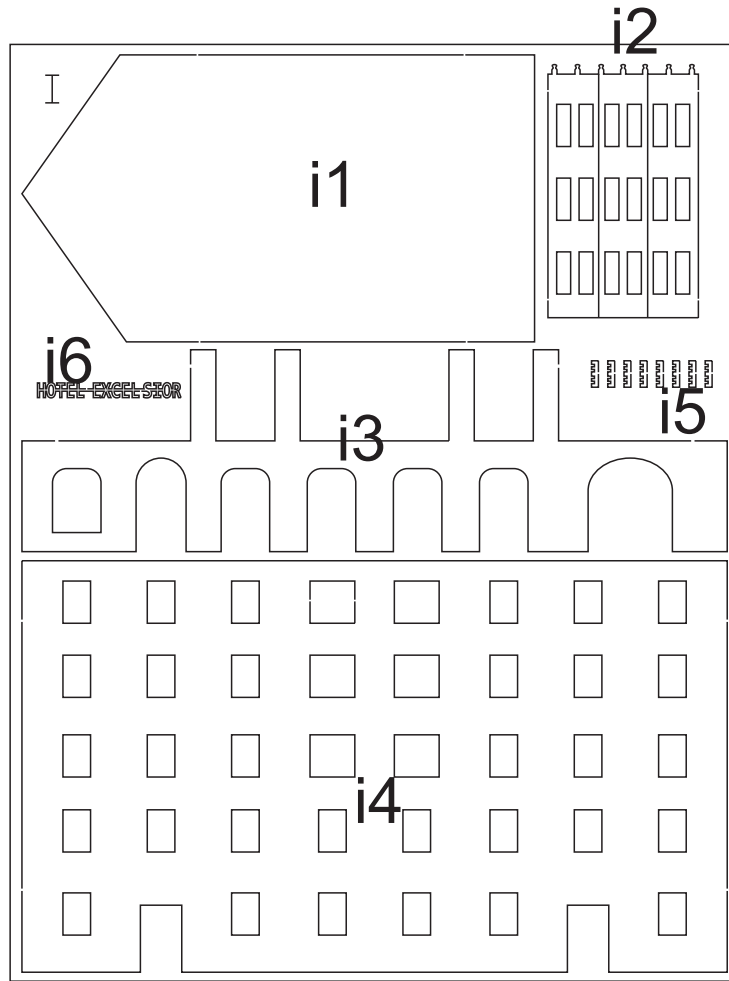
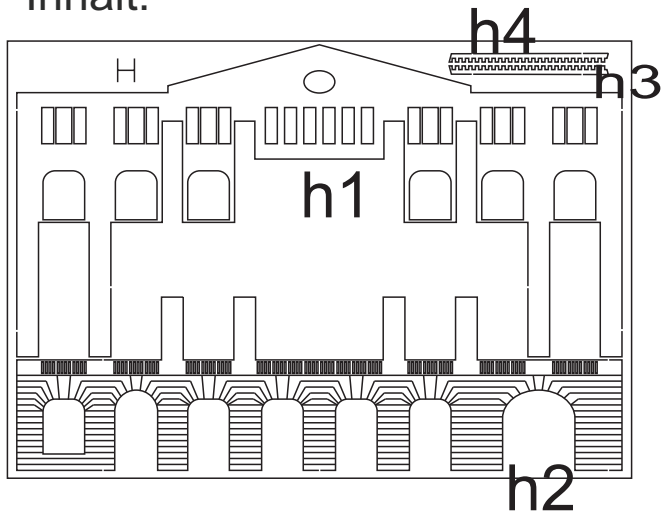

zuerst Folie  
zuschneiden  
und von innen  
aufkleben  
*First film cut to size and  
stick from inside*

zuerst Folie  
zuschneiden  
und von innen  
aufkleben  
*First film cut to size and  
stick from inside*

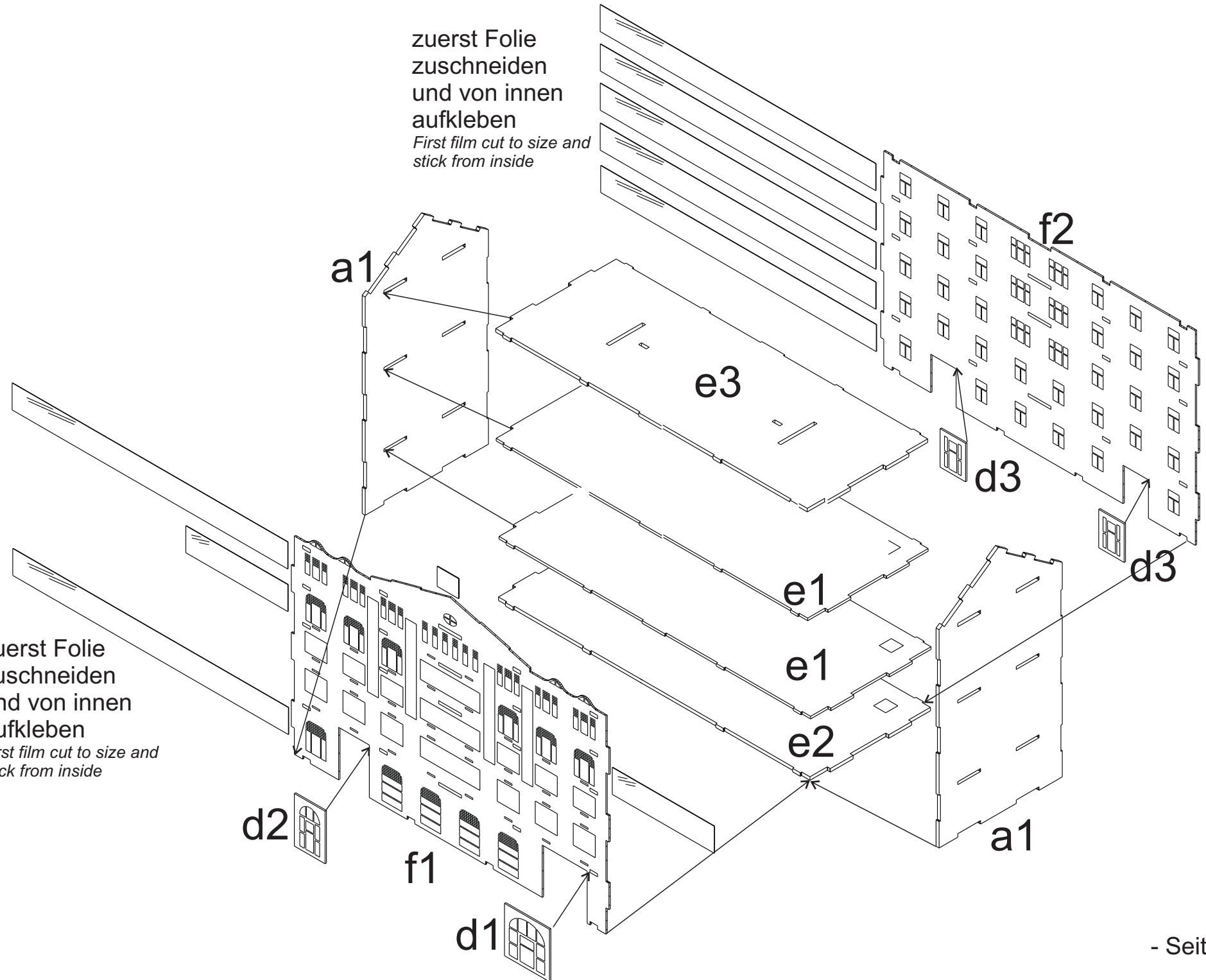

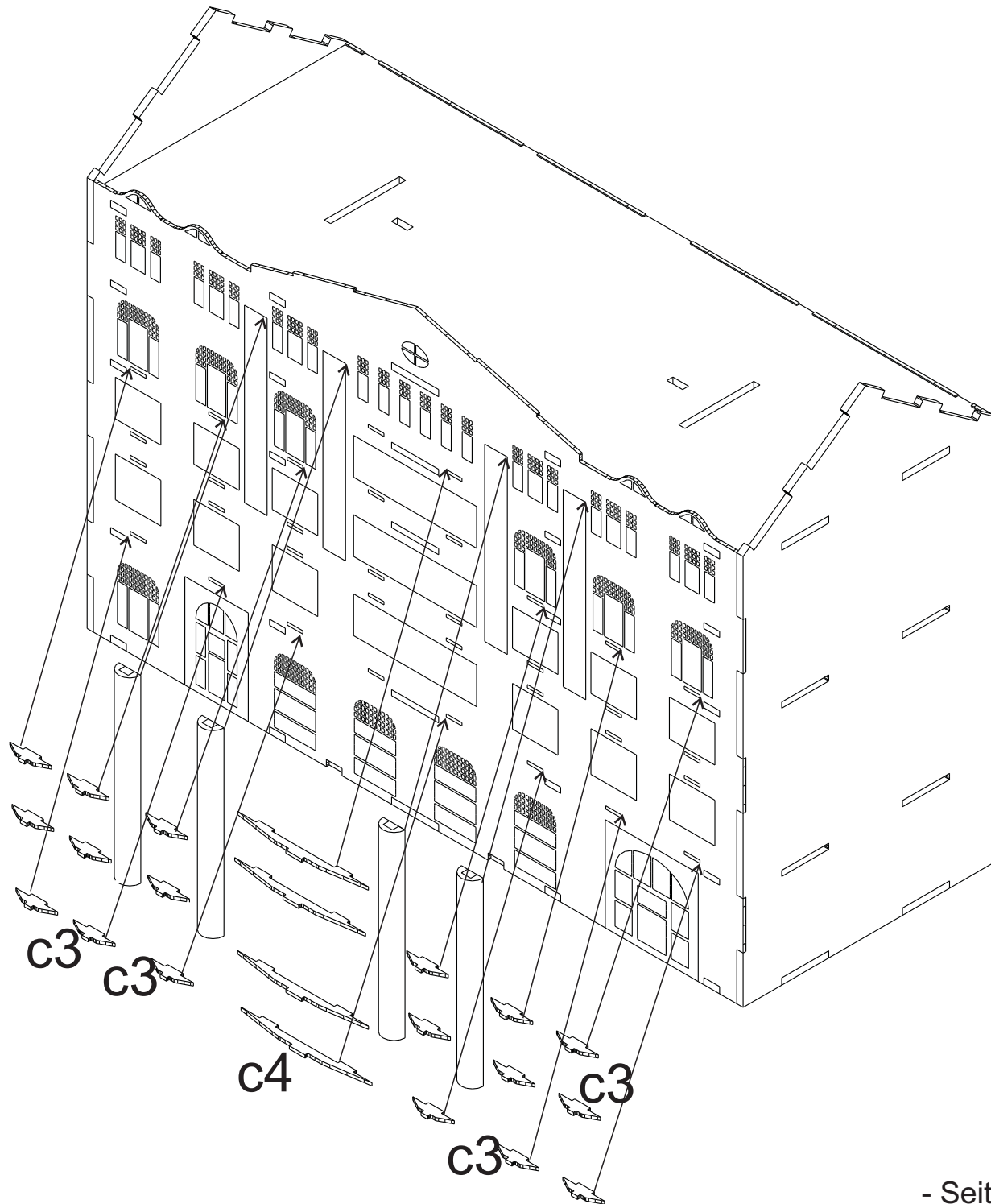
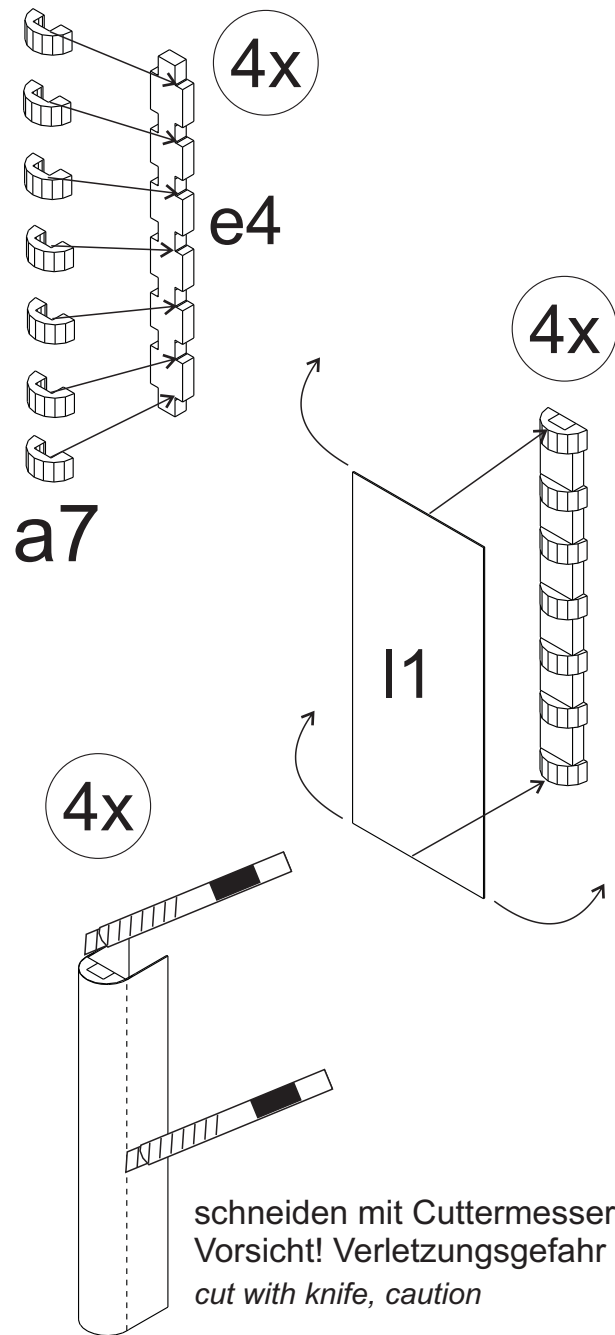

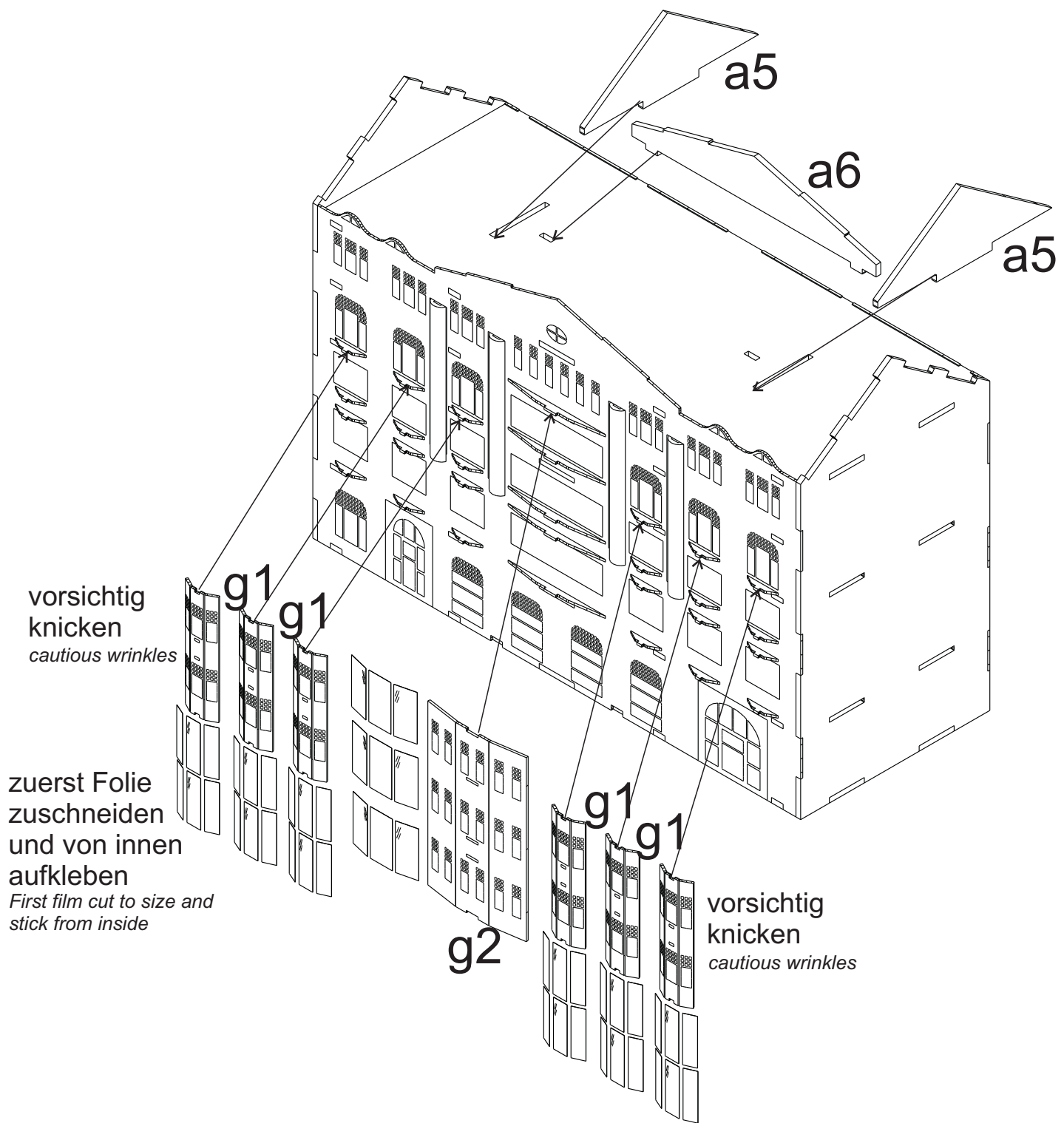

vorsichtig knicken  
cautious wrinkles

zuerst Folie zuschneiden  
und von innen aufkleben  
First film cut to size and  
stick from inside

vorsichtig knicken  
cautious wrinkles

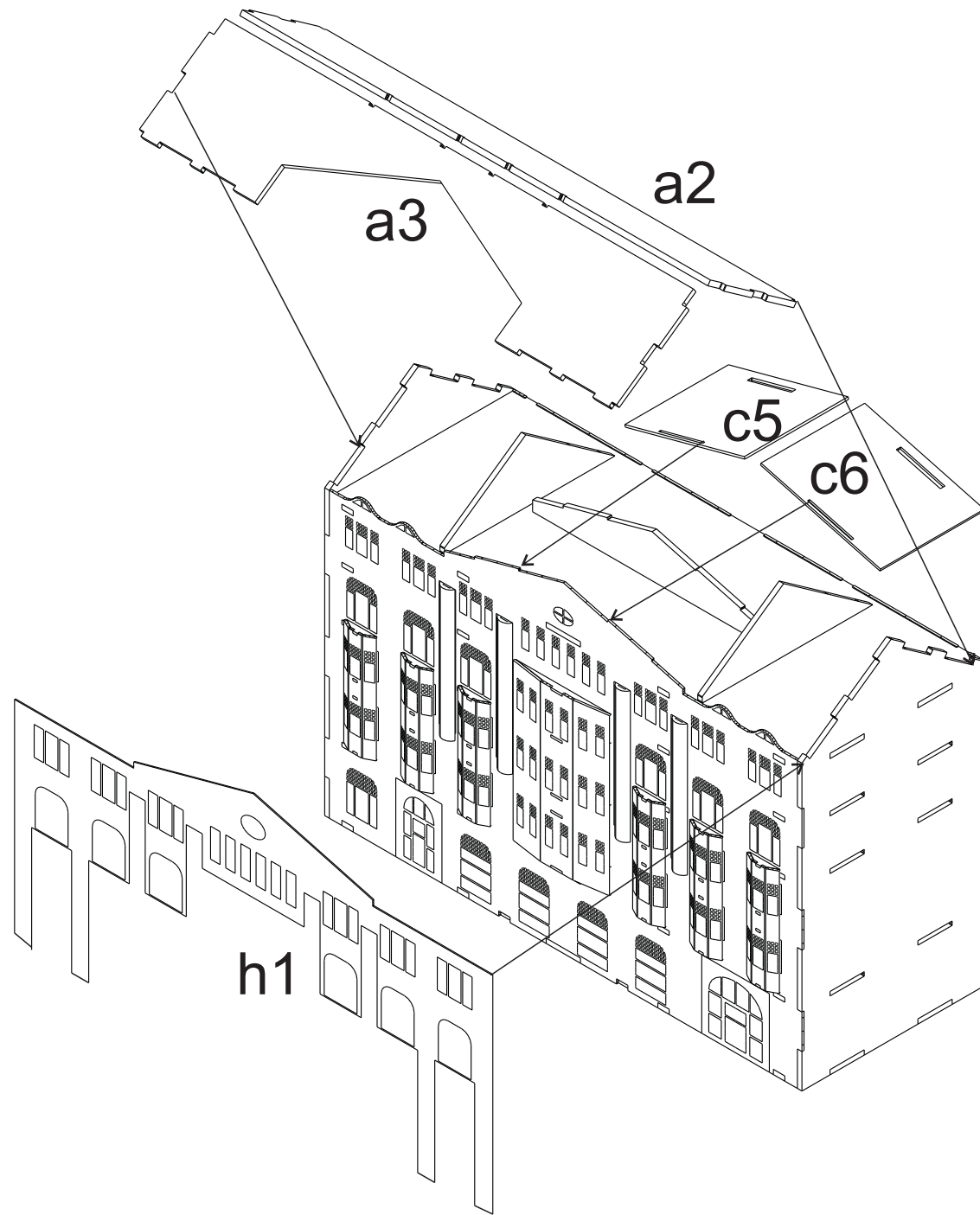



zuerst Längsseiten,  
dann Giebelseiten montieren  
*first longitudinal sides, then gable ends mount*

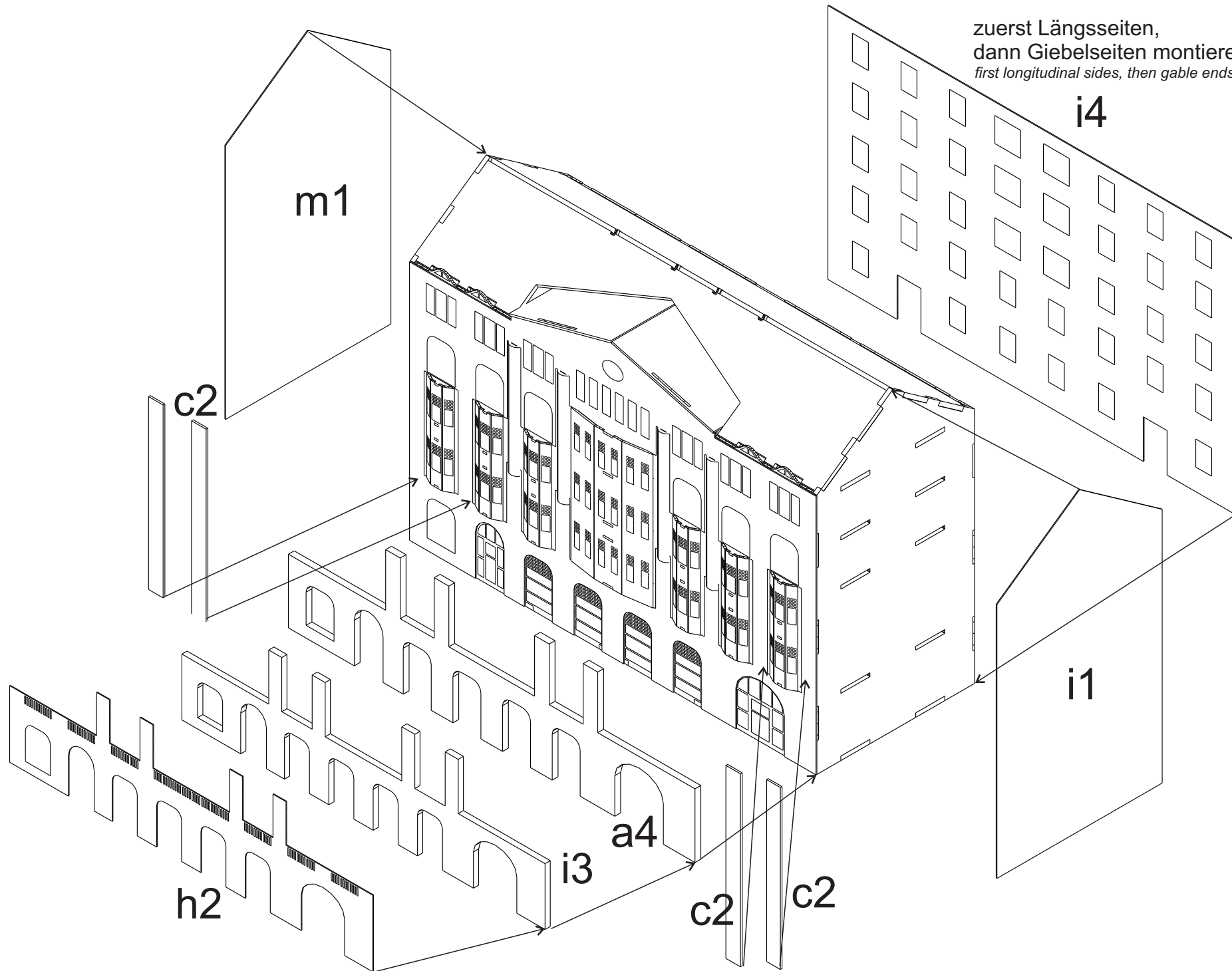

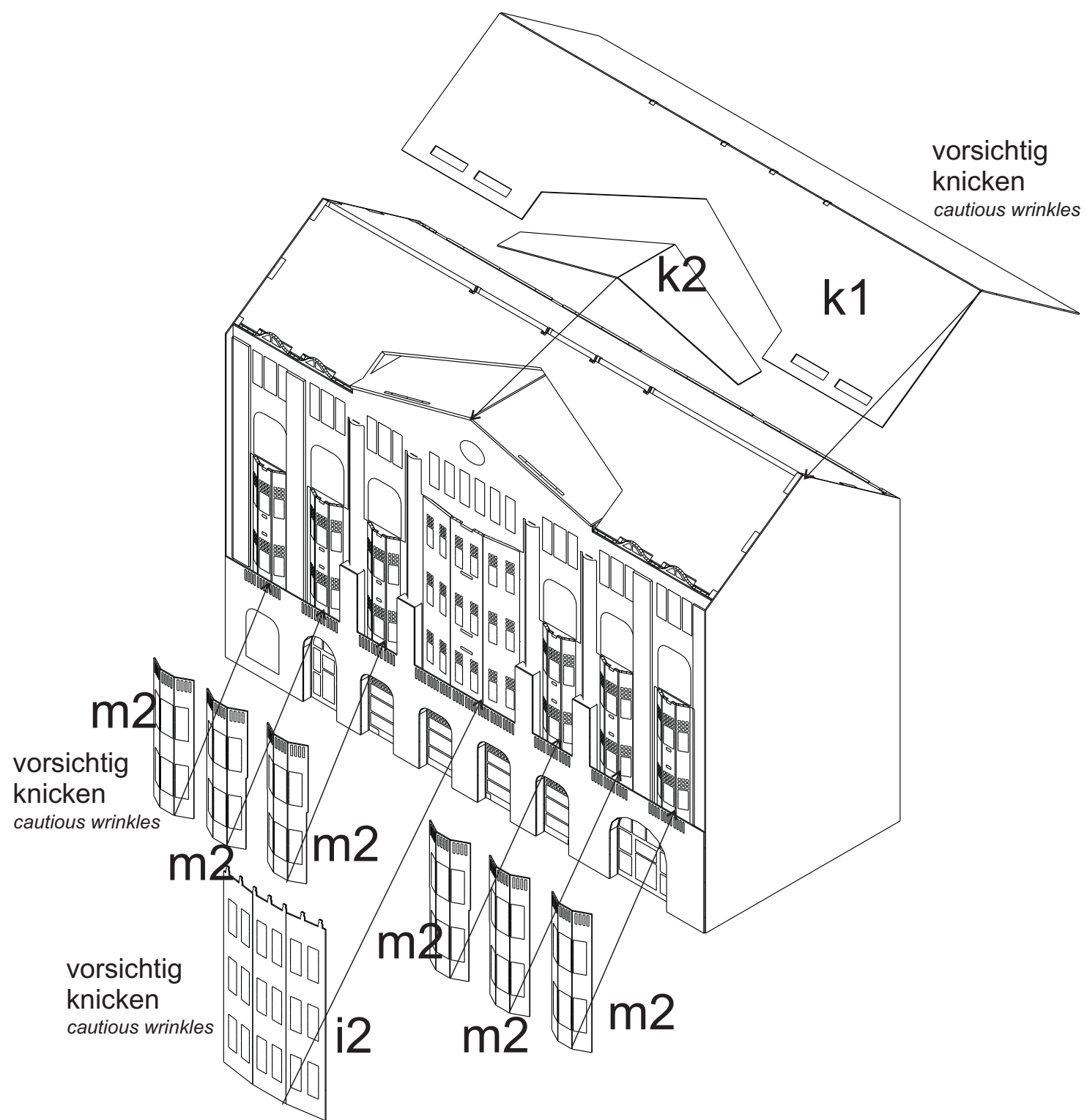

vorsichtig  
knicken  
*cautious wrinkles*

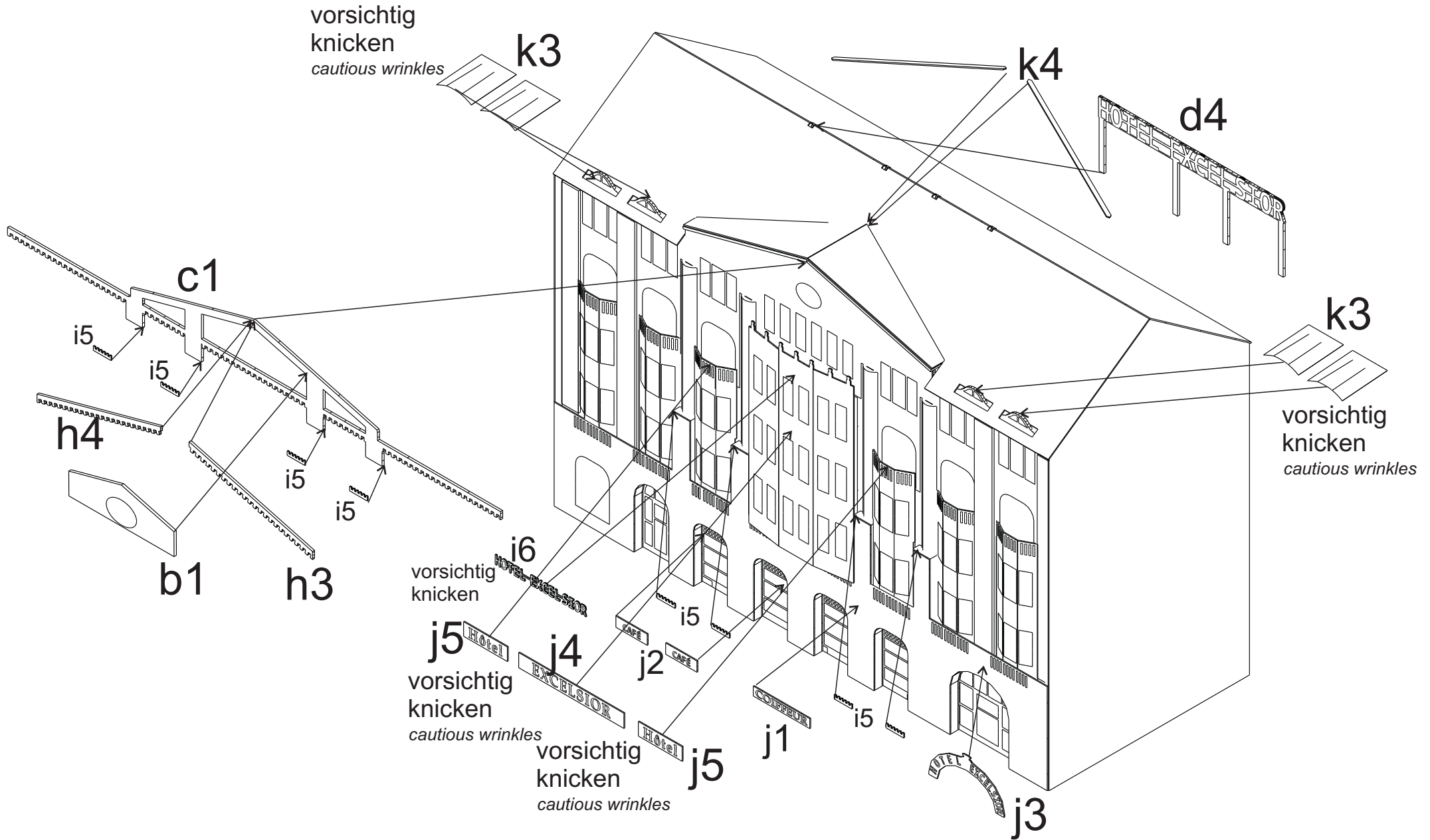

Made by



14+

